

General Description

- Logic Level Driving 4.5V
- ESD Protection
- RoHS and Halogen Free Compliant

Applications

- Load Switch

Product Summary

$V_{DS} @ T_{j,max}$	700V
I_D (at $V_{GS}=10V$)	0.04A
$R_{DS(ON)}$ (at $V_{GS}=10V$)	< 500 Ω
$R_{DS(ON)}$ (at $V_{GS}=4.5V$)	< 600 Ω

Typical ESD protection

HBM Class 2

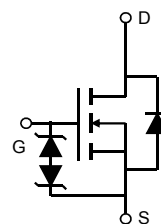
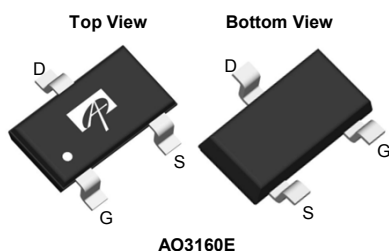

Orderable Part Number	Package Type	Form	Minimum Order Quantity
AO3160E	SOT23A	Tape & Reel	3000

Absolute Maximum Ratings $T_A=25^\circ\text{C}$ unless otherwise noted

Parameter	Symbol	Maximum	Units
Drain-Source Voltage	V_{DS}	600	V
Gate-Source Voltage	V_{GS}	± 20	V
Continuous Drain Current ^{A,F}	I_D	$T_A=25^\circ\text{C}$	0.04
		$T_A=70^\circ\text{C}$	0.03
Pulsed Drain Current ^B	I_{DM}	0.12	A
Peak diode recovery dv/dt	dv/dt	5	V/ns
Power Dissipation ^A	P_D	$T_A=25^\circ\text{C}$	1.39
		$T_A=70^\circ\text{C}$	0.89
Junction and Storage Temperature Range	T_J, T_{STG}	-55 to 150	$^\circ\text{C}$
Maximum lead temperature for soldering purpose, 1/8" from case for 5 seconds	T_L	300	$^\circ\text{C}$

Thermal Characteristics

Parameter	Symbol	Typical	Maximum	Units
Maximum Junction-to-Ambient ^A	$R_{\theta JA}$	70	90	$^\circ\text{C/W}$
Maximum Junction-to-Ambient ^A		Steady-State	100	125
Maximum Junction-to-Lead ^C	$R_{\theta JL}$	63	80	$^\circ\text{C/W}$

Electrical Characteristics (T_J=25°C unless otherwise noted)

Symbol	Parameter	Conditions	Min	Typ	Max	Units
STATIC PARAMETERS						
BV _{DSS}	Drain-Source Breakdown Voltage	I _D =250μA, V _{GS} =0V, T _J =25°C	600	-	-	V
		I _D =250μA, V _{GS} =0V, T _J =150°C	-	700	-	
BV _{DSS} /ΔT _J	Breakdown Voltage Temperature Coefficient	I _D =250μA, V _{GS} =0V	-	0.68	-	V/°C
I _{DSS}	Zero Gate Voltage Drain Current	V _{DS} =600V, V _{GS} =0V	-	-	1	μA
		V _{DS} =480V, T _J =125°C	-	-	10	
I _{GSS}	Gate-Body leakage current	V _{DS} =0V, V _{GS} =±20V	-	-	±10	μA
V _{GS(th)}	Gate Threshold Voltage	V _{DS} =5V, I _D =8μA	1.4	2	3.2	V
R _{DS(ON)}	Static Drain-Source On-Resistance	V _{GS} =10V, I _D =0.016A	-	176	500	Ω
		V _{GS} =4.5V, I _D =0.016A	-	178	600	Ω
g _{FS}	Forward Transconductance	V _{DS} =40V, I _D =0.016A	-	0.125	-	S
V _{SD}	Diode Forward Voltage	I _S =0.016A, V _{GS} =0V	-	0.76	1	V
I _S	Maximum Body-Diode Continuous Current		-	-	0.04	A
I _{SM}	Maximum Body-Diode Pulsed Current ^C		-	-	0.12	A
DYNAMIC PARAMETERS						
C _{iss}	Input Capacitance	V _{GS} =0V, V _{DS} =25V, f=1MHz	-	9.5	-	pF
C _{oss}	Output Capacitance		-	1.7	-	pF
C _{rss}	Reverse Transfer Capacitance	V _{GS} =0V, V _{DS} =25V, f=1MHz	-	0.6	-	pF
R _g	Gate resistance	f=1MHz	-	20	-	Ω
SWITCHING PARAMETERS						
Q _g	Total Gate Charge	V _{GS} =10V, V _{DS} =400V, I _D =0.01A	-	0.9	-	nC
Q _{gs}	Gate Source Charge		-	0.09	-	nC
Q _{gd}	Gate Drain Charge		-	0.49	-	nC
T _{d(on)}	Turn-On DelayTime	V _{GS} =10V, V _{DS} =300V, I _D =0.01A, R _G =6Ω	-	4	-	ns
T _r	Turn-On Rise Time		-	5	-	ns
T _{d(off)}	Turn-Off DelayTime		-	13	-	ns
T _f	Turn-Off Fall Time		-	55	-	ns
T _{rr}	Body Diode Reverse Recovery Time		I _F =0.016A, dI/dt=100A/μs,	-	105	-
Q _{rr}	Body Diode Reverse Recovery Charge	V _{DS} =300V	-	9.5	-	nC

A. The value of R_{qJA} is measured with the device mounted on 1 in² FR-4 board with 2oz. Copper, in a still air environment with T_A=25° C. The value in any given application depends on the user's specific board design.

B. Repetitive rating, pulse width limited by junction temperature.

C. The R_{qJA} is the sum of the thermal impedance from junction to lead R_{qJL} and lead to ambient.

D. The static characteristics in Figures 1 to 6 are obtained using <300 ms pulses, duty cycle 0.5% max.

E. These tests are performed with the device mounted on 1 in² FR-4 board with 2oz. Copper, in a still air environment with T_A=25° C. The SOA curve provides a single pulse rating.

F. The current rating is based on the t ≤ 10s thermal resistance rating.

APPLICATIONS OR USE AS CRITICAL COMPONENTS IN LIFE SUPPORT DEVICES OR SYSTEMS ARE NOT AUTHORIZED. AOS DOES NOT ASSUME ANY LIABILITY ARISING OUT OF SUCH APPLICATIONS OR USES OF ITS PRODUCTS. AOS RESERVES THE RIGHT TO IMPROVE PRODUCT DESIGN,FUNCTIONS AND RELIABILITY WITHOUT NOTICE.

TYPICAL ELECTRICAL AND THERMAL CHARACTERISTICS

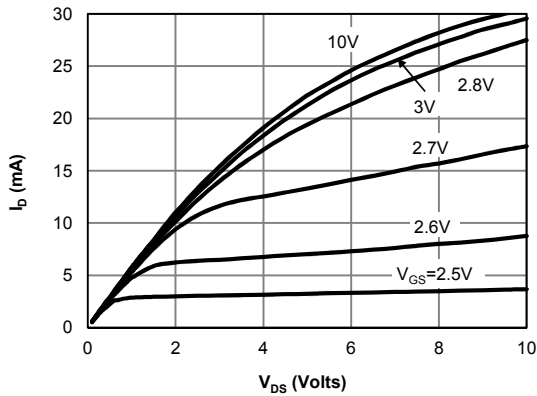

Figure 1: On-Region Characteristics

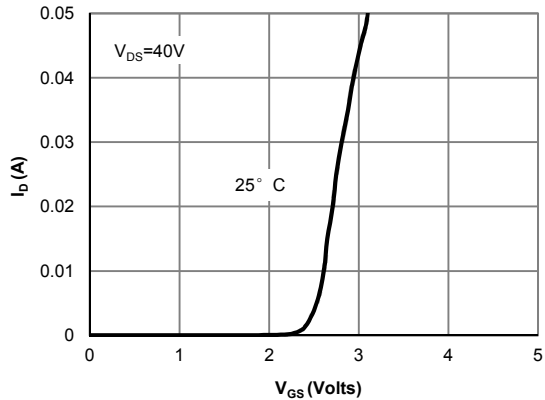

Figure 2: Transfer Characteristics

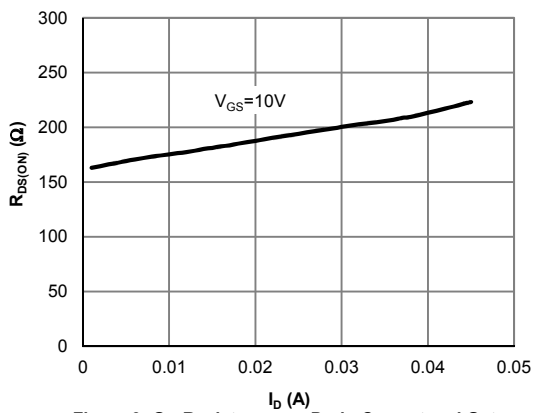

Figure 3: On-Resistance vs. Drain Current and Gate Voltage

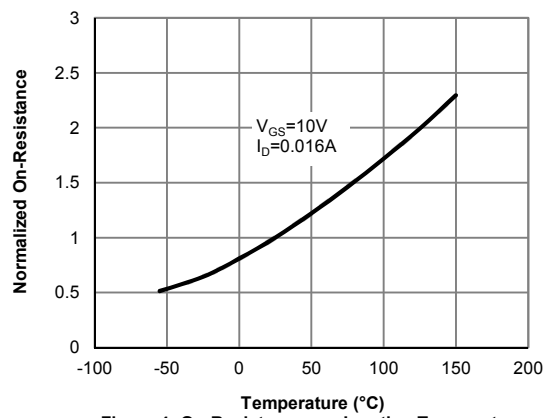

Figure 4: On-Resistance vs. Junction Temperature

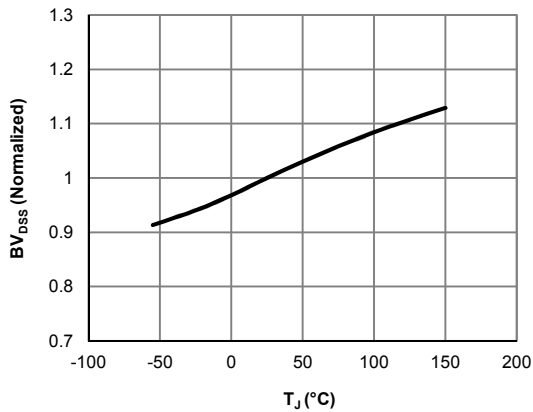

Figure 5: Break Down vs. Junction Temperature

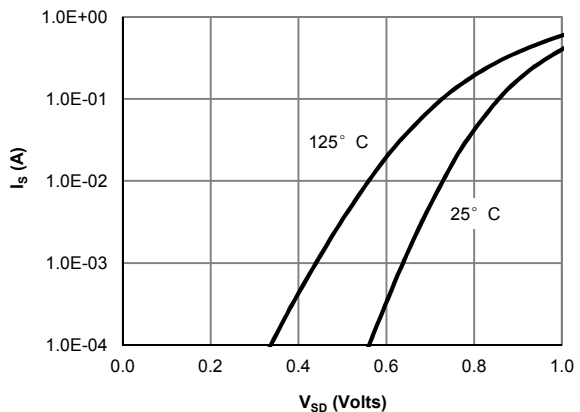

Figure 6: Body-Diode Characteristics

TYPICAL ELECTRICAL AND THERMAL CHARACTERISTICS

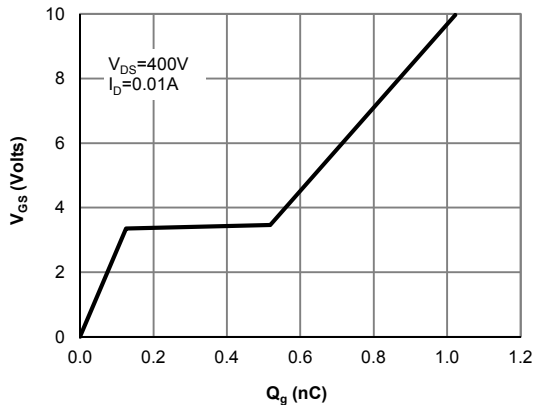

Figure 7: Gate-Charge Characteristics

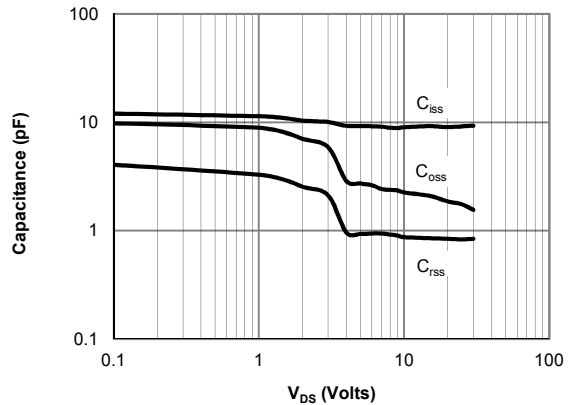

Figure 8: Capacitance Characteristics

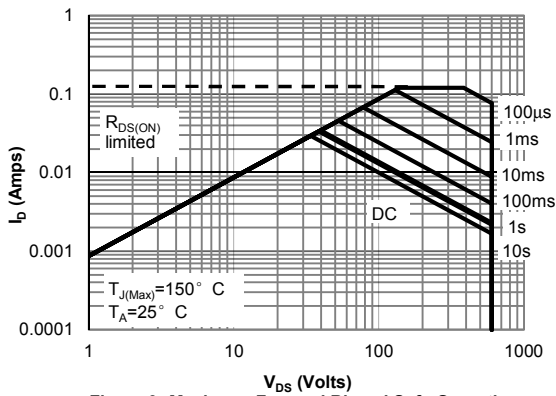

Figure 9: Maximum Forward Biased Safe Operating Area (Note E)

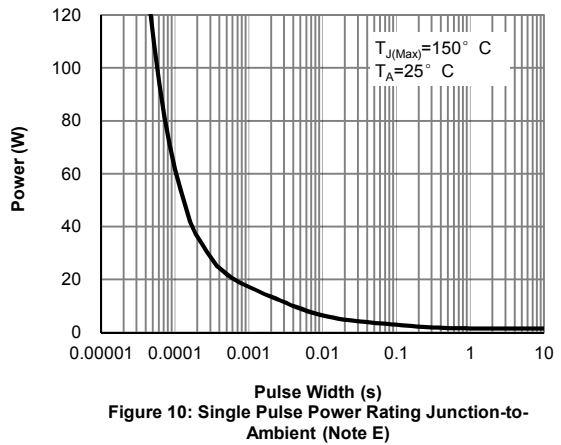

Figure 10: Single Pulse Power Rating Junction-to-Ambient (Note E)

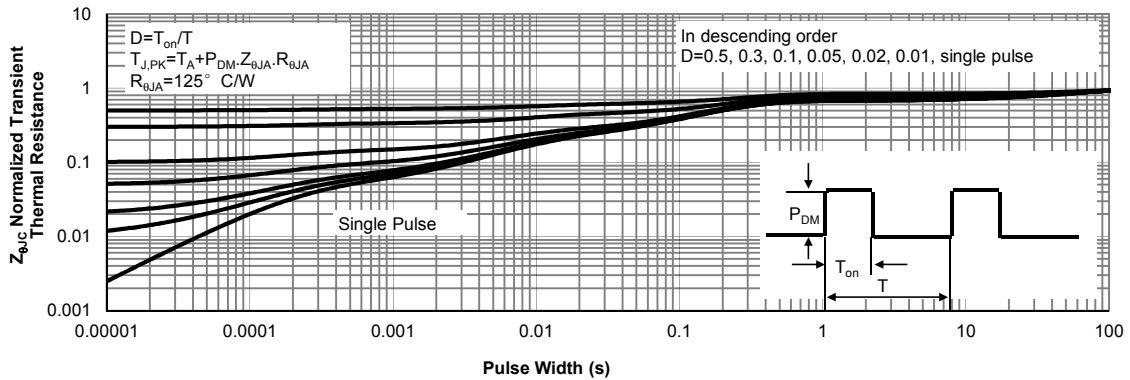
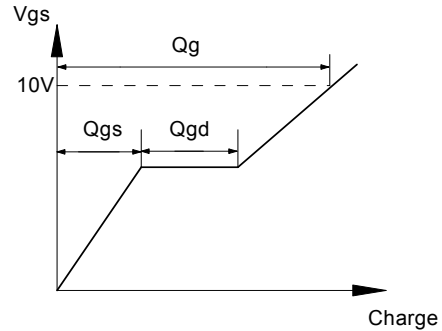
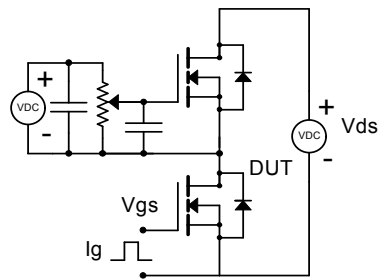
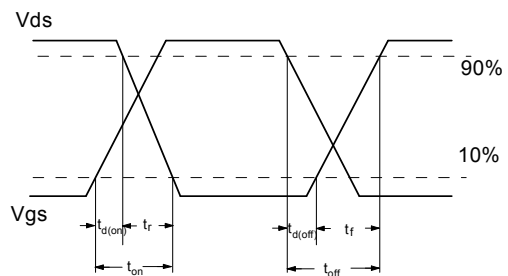
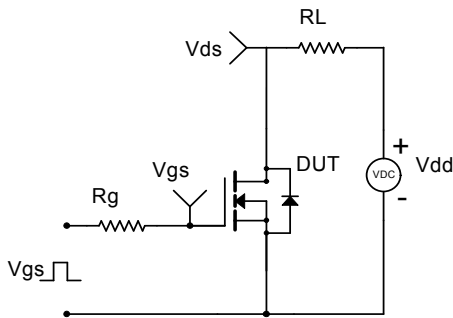

Figure 11: Normalized Maximum Transient Thermal Impedance (Note E)

Gate Charge Test Circuit & Waveform



Resistive Switching Test Circuit & Waveforms



Unclamped Inductive Switching (UIS) Test Circuit & Waveforms

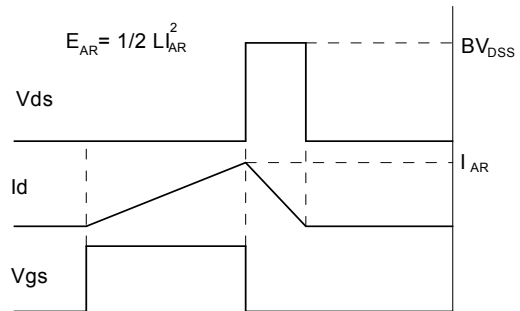
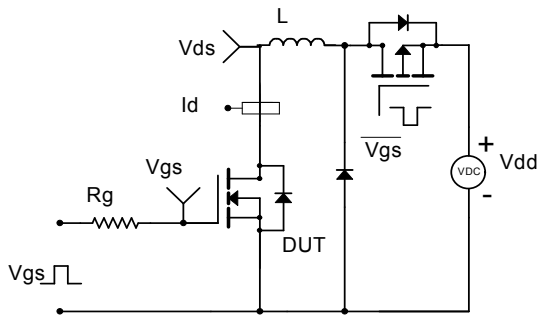

Diode Recovery Test Circuit & Waveforms

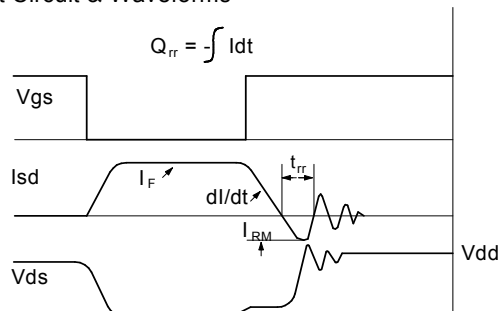
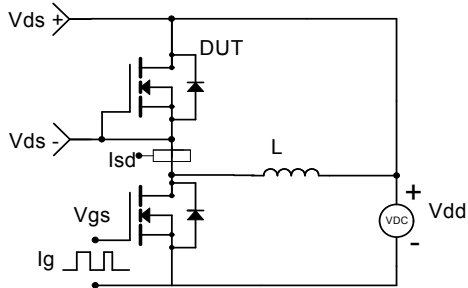

单击下面可查看定价，库存，交付和生命周期等信息

[>>AOS\(万国半导体\)](#)