

General Description

The AO4466 uses advanced trench technology to provide excellent $R_{DS(ON)}$ and low gate charge. This device is suitable for use as a load switch or in PWM applications. The source leads are separated to allow a Kelvin connection to the source, which may be used to bypass the source inductance.

* RoHS and Halogen-Free Compliant

Product Summary

V_{DS} (V) = 30V
 I_D = 10A ($V_{GS} = 10V$)
 $R_{DS(ON)} < 23m\Omega$ ($V_{GS} = 10V$)
 $R_{DS(ON)} < 35m\Omega$ ($V_{GS} = 4.5V$)

100% UIS Tested
 100% Rg Tested



SOIC-8

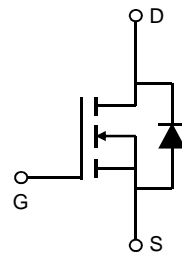
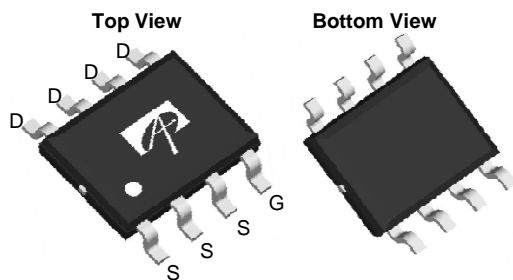

Absolute Maximum Ratings $T_A=25^\circ\text{C}$ unless otherwise noted

Parameter	Symbol	Maximum	Units
Drain-Source Voltage	V_{DS}	30	V
Gate-Source Voltage	V_{GS}	± 20	V
Continuous Drain Current ^{AF}	I_D	10	A
		$T_A=70^\circ\text{C}$	
Pulsed Drain Current ^B	I_{DM}	64	
Power Dissipation	P_D	3.1	W
		$T_A=70^\circ\text{C}$	
Avalanche Current ^{B, G}	I_{AR}	12	A
Repetitive avalanche energy 0.1mH ^{B, G}	E_{AR}	7	mJ
Junction and Storage Temperature Range	T_J, T_{STG}	-55 to 150	$^\circ\text{C}$

Thermal Characteristics

Parameter	Symbol	Typ	Max	Units
Maximum Junction-to-Ambient ^A	$R_{\theta JA}$	36	40	$^\circ\text{C/W}$
		Steady-State	62	
Maximum Junction-to-Lead ^C	$R_{\theta JL}$	18	24	$^\circ\text{C/W}$

Electrical Characteristics (T_J=25°C unless otherwise noted)

Symbol	Parameter	Conditions	Min	Typ	Max	Units
STATIC PARAMETERS						
BV _{DSS}	Drain-Source Breakdown Voltage	I _D =250μA, V _{GS} =0V	30			V
I _{DSS}	Zero Gate Voltage Drain Current	V _{DS} =30 V _{GS} =0V T _J =55°C			1 5	μA
I _{GSS}	Gate-Body leakage current	V _{DS} =0V, V _{GS} = ±20V			100	nA
V _{GS(th)}	Gate Threshold Voltage	V _{DS} =V _{GS} I _D =250μA	1.5	2.1	2.6	V
I _{D(ON)}	On state drain current	V _{GS} =4.5V, V _{DS} =5V	64			A
R _{DS(ON)}	Static Drain-Source On-Resistance	V _{GS} =10V, I _D =10A T _J =125°C		16.7 24.3	23 30	mΩ
		V _{GS} =4.5V, I _D =5A		23.7	35	
g _{FS}	Forward Transconductance	V _{DS} =5V, I _D =10A		17		S
V _{SD}	Diode Forward Voltage	I _S =1A, V _{GS} =0V		0.75	1	V
I _S	Maximum Body-Diode Continuous Current				2.4	A
DYNAMIC PARAMETERS						
C _{iss}	Input Capacitance	V _{GS} =0V, V _{DS} =15V, f=1MHz	298	373	448	pF
C _{oss}	Output Capacitance		46	67	88	pF
C _{rss}	Reverse Transfer Capacitance		24	41	58	pF
R _g	Gate resistance	V _{GS} =0V, V _{DS} =0V, f=1MHz	0.6	1.8	2.8	Ω
SWITCHING PARAMETERS						
Q _{g(10V)}	Total Gate Charge	V _{GS} =10V, V _{DS} =15V, I _D =10A	5.7	7.1	8.6	nC
Q _{g(4.5V)}	Total Gate Charge		2.7	3.5	4.2	nC
Q _{gs}	Gate Source Charge			1.2		nC
Q _{gd}	Gate Drain Charge			1.6		nC
t _{D(on)}	Turn-On DelayTime	V _{GS} =10V, V _{DS} =15V, R _L =1.5Ω, R _{GEN} =3Ω		4.3		ns
t _r	Turn-On Rise Time			2.8		ns
t _{D(off)}	Turn-Off DelayTime			15.8		ns
t _f	Turn-Off Fall Time			3		ns
t _{rr}	Body Diode Reverse Recovery Time		I _F =10A, dI/dt=100A/μs	8.4	10.5	12.6
Q _{rr}	Body Diode Reverse Recovery Charge	I _F =10A, dI/dt=100A/μs	3.6	4.5	5.4	nC
t _{rr}	Body Diode Reverse Recovery Time	I _F =10A, dI/dt=500A/μs	4.7	6.0	7.2	ns
Q _{rr}	Body Diode Reverse Recovery Charge	I _F =10A, dI/dt=500A/μs	5.3	6.6	8	nC

A: The value of R_{θJA} is measured with the device mounted on 1 in 2 FR-4 board with 2oz. Copper, in a still air environment with T_A=25° C. The value in any given application depends on the user's specific board design.

B: Repetitive rating, pulse width limited by junction temperature.

C: The R_{θJA} is the sum of the thermal impedance from junction to lead R_{θJL} and lead to ambient.

D: The static characteristics in Figures 1 to 6 are obtained using <300 μs pulses, duty cycle 0.5% max.

E: These tests are performed with the device mounted on 1 in 2 FR-4 board with 2oz. Copper, in a still air environment with T_A=25° C. The SOA curve provides a single pulse rating.

F: The current rating is based on the t ≤ 10s junction to ambient thermal resistance rating.

G: L=100uH, V_{DD}=0V, R_G=0Ω, rated V_{DS}=30V and V_{GS}=10V

Rev 9: May. 2012

THIS PRODUCT HAS BEEN DESIGNED AND QUALIFIED FOR THE CONSUMER MARKET. APPLICATIONS OR USES AS CRITICAL COMPONENTS IN LIFE SUPPORT DEVICES OR SYSTEMS ARE NOT AUTHORIZED. AOS DOES NOT ASSUME ANY LIABILITY ARISING OUT OF SUCH APPLICATIONS OR USES OF ITS PRODUCTS. AOS RESERVES THE RIGHT TO IMPROVE PRODUCT DESIGN, FUNCTIONS AND RELIABILITY WITHOUT NOTICE.

TYPICAL ELECTRICAL AND THERMAL CHARACTERISTICS

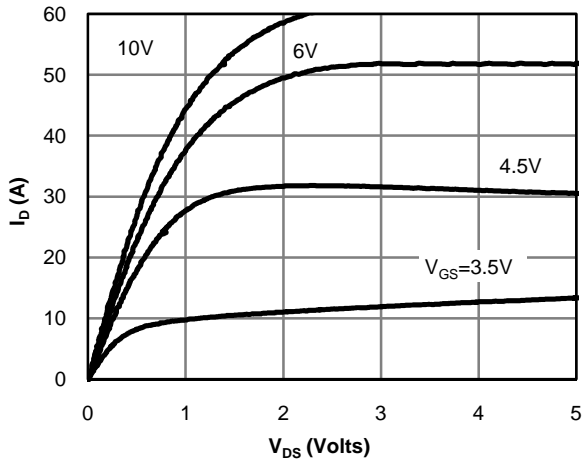

Fig 1: On-Region Characteristics

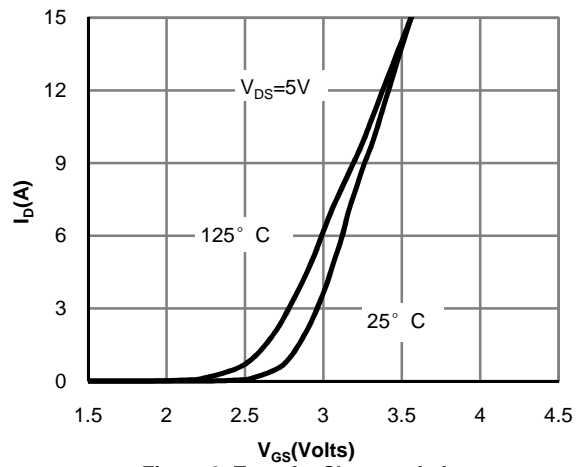

Figure 2: Transfer Characteristics

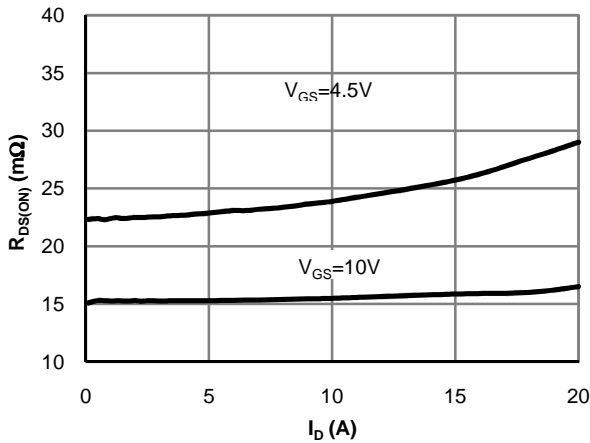

Figure 3: On-Resistance vs. Drain Current and Gate Voltage

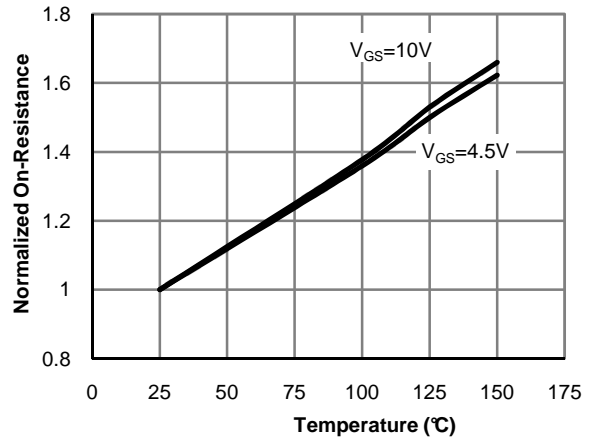

Figure 4: On-Resistance vs. Junction Temperature

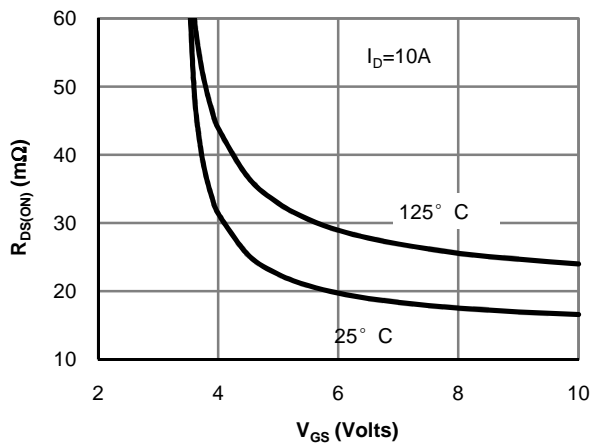

Figure 5: On-Resistance vs. Gate-Source Voltage

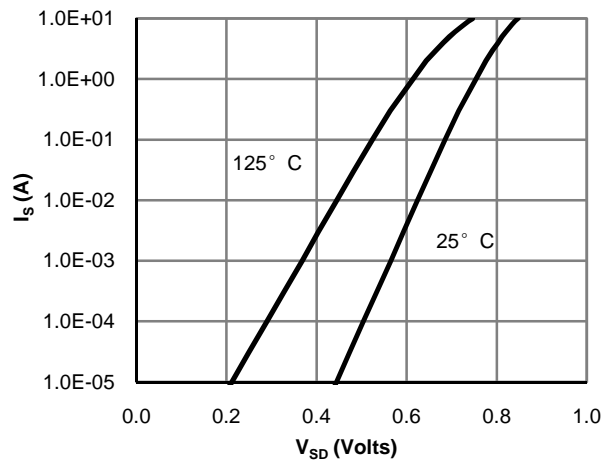

Figure 6: Body-Diode Characteristics

TYPICAL ELECTRICAL AND THERMAL CHARACTERISTICS

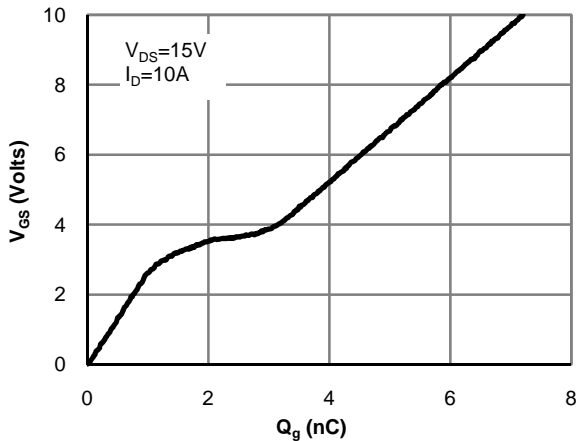

Figure 7: Gate-Charge Characteristics

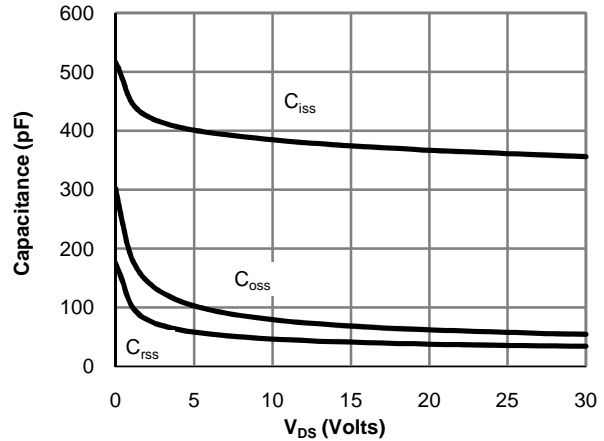

Figure 8: Capacitance Characteristics

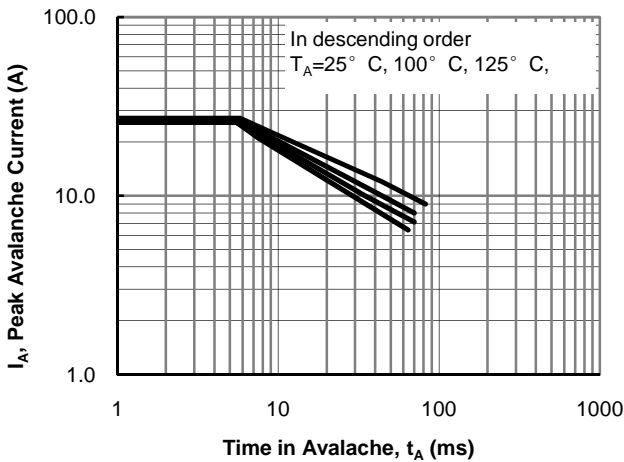

Figure 9: Single Pulse Avalanche Capability

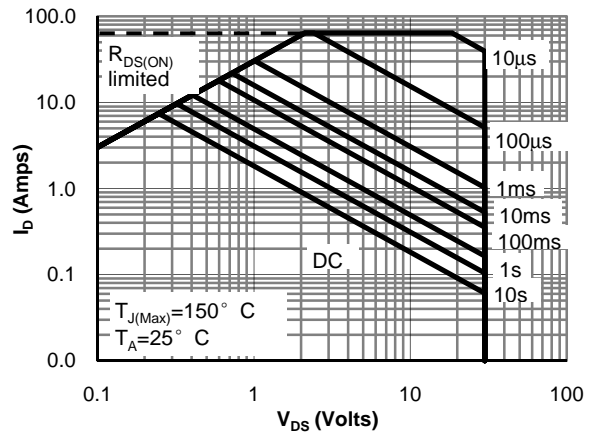

Figure 10: Maximum Forward Biased Safe Operating Area (Note E)

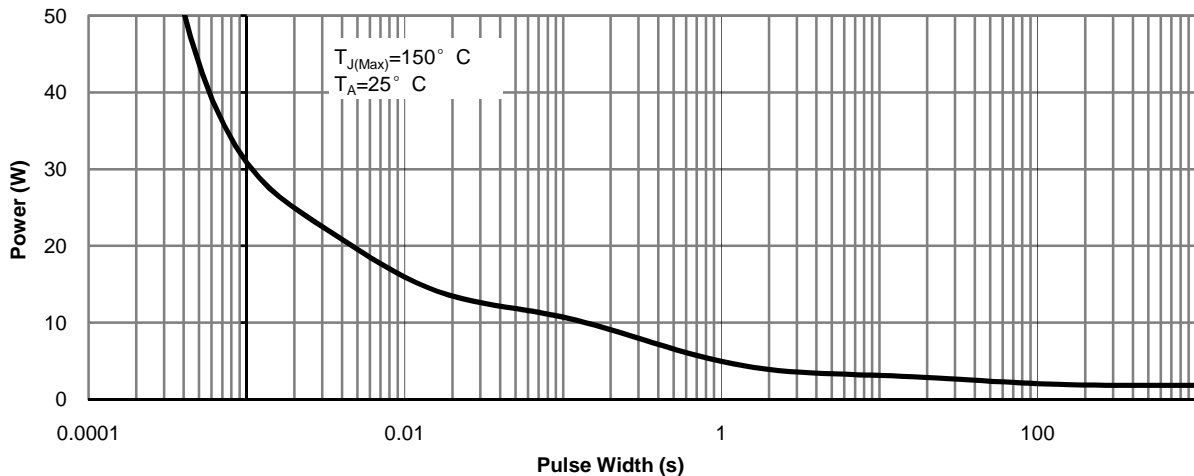
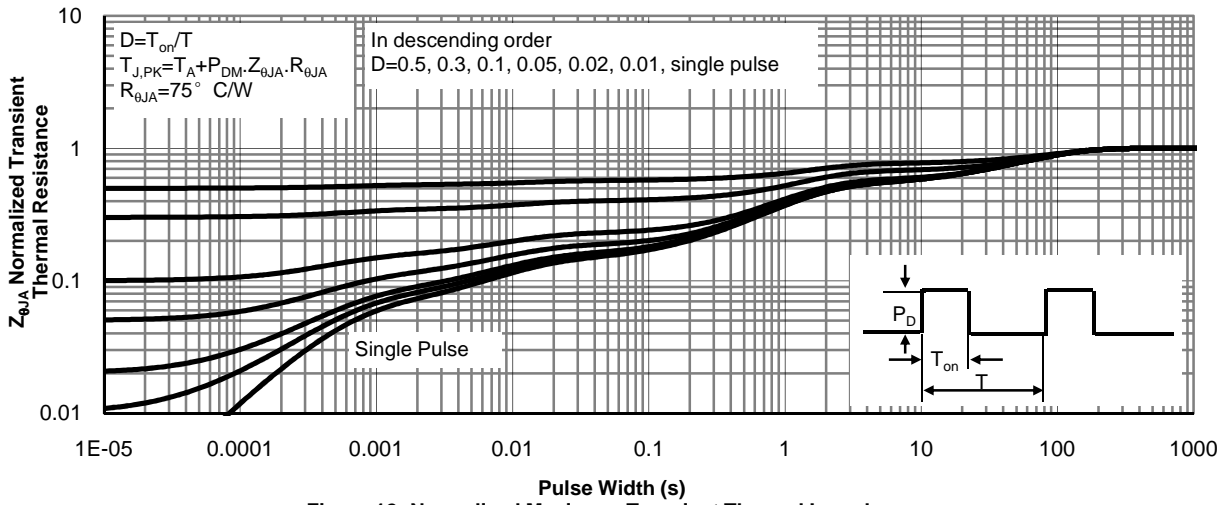

Figure 11: Single Pulse Power Rating Junction-to-Ambient (Note E)



TYPICAL ELECTRICAL AND THERMAL CHARACTERISTICS



Gate Charge Test Circuit & Waveform

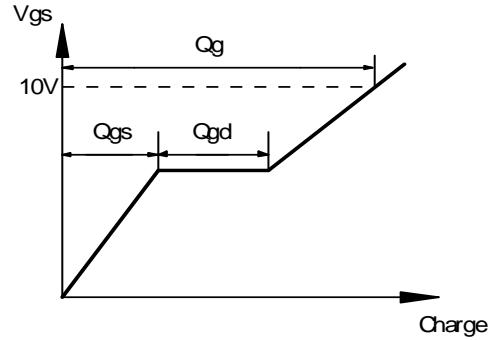
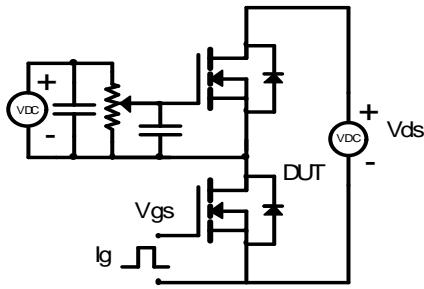

Resistive Switching Test Circuit & Waveforms

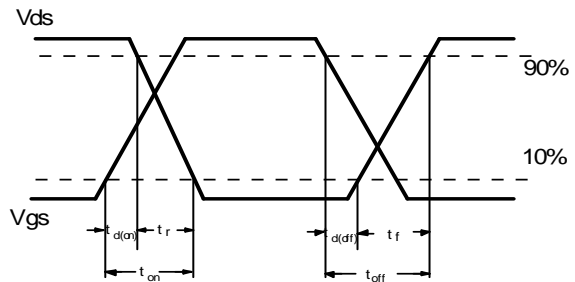
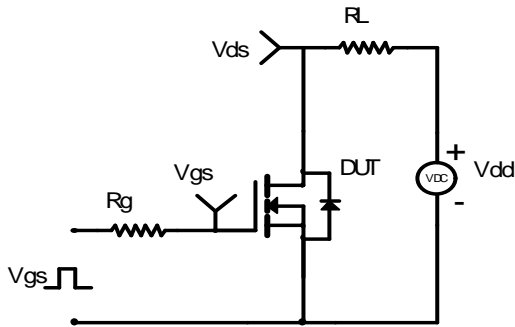

Unclamped Inductive Switching (UIS) Test Circuit & Waveforms

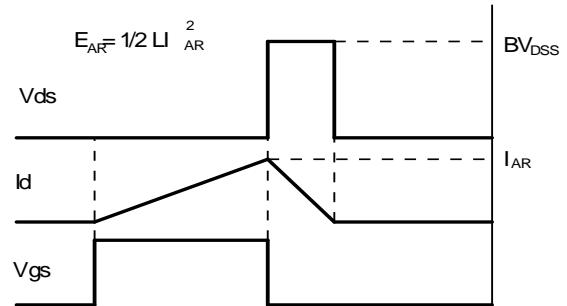
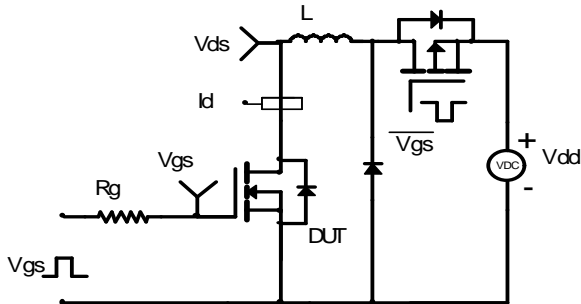

Diode Recovery Test Circuit & Waveforms

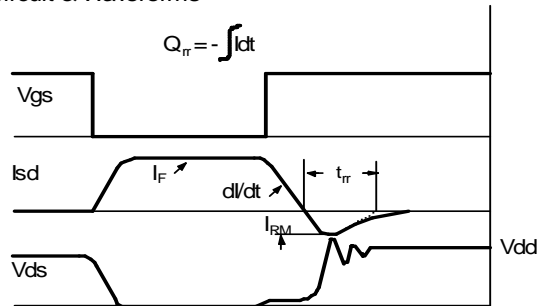
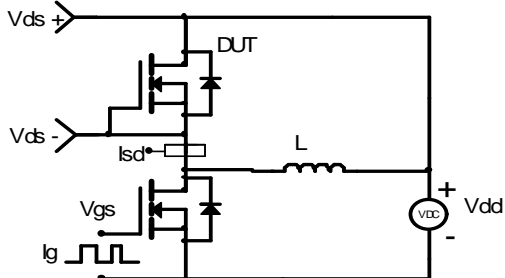

单击下面可查看定价，库存，交付和生命周期等信息

[>>AOS\(万代\)](#)