

General Description

AO4772 uses advanced trench technology to provide excellent $R_{DS(ON)}$ and low gate charge. A Schottky diode is provided to facilitate the implementation of a bidirectional blocking switch, or for "standard buck" DC-DC conversion applications.

Product Summary

V_{DS}	30V
I_D (at $V_{GS}=10V$)	6A
$R_{DS(ON)}$ (at $V_{GS}=10V$)	< 30m Ω
$R_{DS(ON)}$ (at $V_{GS} = 4.5V$)	< 42m Ω

Schottky

V_{KA}	30V
I_F	4A
V_F (at $I_F=1A$)	<0.45V

100% UIS Tested
100% R_g Tested

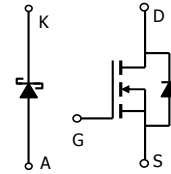
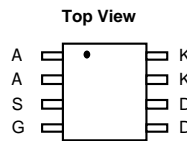
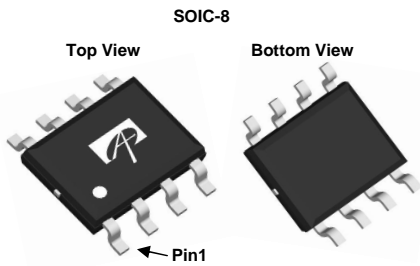

Absolute Maximum Ratings $T_A=25^\circ C$ unless otherwise noted

Parameter	Symbol	MOSFET	Schottky	Units
Drain-Source Voltage	V_{DS}	30		V
Gate-Source Voltage	V_{GS}	± 20		V
Continuous Drain Current	I_D	$T_A=25^\circ C$	6	A
		$T_A=70^\circ C$	5	
Pulsed Drain Current ^C	I_{DM}	30		
Avalanche Current ^C	I_{AS}, I_{AR}	10		A
Avalanche energy $L=0.1mH$ ^C	E_{AS}, E_{AR}	5		mJ
Schottky reverse voltage	V_{KA}		30	V
Continuous Forward Current	I_F	$T_A=25^\circ C$	4	A
		$T_A=70^\circ C$	3	
Power Dissipation ^B	P_D	$T_A=25^\circ C$	2	W
		$T_A=70^\circ C$	1.3	
Junction and Storage Temperature Range	T_J, T_{STG}	-55 to 150	-55 to 150	$^\circ C$

Thermal Characteristics

Parameter: MOSFET	Symbol	Typ	Max	Units
Maximum Junction-to-Ambient ^A	$R_{\theta JA}$	48	62.5	$^\circ C/W$
Maximum Junction-to-Ambient ^{A,D}		Steady-State	74	90
Maximum Junction-to-Lead	$R_{\theta JL}$	32	40	$^\circ C/W$
Parameter: Schottky				
Maximum Junction-to-Ambient ^A	$R_{\theta JA}$	48	62.5	$^\circ C/W$
Maximum Junction-to-Ambient ^{A,D}		Steady-State	74	90
Maximum Junction-to-Lead	$R_{\theta JL}$	31	40	$^\circ C/W$

Electrical Characteristics (T_J=25°C unless otherwise noted)

Symbol	Parameter	Conditions	Min	Typ	Max	Units
STATIC PARAMETERS						
BV _{DSS}	Drain-Source Breakdown Voltage	I _D =250μA, V _{GS} =0V	30			V
I _{DSS}	Zero Gate Voltage Drain Current	V _{DS} =30V, V _{GS} =0V T _J =55°C			1 5	μA
I _{GSS}	Gate-Body leakage current	V _{DS} =0V, V _{GS} = ±20V			100	nA
V _{GS(th)}	Gate Threshold Voltage	V _{DS} =V _{GS} , I _D =250μA	1.2	1.8	2.4	V
I _{D(ON)}	On state drain current	V _{GS} =10V, V _{DS} =5V	25			A
R _{DS(ON)}	Static Drain-Source On-Resistance	V _{GS} =10V, I _D =6A T _J =125°C		25 40	30 48	mΩ
		V _{GS} =4.5V, I _D =5A		33	42	mΩ
g _{FS}	Forward Transconductance	V _{DS} =5V, I _D =6A		15		S
V _{SD}	Diode Forward Voltage	I _S =1A, V _{GS} =0V		0.8	1	V
I _S	Maximum Body-Diode Continuous Current				2.5	A
DYNAMIC PARAMETERS						
C _{iss}	Input Capacitance	V _{GS} =0V, V _{DS} =15V, f=1MHz		255	310	pF
C _{oss}	Output Capacitance			45		pF
C _{rss}	Reverse Transfer Capacitance			35	50	pF
R _g	Gate resistance	V _{GS} =0V, V _{DS} =0V, f=1MHz	1.6	3.25	4.9	Ω
SWITCHING PARAMETERS						
Q _g (10V)	Total Gate Charge	V _{GS} =10V, V _{DS} =15V, I _D =6A	4	5.2	6.3	nC
Q _g (4.5V)	Total Gate Charge		2	2.55	3.2	nC
Q _{gs}	Gate Source Charge			0.85		nC
Q _{gd}	Gate Drain Charge			1.3		nC
t _{D(on)}	Turn-On DelayTime	V _{GS} =10V, V _{DS} =15V, R _L =2.5Ω, R _{GEN} =3Ω		4.5		ns
t _r	Turn-On Rise Time			2.5		ns
t _{D(off)}	Turn-Off DelayTime			14.5		ns
t _f	Turn-Off Fall Time			3.5		ns
t _{rr}	Body Diode Reverse Recovery Time	I _F =6A, dI/dt=100A/μs		8.5	12	ns
Q _{rr}	Body Diode Reverse Recovery Charge	I _F =6A, dI/dt=100A/μs		2.2	3	nC
SCHOTTKY PARAMETERS						
V _F	Forward Voltage Drop	I _F =1A		0.34	0.45	V
I _{rm}	Maximum reverse leakage current	V _R =24V			0.1	mA
		V _R =24V, T _J =125°C			80	
C _T	Junction Capacitance	V _R =15V		110		pF

A. The value of R_{θJA} is measured with the device mounted on 1in² FR-4 board with 2oz. Copper, in a still air environment with T_A=25°C. The value in any given application depends on the user's specific board design.

B. The power dissipation P_D is based on T_{J(MAX)}=150°C, using ≤ 10s junction-to-ambient thermal resistance.

C. Repetitive rating, pulse width limited by junction temperature T_{J(MAX)}=150°C. Ratings are based on low frequency and duty cycles to keep initial T_J=25°C.

D. The R_{θJA} is the sum of the thermal impedance from junction to lead R_{θJL} and lead to ambient.

E. The static characteristics in Figures 1 to 6 are obtained using <300μs pulses, duty cycle 0.5% max.

F. These curves are based on the junction-to-ambient thermal impedance which is measured with the device mounted on 1in² FR-4 board with 2oz. Copper, assuming a maximum junction temperature of T_{J(MAX)}=150°C. The SOA curve provides a single pulse rating.

THIS PRODUCT HAS BEEN DESIGNED AND QUALIFIED FOR THE CONSUMER MARKET. APPLICATIONS OR USES AS CRITICAL COMPONENTS IN LIFE SUPPORT DEVICES OR SYSTEMS ARE NOT AUTHORIZED. AOS DOES NOT ASSUME ANY LIABILITY ARISING OUT OF SUCH APPLICATIONS OR USES OF ITS PRODUCTS. AOS RESERVES THE RIGHT TO IMPROVE PRODUCT DESIGN, FUNCTIONS AND RELIABILITY WITHOUT NOTICE.

TYPICAL ELECTRICAL AND THERMAL CHARACTERISTICS

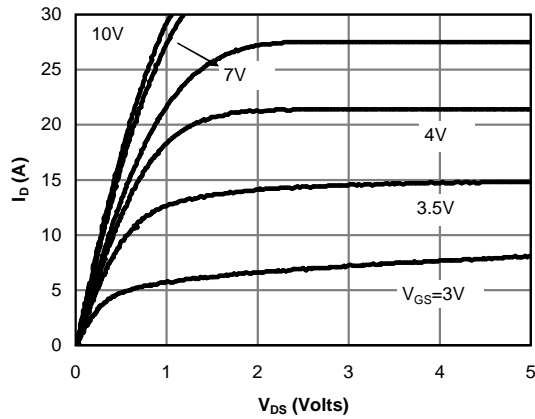

Fig 1: On-Region Characteristics (Note E)

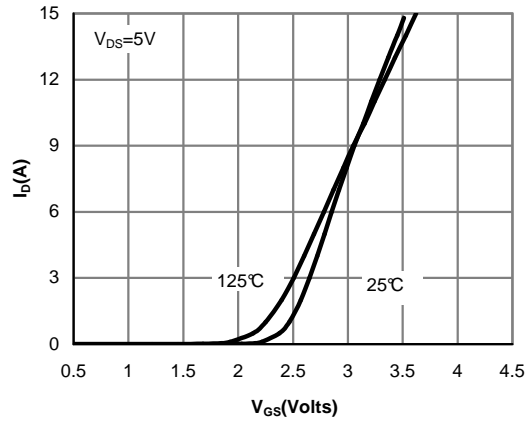

Figure 2: Transfer Characteristics (Note E)

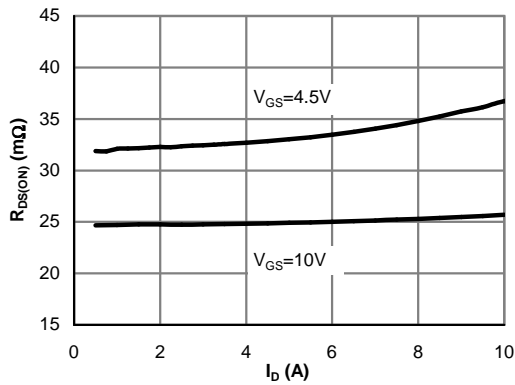

Figure 3: On-Resistance vs. Drain Current and Gate Voltage (Note E)

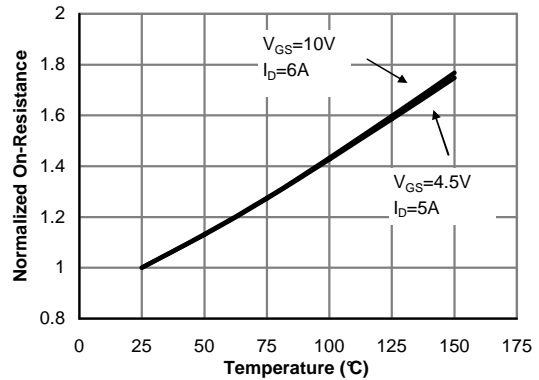

Figure 4: On-Resistance vs. Junction Temperature (Note E)

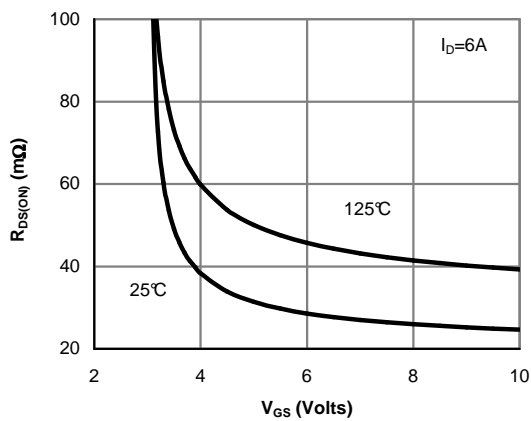

Figure 5: On-Resistance vs. Gate-Source Voltage (Note E)

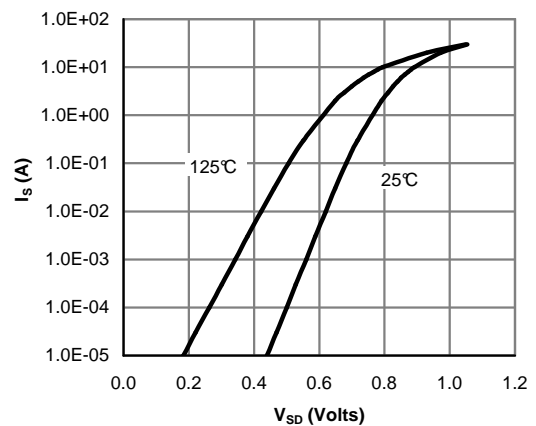

Figure 6: Body-Diode Characteristics (Note E)

TYPICAL ELECTRICAL AND THERMAL CHARACTERISTICS

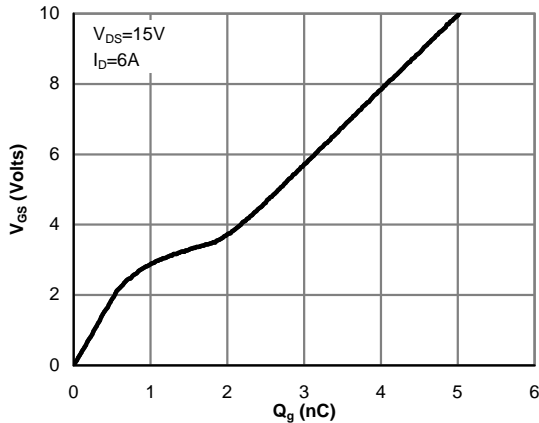

Figure 7: Gate-Charge Characteristics

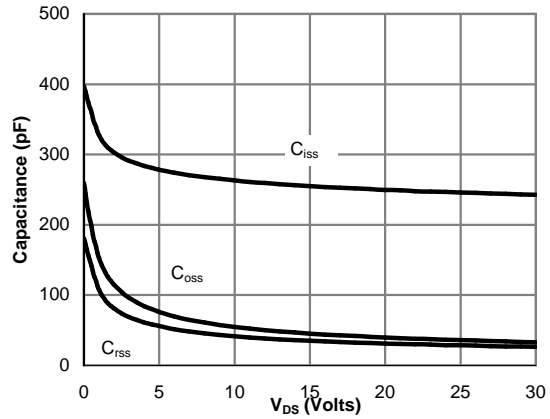

Figure 8: Capacitance Characteristics

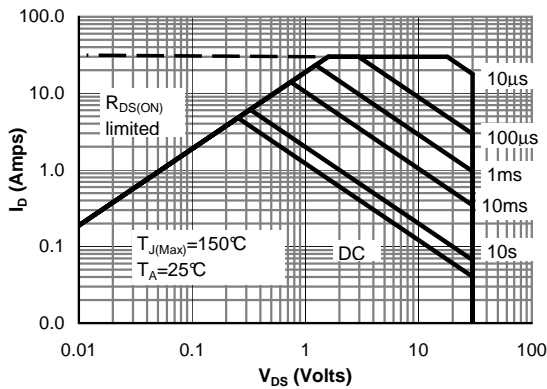

Figure 9: Maximum Forward Biased Safe Operating Area (Note F)

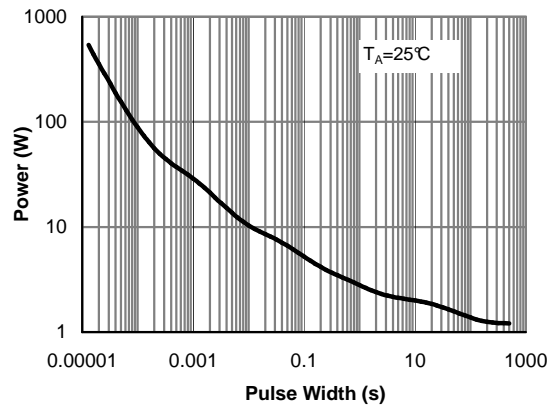

Figure 10: Single Pulse Power Rating Junction-to-Ambient (Note F)

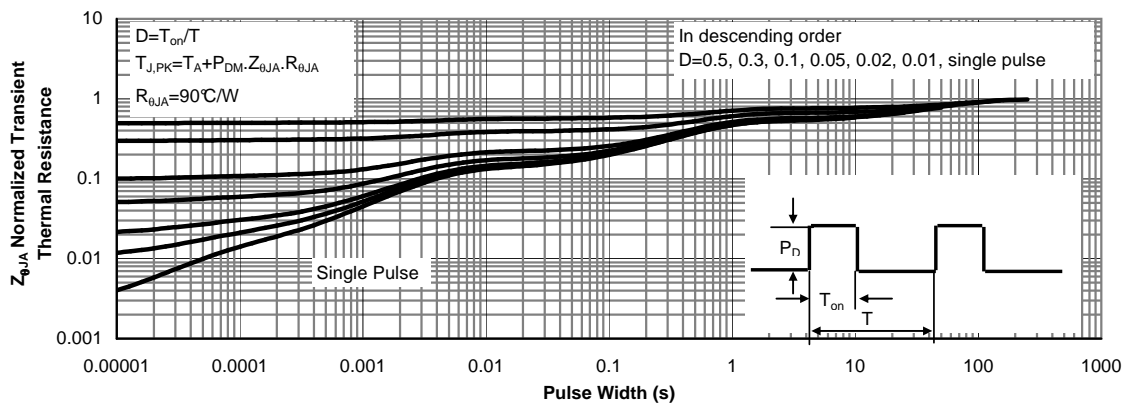

Figure 11: Normalized Maximum Transient Thermal Impedance (Note F)

TYPICAL ELECTRICAL AND THERMAL CHARACTERISTICS

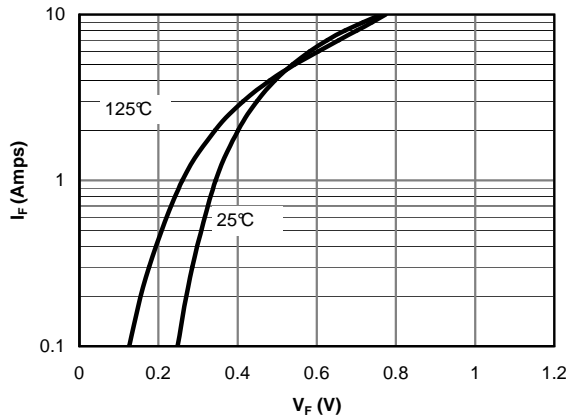

Figure 12: Schottky Forward Characteristics

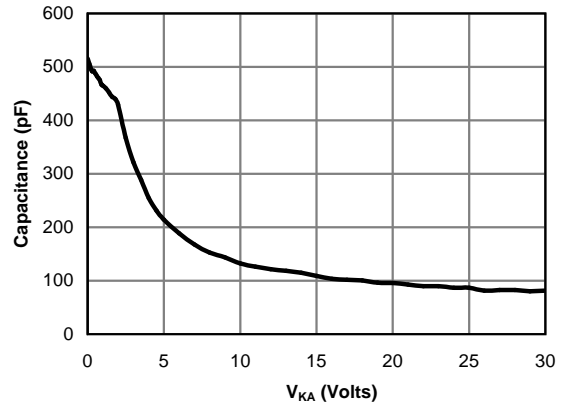

Figure 13: Schottky Capacitance Characteristics

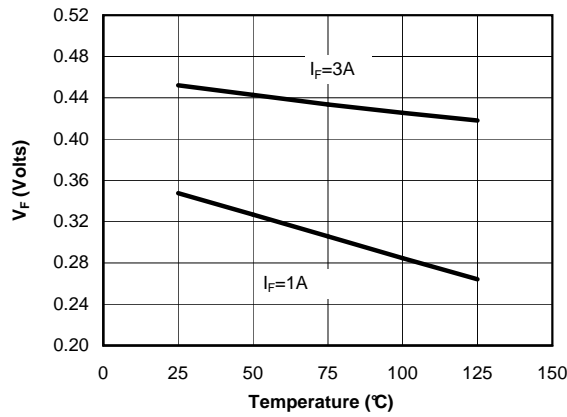

Figure 14: Schottky Forward Drop vs. Junction Temperature

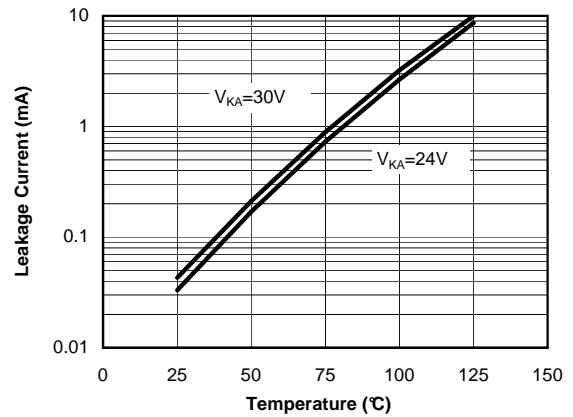
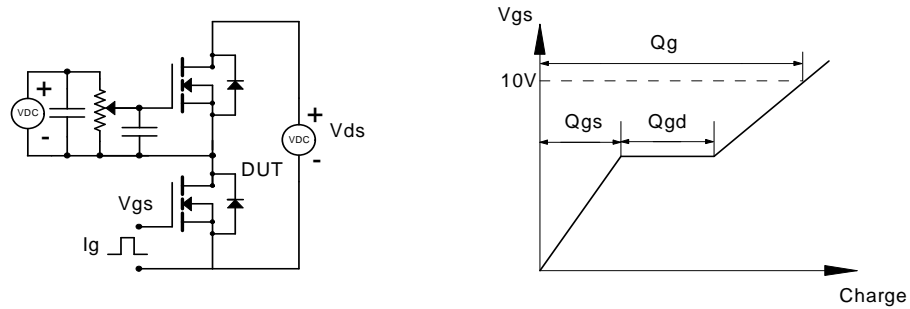
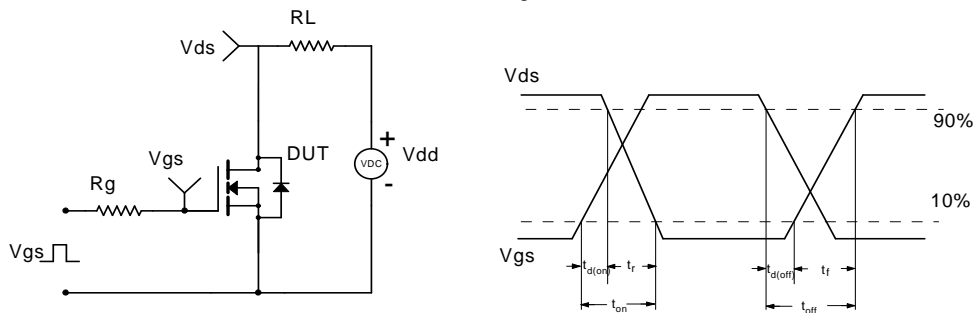

Figure 15: Schottky Leakage Current vs. Junction Temperature

Gate Charge Test Circuit & Waveform



Resistive Switching Test Circuit & Waveforms



Unclamped Inductive Switching (UIS) Test Circuit & Waveforms

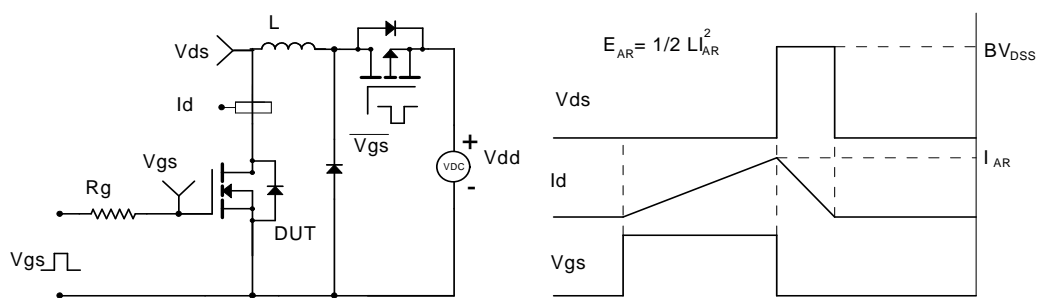

Diode Recovery Test Circuit & Waveforms

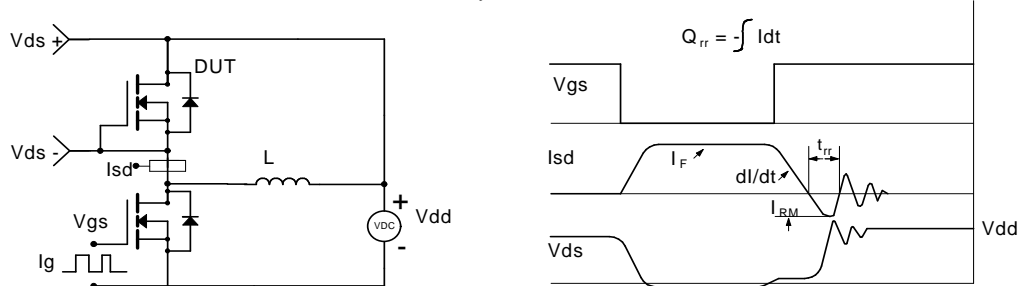

单击下面可查看定价，库存，交付和生命周期等信息

[>>AOS\(万代\)](#)