

### General Description

The AO4924 uses advanced trench technology to provide excellent  $R_{DS(ON)}$  and low gate charge. The two MOSFETs make a compact and efficient switch and synchronous rectifier combination for use in DC-DC converters. A monolithically integrated Schottky diode in parallel with the synchronous MOSFET to boost efficiency further.

### Product Summary

FET1	FET2
$V_{DS} (V) = 30V$	$V_{DS}(V) = 30V$
$I_D = 9A$	$I_D=7.3A$ ( $V_{GS} = 10V$ )
$R_{DS(ON)} < 15.8m\Omega$	$<24m\Omega$ ( $V_{GS} = 10V$ )
$R_{DS(ON)} < 19.5m\Omega$	$<29m\Omega$ ( $V_{GS} = 4.5V$ )

100% UIS Tested  
 100% Rg Tested



SOIC-8

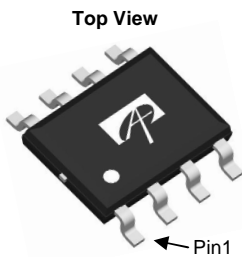

Bottom View

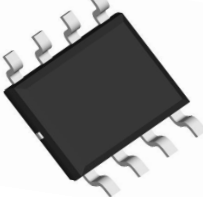

Top View

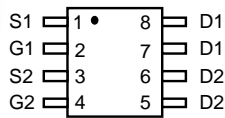

SRFET™

Soft Recovery MOSFET:  
 Integrated Schottky Diode

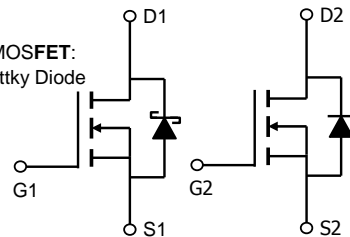

### Absolute Maximum Ratings $T_A=25^\circ C$ unless otherwise noted

Parameter	Symbol	Max FET1	Max FET2	Units
Drain-Source Voltage	$V_{DS}$	30	30	V
Gate-Source Voltage	$V_{GS}$	$\pm 12$	$\pm 12$	V
Continuous Drain Current <sup>A</sup>	$I_{DSM}$	$T_A=25^\circ C$	9.0	A
		$T_A=70^\circ C$	7.2	
Pulsed Drain Current <sup>B</sup>	$I_{DM}$	40	40	
Avalanche Current <sup>B</sup>	$I_{AR}$	16	12	A
Repetitive avalanche energy $L=0.3mH$ <sup>B</sup>	$E_{AR}$	38	22	mJ
Power Dissipation	$P_{DSM}$	$T_A=25^\circ C$	2.0	W
		$T_A=70^\circ C$	1.3	
Junction and Storage Temperature Range	$T_J, T_{STG}$	-55 to 150	-55 to 150	$^\circ C$

### Thermal Characteristics FET1

Parameter	Symbol	Typ	Max	Units
Maximum Junction-to-Ambient <sup>A</sup>	$R_{\theta JA}$	48	62.5	$^\circ C/W$
$t \leq 10s$				
Maximum Junction-to-Ambient <sup>A</sup>	$R_{\theta JL}$	32	40	$^\circ C/W$
Steady-State				
Maximum Junction-to-Lead <sup>C</sup>				

### Thermal Characteristics FET2

Parameter	Symbol	Typ	Max	Units
Maximum Junction-to-Ambient <sup>A</sup>	$R_{\theta JA}$	48	62.5	$^\circ C/W$
$t \leq 10s$				
Maximum Junction-to-Ambient <sup>A</sup>	$R_{\theta JL}$	32	40	$^\circ C/W$
Steady-State				
Maximum Junction-to-Lead <sup>C</sup>				

FET1 Electrical Characteristics ( $T_J=25^\circ\text{C}$  unless otherwise noted)

Symbol	Parameter	Conditions	Min	Typ	Max	Units
<b>STATIC PARAMETERS</b>						
$BV_{DSS}$	Drain-Source Breakdown Voltage	$I_D=1\text{mA}, V_{GS}=0\text{V}$	30			V
$I_{DSS}$	Zero Gate Voltage Drain Current	$V_{DS}=24\text{V}, V_{GS}=0\text{V}$ $T_J=125^\circ\text{C}$		0.01 5	0.1 10	mA
$I_{GSS}$	Gate-Body leakage current	$V_{DS}=0\text{V}, V_{GS}=\pm 12\text{V}$			0.1	$\mu\text{A}$
$V_{GS(th)}$	Gate Threshold Voltage	$V_{DS}=V_{GS}, I_D=250\mu\text{A}$	1.5	1.85	2.4	V
$I_{D(ON)}$	On state drain current	$V_{GS}=4.5\text{V}, V_{DS}=5\text{V}$	40			A
$R_{DS(ON)}$	Static Drain-Source On-Resistance	$V_{GS}=10\text{V}, I_D=9\text{A}$ $T_J=125^\circ\text{C}$		13 20.0	15.8 25.0	$\text{m}\Omega$
		$V_{GS}=4.5\text{V}, I_D=7\text{A}$		15.7	19.5	$\text{m}\Omega$
$g_{FS}$	Forward Transconductance	$V_{DS}=5\text{V}, I_D=9\text{A}$		64		S
$V_{SD}$	Diode Forward Voltage	$I_S=1\text{A}, V_{GS}=0\text{V}$		0.4	0.6	V
$I_S$	Maximum Body-Diode + Schottky Continuous Current				4.5	A
<b>DYNAMIC PARAMETERS</b>						
$C_{iss}$	Input Capacitance	$V_{GS}=0\text{V}, V_{DS}=15\text{V}, f=1\text{MHz}$		1450	1885	pF
$C_{oss}$	Output Capacitance			224		pF
$C_{rss}$	Reverse Transfer Capacitance			92		pF
$R_g$	Gate resistance	$V_{GS}=0\text{V}, V_{DS}=0\text{V}, f=1\text{MHz}$		1.6	3	$\Omega$
<b>SWITCHING PARAMETERS</b>						
$Q_g(10\text{V})$	Total Gate Charge	$V_{GS}=10\text{V}, V_{DS}=15\text{V}, I_D=9\text{A}$		24.0	31	
$Q_g(4.5\text{V})$	Total Gate Charge			12.0		nC
$Q_{gs}$	Gate Source Charge			3.9		nC
$Q_{gd}$	Gate Drain Charge			4.2		nC
$t_{D(on)}$	Turn-On DelayTime	$V_{GS}=10\text{V}, V_{DS}=15\text{V}, R_L=1.7\Omega,$ $R_{GEN}=3\Omega$		5.5		ns
$t_r$	Turn-On Rise Time			4.7		ns
$t_{D(off)}$	Turn-Off DelayTime			24.0		ns
$t_f$	Turn-Off Fall Time			4.0		ns
$t_{rr}$	Body Diode Reverse Recovery Time	$I_F=9\text{A}, di/dt=300\text{A}/\mu\text{s}$		10	13	ns
$Q_{rr}$	Body Diode Reverse Recovery Charge	$I_F=9\text{A}, di/dt=300\text{A}/\mu\text{s}$		6.8		nC

A: The value of  $R_{\theta JA}$  is measured with the device in a still air environment with  $T_A=25^\circ\text{C}$ . The power dissipation  $P_{DSM}$  and current rating  $I_{DSM}$  are based on  $T_{J(MAX)}=150^\circ\text{C}$ , using  $t \leq 10\text{s}$  junction-to-ambient thermal resistance.

B: Repetitive rating, pulse width limited by junction temperature  $T_{J(MAX)}=150^\circ\text{C}$ .

C: The  $R_{\theta JA}$  is the sum of the thermal impedance from junction to lead  $R_{\theta JL}$  and lead to ambient.

D: The static characteristics in Figures 1 to 6 are obtained using  $<300\mu\text{s}$  pulses, duty cycle 0.5% max.

E: These tests are performed with the device mounted on 1 in 2 FR-4 board with 2oz. Copper, in a still air environment with  $T_A=25^\circ\text{C}$ . The SOA curve provides a single pulse rating.

Rev2: May 2011

THIS PRODUCT HAS BEEN DESIGNED AND QUALIFIED FOR THE CONSUMER MARKET. APPLICATIONS OR USES AS CRITICAL COMPONENTS IN LIFE SUPPORT DEVICES OR SYSTEMS ARE NOT AUTHORIZED. AOS DOES NOT ASSUME ANY LIABILITY ARISING OUT OF SUCH APPLICATIONS OR USES OF ITS PRODUCTS. AOS RESERVES THE RIGHT TO IMPROVE PRODUCT DESIGN, FUNCTIONS AND RELIABILITY WITHOUT NOTICE.

FET1 TYPICAL ELECTRICAL AND THERMAL CHARACTERISTICS

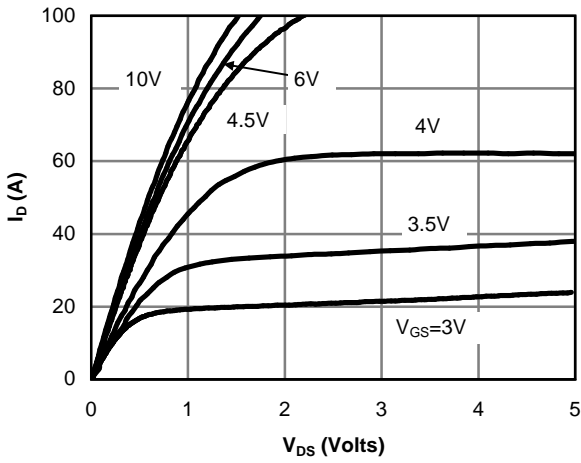

Figure 1: On-Region Characteristics

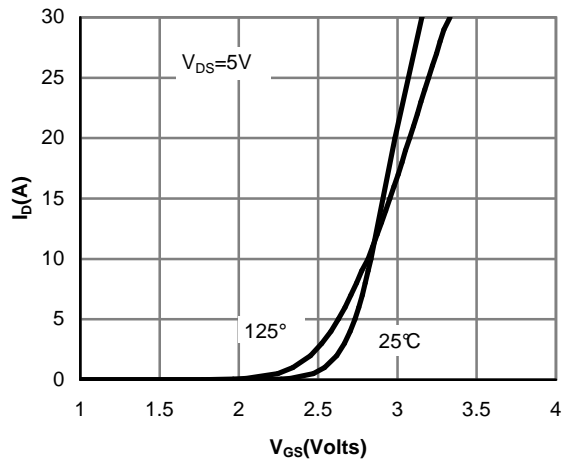

Figure 2: Transfer Characteristics

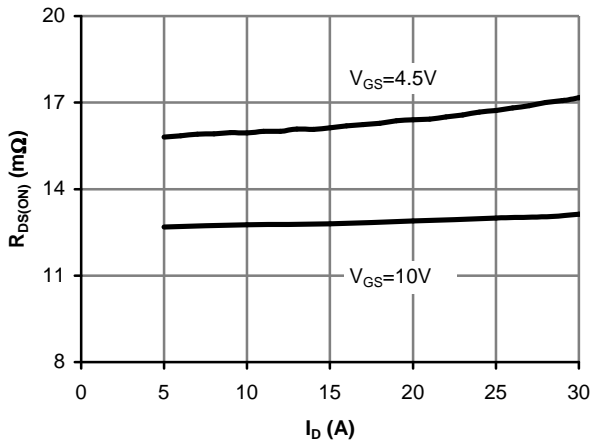

Figure 3: On-Resistance vs. Drain Current and Gate Voltage

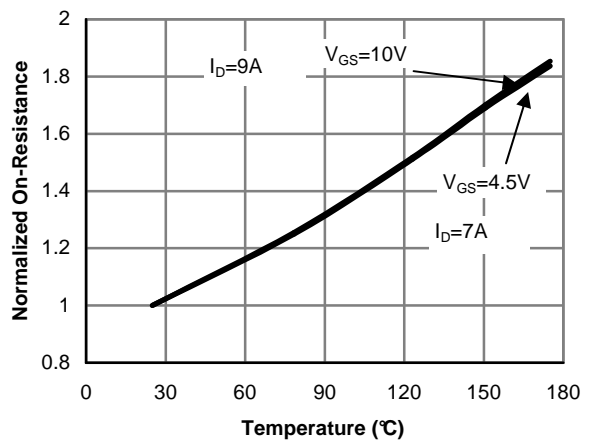

Figure 4: On-Resistance vs. Junction Temperature

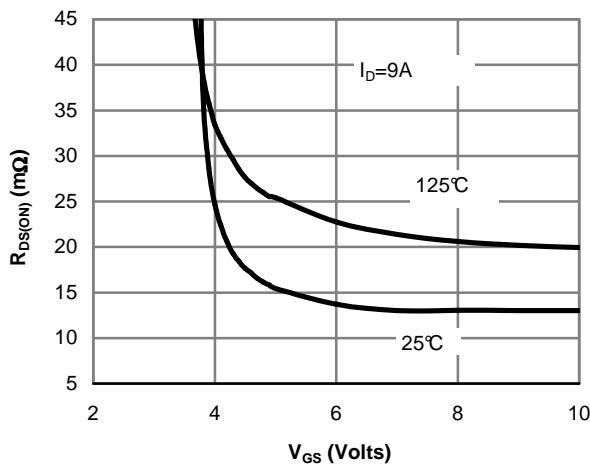

Figure 5: On-Resistance vs. Gate-Source Voltage

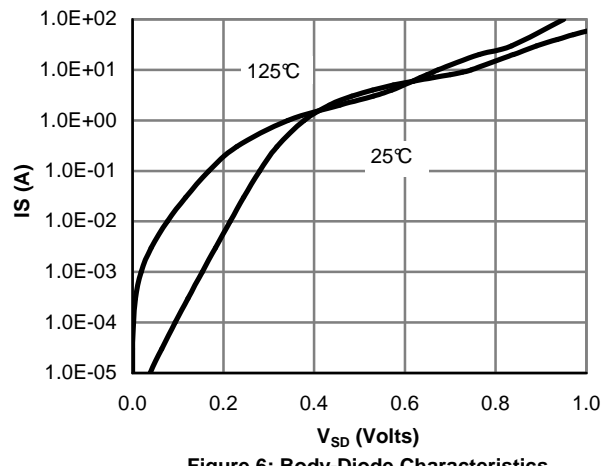

Figure 6: Body-Diode Characteristics

FET1 TYPICAL ELECTRICAL AND THERMAL CHARACTERISTICS

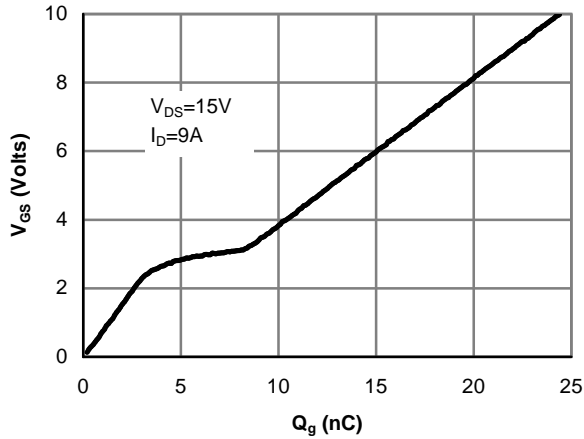

Figure 7: Gate-Charge Characteristics

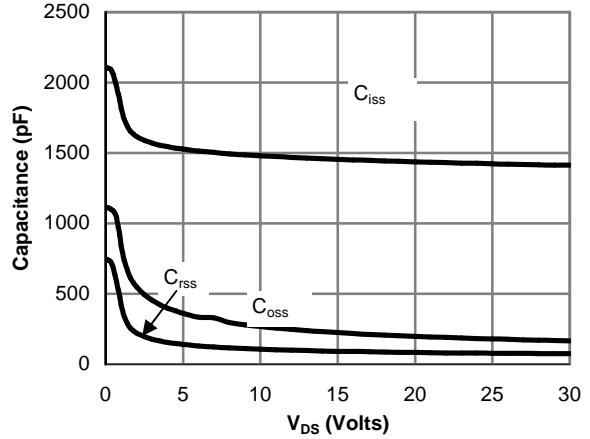

Figure 8: Capacitance Characteristics

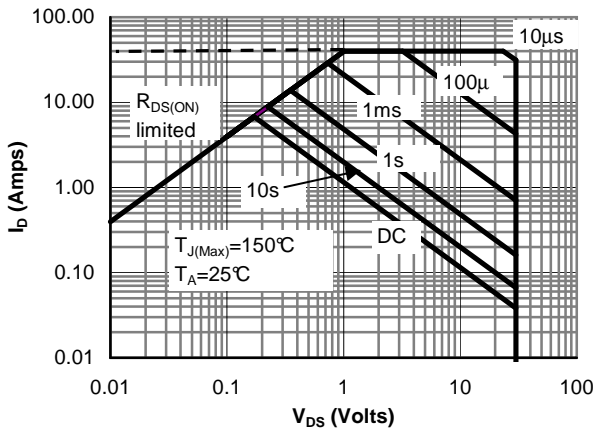

Figure 9: Maximum Forward Biased Safe Operating Area (Note E)

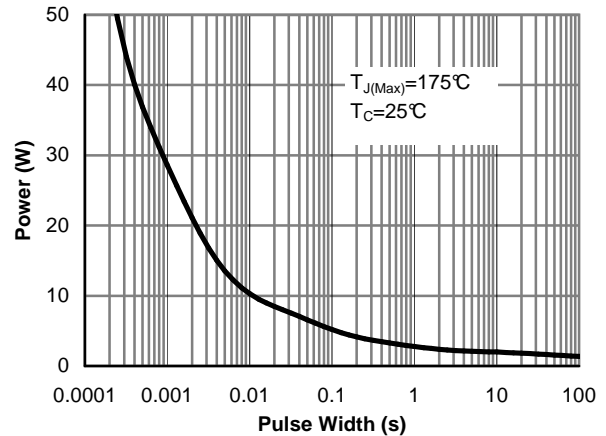

Figure 10: Single Pulse Power Rating Junction-to-Ambient (Note E)

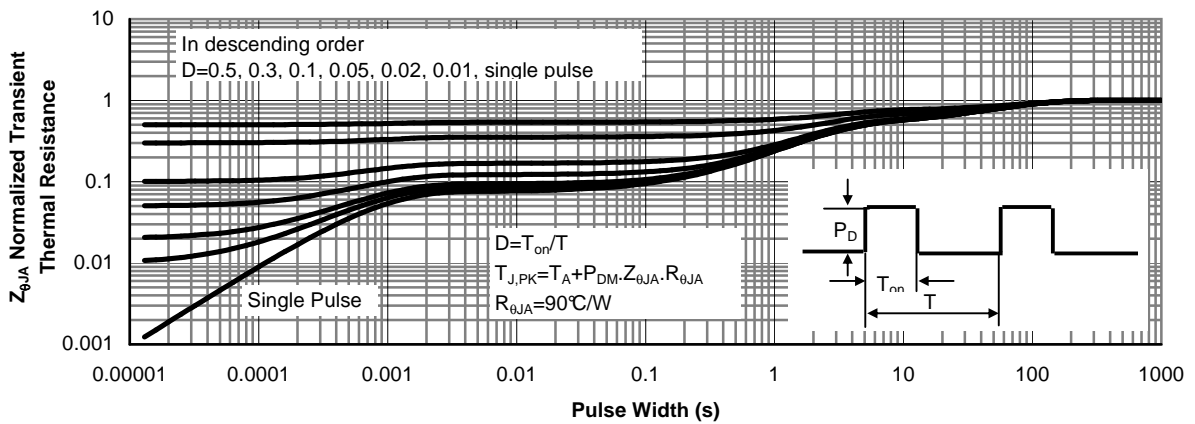

Figure 11: Normalized Maximum Transient Thermal Impedance (Note E)

FET1 TYPICAL ELECTRICAL AND THERMAL CHARACTERISTICS

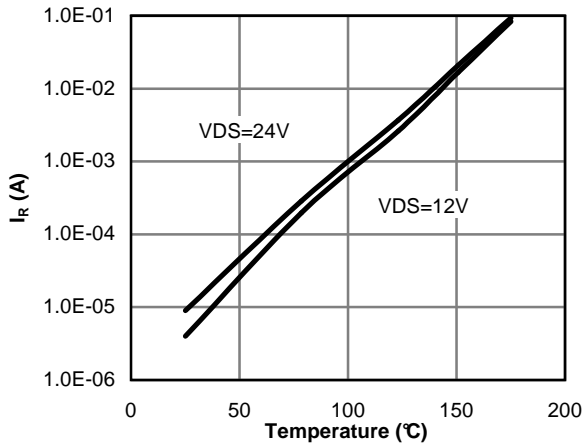

Figure 12: Diode Reverse Leakage Current vs. Junction Temperature

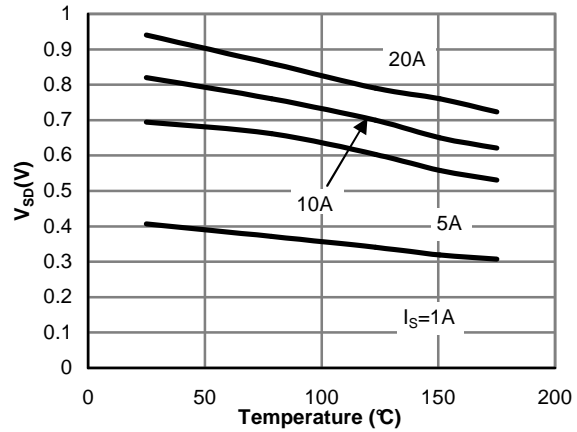

Figure 13: Diode Forward voltage vs. Junction Temperature

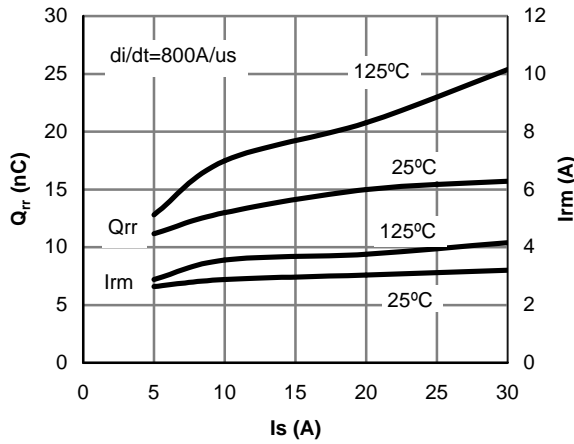

Figure 14: Diode Reverse Recovery Charge and Peak Current vs. Conduction Current

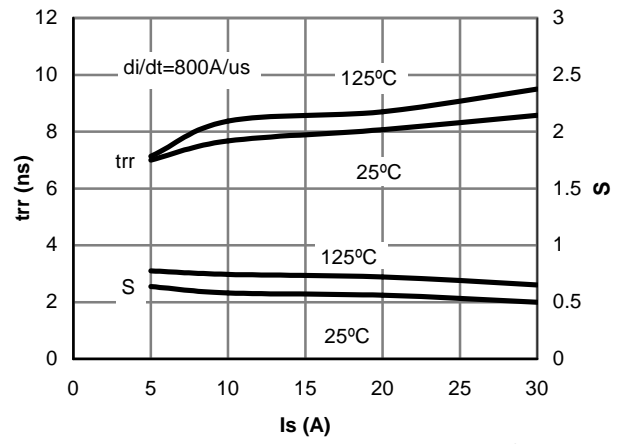

Figure 15: Diode Reverse Recovery Time and Soft Coefficient vs. Conduction Current

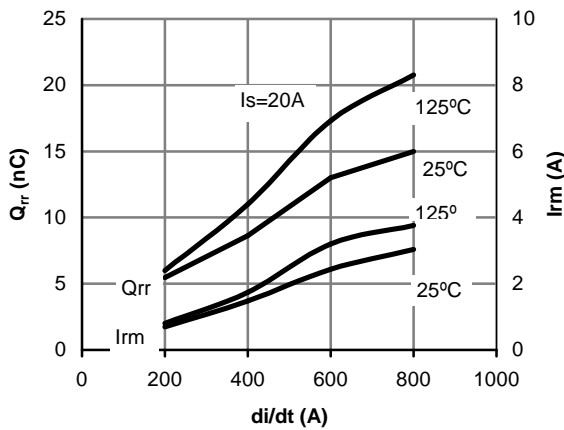

Figure 16: Diode Reverse Recovery Charge and Peak Current vs. di/dt

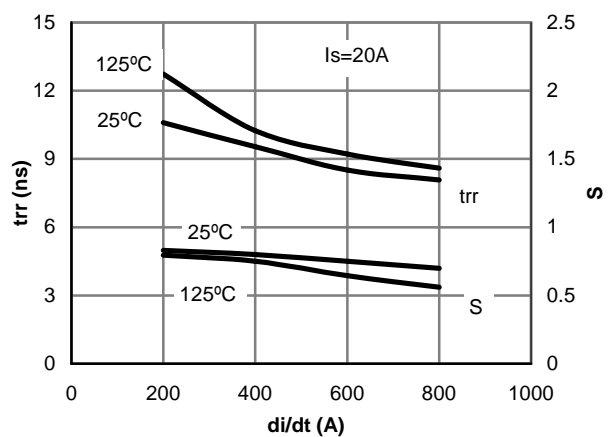

Figure 17: Diode Reverse Recovery Time and Soft Coefficient vs. di/dt

FET2 Electrical Characteristics ( $T_J=25^\circ\text{C}$  unless otherwise noted)

Symbol	Parameter	Conditions	Min	Typ	Max	Units
<b>STATIC PARAMETERS</b>						
$BV_{DSS}$	Drain-Source Breakdown Voltage	$I_D=250\mu\text{A}$ , $V_{GS}=0\text{V}$	30			V
$I_{DSS}$	Zero Gate Voltage Drain Current	$V_{DS}=24\text{V}$ , $V_{GS}=0\text{V}$ $T_J=55^\circ\text{C}$			1 5	$\mu\text{A}$
$I_{GSS}$	Gate-Body leakage current	$V_{DS}=0\text{V}$ , $V_{GS}=\pm 12\text{V}$			100	nA
$V_{GS(th)}$	Gate Threshold Voltage	$V_{DS}=V_{GS}$ , $I_D=250\mu\text{A}$	0.7	1	1.5	V
$I_{D(ON)}$	On state drain current	$V_{GS}=4.5\text{V}$ , $V_{DS}=5\text{V}$	40			A
$R_{DS(ON)}$	Static Drain-Source On-Resistance	$V_{GS}=10\text{V}$ , $I_D=7.3\text{A}$ $T_J=125^\circ\text{C}$		20 28	24 34	$\text{m}\Omega$
		$V_{GS}=4.5\text{V}$ , $I_D=6\text{A}$		23.5	29	$\text{m}\Omega$
$g_{FS}$	Forward Transconductance	$V_{DS}=5\text{V}$ , $I_D=7.3\text{A}$		26		S
$V_{SD}$	Diode Forward Voltage	$I_S=1\text{A}$ , $V_{GS}=0\text{V}$		0.71	1	V
$I_S$	Maximum Body-Diode Continuous Current				4.5	A
<b>DYNAMIC PARAMETERS</b>						
$C_{iss}$	Input Capacitance	$V_{GS}=0\text{V}$ , $V_{DS}=15\text{V}$ , $f=1\text{MHz}$		900	1100	pF
$C_{oss}$	Output Capacitance			88		pF
$C_{rss}$	Reverse Transfer Capacitance			65		pF
$R_g$	Gate resistance	$V_{GS}=0\text{V}$ , $V_{DS}=0\text{V}$ , $f=1\text{MHz}$		0.95	1.5	$\Omega$
<b>SWITCHING PARAMETERS</b>						
$Q_g$	Total Gate Charge	$V_{GS}=4.5\text{V}$ , $V_{DS}=15\text{V}$ , $I_D=7.3\text{A}$		10	12	nC
$Q_{gs}$	Gate Source Charge			1.8		nC
$Q_{gd}$	Gate Drain Charge			3.75		nC
$t_{D(on)}$	Turn-On DelayTime	$V_{GS}=10\text{V}$ , $V_{DS}=15\text{V}$ , $R_L=2\Omega$ , $R_{GEN}=6\Omega$		3.2		ns
$t_r$	Turn-On Rise Time			3.5		ns
$t_{D(off)}$	Turn-Off DelayTime			21.5		ns
$t_f$	Turn-Off Fall Time			2.7		ns
$t_{rr}$	Body Diode Reverse Recovery Time		$I_F=7.3\text{A}$ , $dI/dt=100\text{A}/\mu\text{s}$		16.8	20
$Q_{rr}$	Body Diode Reverse Recovery Charge	$I_F=7.3\text{A}$ , $dI/dt=100\text{A}/\mu\text{s}$		8	12	nC

A: The value of  $R_{\theta JA}$  is measured with the device mounted on 1in<sup>2</sup> FR-4 board with 2oz. Copper, in a still air environment with  $T_A=25^\circ\text{C}$ . The value in any given application depends on the user's specific board design. The current rating is based on the  $t \leq 10\text{s}$  thermal resistance rating.

B: Repetitive rating, pulse width limited by junction temperature.

C: The  $R_{\theta JA}$  is the sum of the thermal impedance from junction to lead  $R_{\theta JL}$  and lead to ambient.

D: The static characteristics in Figures 1 to 6 are obtained using  $<300\mu\text{s}$  pulses, duty cycle 0.5% max.

E: These tests are performed with the device mounted on 1 in<sup>2</sup> FR-4 board with 2oz. Copper, in a still air environment with  $T_A=25^\circ\text{C}$ . The SOA curve provides a single pulse rating.

Rev2: May 2011

THIS PRODUCT HAS BEEN DESIGNED AND QUALIFIED FOR THE CONSUMER MARKET. APPLICATIONS OR USES AS CRITICAL COMPONENTS IN LIFE SUPPORT DEVICES OR SYSTEMS ARE NOT AUTHORIZED. AOS DOES NOT ASSUME ANY LIABILITY ARISING OUT OF SUCH APPLICATIONS OR USES OF ITS PRODUCTS. AOS RESERVES THE RIGHT TO IMPROVE PRODUCT DESIGN, FUNCTIONS AND RELIABILITY WITHOUT NOTICE.

FET2 TYPICAL ELECTRICAL AND THERMAL CHARACTERISTICS

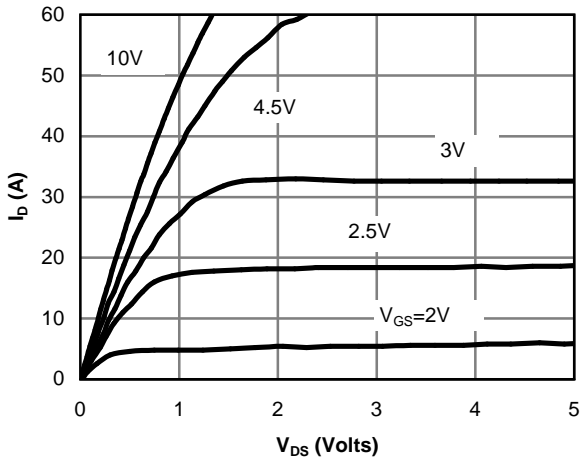

Fig 1: On-Region Characteristics

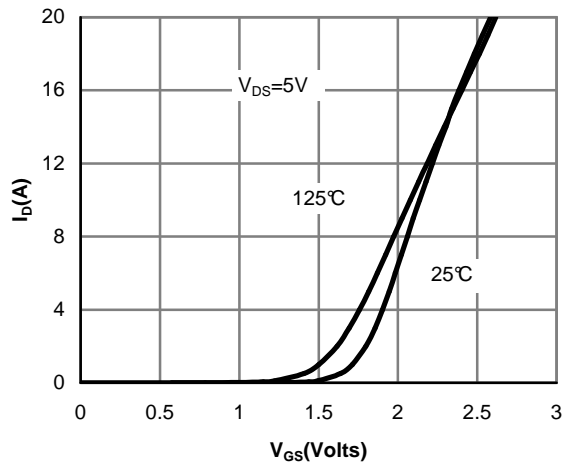

Figure 2: Transfer Characteristics

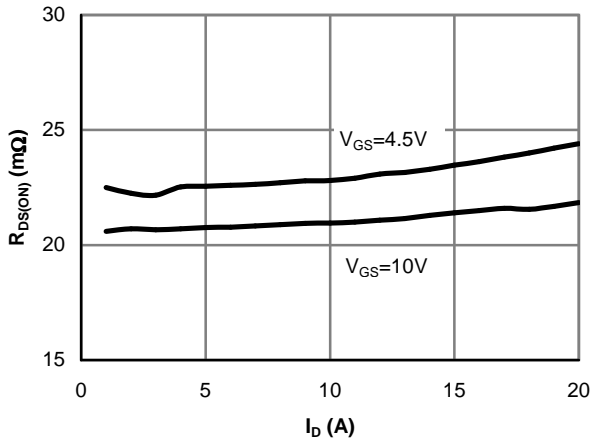

Figure 3: On-Resistance vs. Drain Current and Gate Voltage

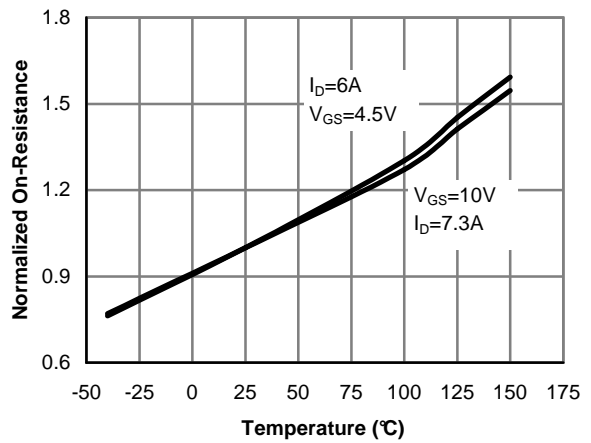

Figure 4: On-Resistance vs. Junction Temperature

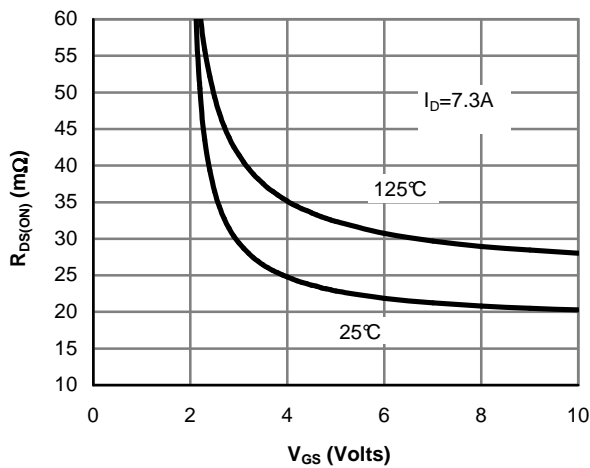

Figure 5: On-Resistance vs. Gate-Source Voltage

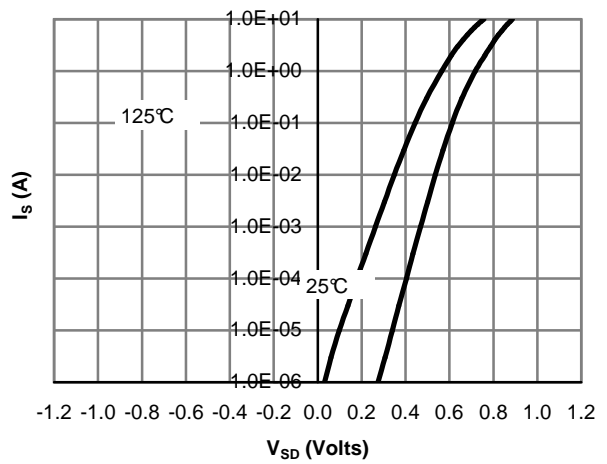

Figure 6: Body-Diode Characteristics

FET2 TYPICAL ELECTRICAL AND THERMAL CHARACTERISTICS

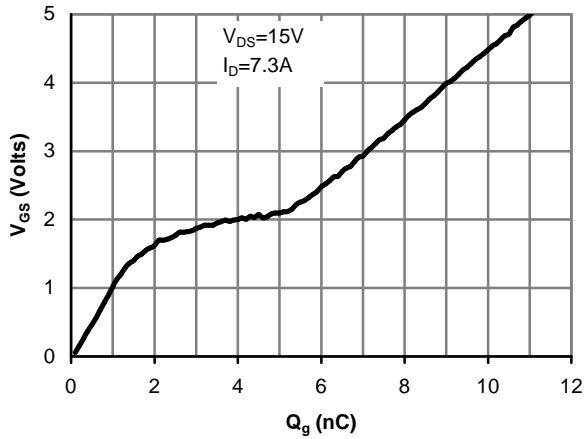

Figure 7: Gate-Charge Characteristics

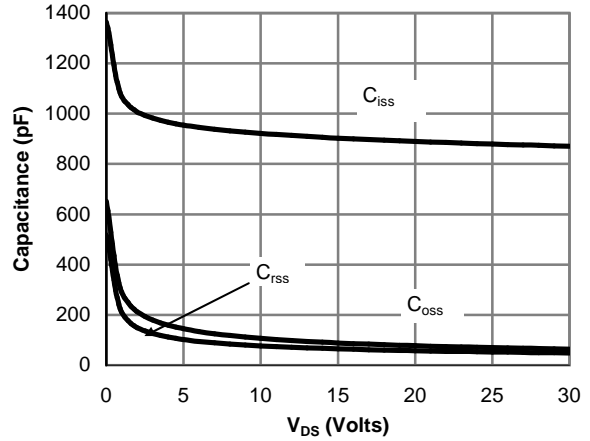

Figure 8: Capacitance Characteristics

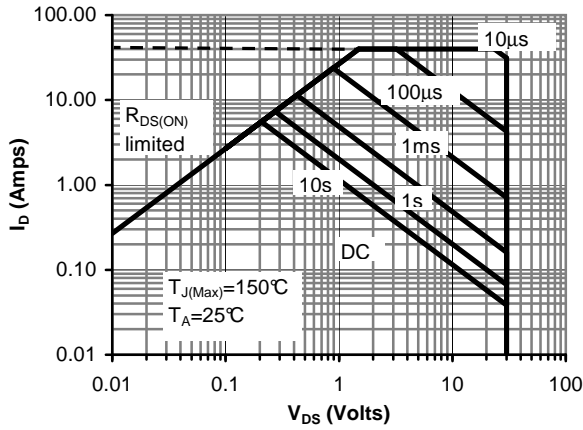

Figure 9: Maximum Forward Biased Safe Operating Area (Note E)

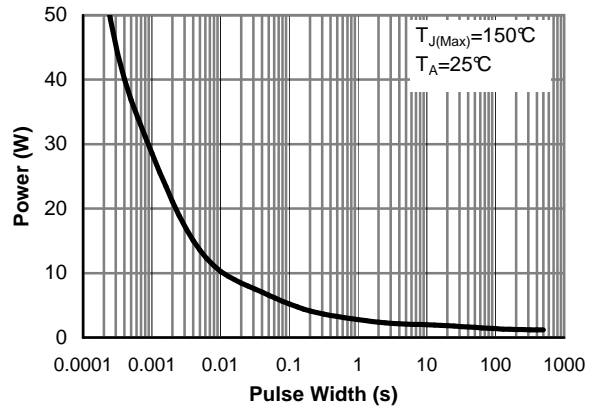

Figure 10: Single Pulse Power Rating Junction-to-Ambient (Note E)

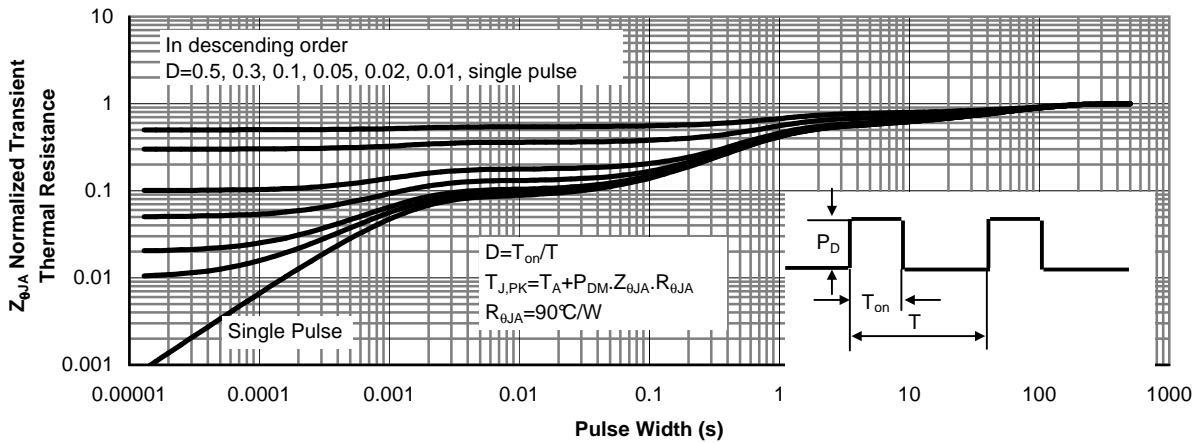
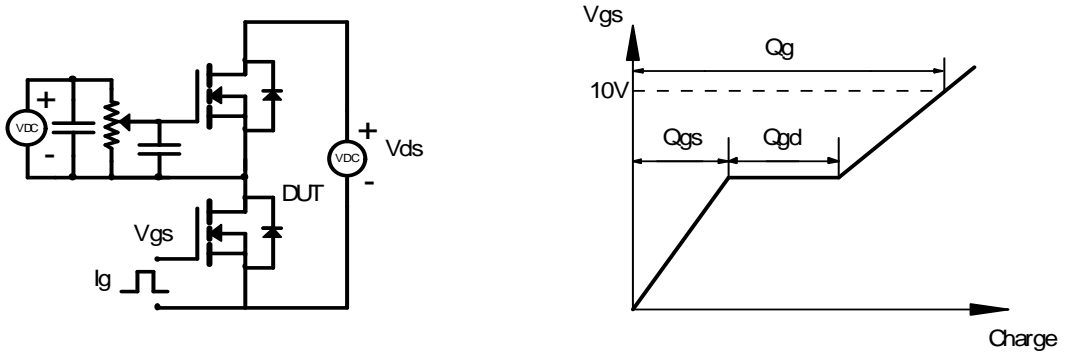

Figure 11: Normalized Maximum Transient Thermal Impedance



Gate Charge Test Circuit & Waveform



Resistive Switching Test Circuit & Waveforms

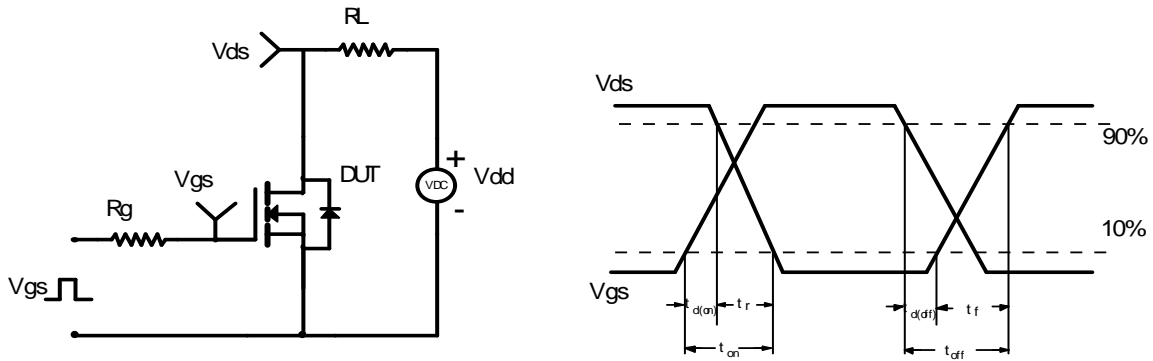

Unclamped Inductive Switching (UIS) Test Circuit & Waveforms

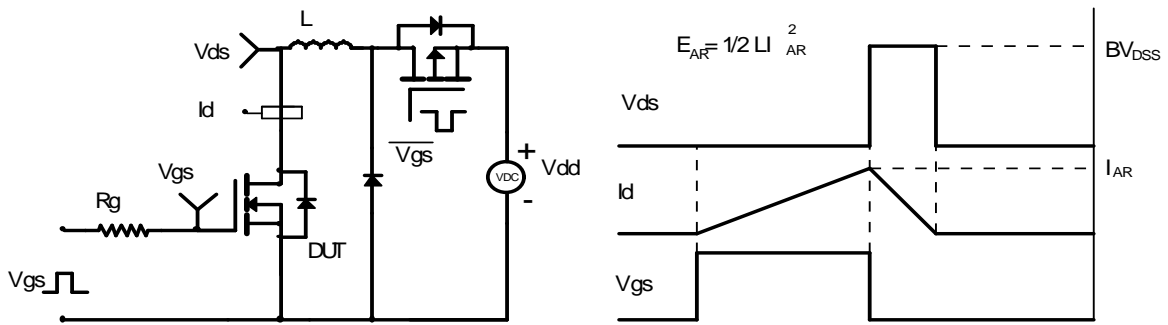

Diode Recovery Test Circuit & Waveforms

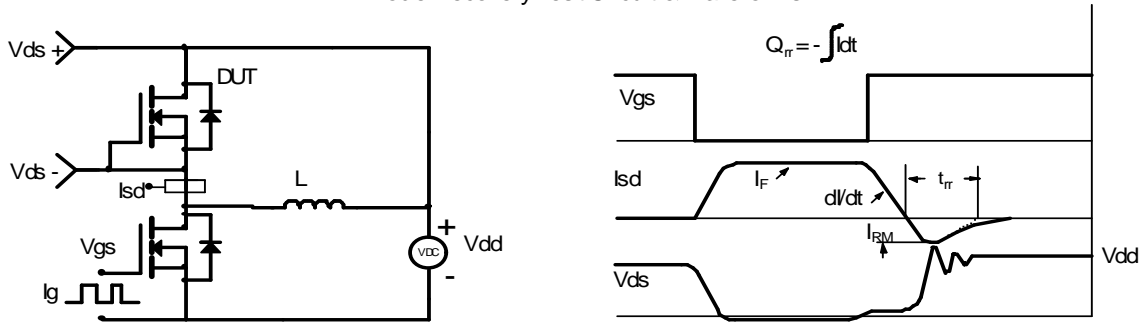

单击下面可查看定价，库存，交付和生命周期等信息

[>>AOS\(万国半导体\)](#)