

**General Description**

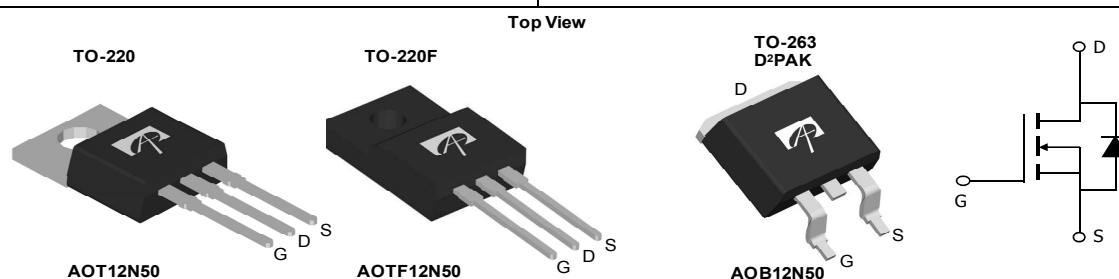
The AOT12N50 & AOB12N50 & AOTF12N50 have been fabricated using an advanced high voltage MOSFET process that is designed to deliver high levels of performance and robustness in popular AC-DC applications. By providing low  $R_{DS(on)}$ ,  $C_{iss}$  and  $C_{rss}$  along with guaranteed avalanche capability these parts can be adopted quickly into new and existing offline power supply designs.

For Halogen Free add "L" suffix to part number:  
 AOT12N50L & AOTF12N50L & AOB12N50L

**Product Summary**

$V_{DS}$	600V@150°C
$I_D$ (at $V_{GS}=10V$ )	12A
$R_{DS(ON)}$ (at $V_{GS}=10V$ )	< 0.52Ω

100% UIS Tested  
 100%  $R_g$  Tested


**Absolute Maximum Ratings  $T_A=25^\circ C$  unless otherwise noted**

Parameter	Symbol	AOT12N50/AOB12N50	AOTF12N50	Units
Drain-Source Voltage	$V_{DS}$	500		V
Gate-Source Voltage	$V_{GS}$	±30		V
Continuous Drain Current	$I_D$	$T_C=25^\circ C$	12	12*
		$T_C=100^\circ C$	8.4	8.4*
Pulsed Drain Current <sup>C</sup>	$I_{DM}$	48		A
Avalanche Current <sup>C</sup>	$I_{AR}$	5.5		A
Repetitive avalanche energy <sup>C</sup>	$E_{AR}$	454		mJ
Single pulsed avalanche energy <sup>G</sup>	$E_{AS}$	908		mJ
MOSFET dv/dt ruggedness	dv/dt	40		V/ns
Peak diode recovery dv/dt		5		
Power Dissipation <sup>B</sup>	$P_D$	$T_C=25^\circ C$	250	50
		Derate above 25°C	2	0.4
Junction and Storage Temperature Range	$T_J, T_{STG}$	-55 to 150		°C
Maximum lead temperature for soldering purpose, 1/8" from case for 5 seconds	$T_L$	300		°C

**Thermal Characteristics**

Parameter	Symbol	AOT12N50/AOB12N50	AOTF12N50	Units
Maximum Junction-to-Ambient <sup>A,D</sup>	$R_{\theta JA}$	65	65	°C/W
Maximum Case-to-sink <sup>A</sup>	$R_{\theta CS}$	0.5	--	°C/W
Maximum Junction-to-Case	$R_{\theta JC}$	0.5	2.5	°C/W

\* Drain current limited by maximum junction temperature.

**Electrical Characteristics (T<sub>J</sub>=25°C unless otherwise noted)**

Symbol	Parameter	Conditions	Min	Typ	Max	Units
<b>STATIC PARAMETERS</b>						
BV <sub>DSS</sub>	Drain-Source Breakdown Voltage	I <sub>D</sub> =250μA, V <sub>GS</sub> =0V, T <sub>J</sub> =25°C	500			V
		I <sub>D</sub> =250μA, V <sub>GS</sub> =0V, T <sub>J</sub> =150°C		600		
BV <sub>DSS</sub> /ΔT <sub>J</sub>	Breakdown Voltage Temperature Coefficient	I <sub>D</sub> =250μA, V <sub>GS</sub> =0V		0.54		V/°C
I <sub>DSS</sub>	Zero Gate Voltage Drain Current	V <sub>DS</sub> =500V, V <sub>GS</sub> =0V			1	μA
		V <sub>DS</sub> =400V, T <sub>J</sub> =125°C			10	
I <sub>GSS</sub>	Gate-Body leakage current	V <sub>DS</sub> =0V, V <sub>GS</sub> =±30V			±100	nA
V <sub>GS(th)</sub>	Gate Threshold Voltage	V <sub>DS</sub> =5V, I <sub>D</sub> =250μA	3.3	3.9	4.5	V
R <sub>DS(ON)</sub>	Static Drain-Source On-Resistance	V <sub>GS</sub> =10V, I <sub>D</sub> =6A		0.36	0.52	Ω
g <sub>FS</sub>	Forward Transconductance	V <sub>DS</sub> =40V, I <sub>D</sub> =6A		16		S
V <sub>SD</sub>	Diode Forward Voltage	I <sub>S</sub> =1A, V <sub>GS</sub> =0V		0.72	1	V
I <sub>S</sub>	Maximum Body-Diode Continuous Current				12	A
I <sub>SM</sub>	Maximum Body-Diode Pulsed Current				48	A
<b>DYNAMIC PARAMETERS</b>						
C <sub>iss</sub>	Input Capacitance	V <sub>GS</sub> =0V, V <sub>DS</sub> =25V, f=1MHz	1089	1361	1633	pF
C <sub>oss</sub>	Output Capacitance		134	167	200	pF
C <sub>rss</sub>	Reverse Transfer Capacitance		10	12.6	15	pF
R <sub>g</sub>	Gate resistance	V <sub>GS</sub> =0V, V <sub>DS</sub> =0V, f=1MHz	1.8	3.6	5.4	Ω
<b>SWITCHING PARAMETERS</b>						
Q <sub>g</sub>	Total Gate Charge	V <sub>GS</sub> =10V, V <sub>DS</sub> =400V, I <sub>D</sub> =12A		30.7	37	nC
Q <sub>gs</sub>	Gate Source Charge		7.6	9	nC	
Q <sub>gd</sub>	Gate Drain Charge		13.0	16	nC	
t <sub>D(on)</sub>	Turn-On DelayTime	V <sub>GS</sub> =10V, V <sub>DS</sub> =250V, I <sub>D</sub> =12A, R <sub>G</sub> =25Ω		29	35	ns
t <sub>r</sub>	Turn-On Rise Time		69	83	ns	
t <sub>D(off)</sub>	Turn-Off DelayTime		82	98	ns	
t <sub>f</sub>	Turn-Off Fall Time		55.5	67	ns	
t <sub>rr</sub>	Body Diode Reverse Recovery Time	I <sub>F</sub> =12A, dI/dt=100A/μs, V <sub>DS</sub> =100V		231	277	ns
Q <sub>rr</sub>	Body Diode Reverse Recovery Charge	I <sub>F</sub> =12A, dI/dt=100A/μs, V <sub>DS</sub> =100V		2.82	3.4	μC

A. The value of R<sub>θJA</sub> is measured with the device in a still air environment with T<sub>A</sub>=25°C.

B. The power dissipation P<sub>D</sub> is based on T<sub>J(MAX)</sub>=150°C, using junction-to-case thermal resistance, and is more useful in setting the upper dissipation limit for cases where additional heatsinking is used.

C. Repetitive rating, pulse width limited by junction temperature T<sub>J(MAX)</sub>=150°C. Ratings are based on low frequency and duty cycles to keep initial T<sub>J</sub>=25°C.

D. The R<sub>θJA</sub> is the sum of the thermal impedance from junction to case R<sub>θJC</sub> and case to ambient.

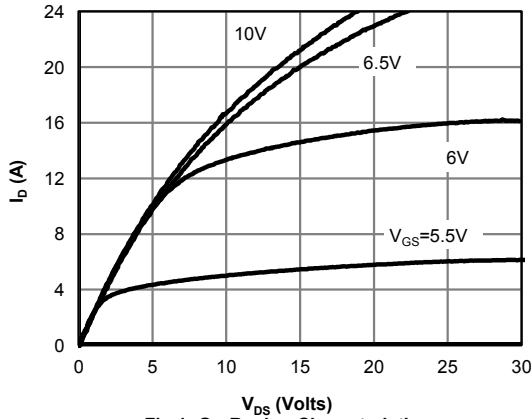
E. The static characteristics in Figures 1 to 6 are obtained using <300 μs pulses, duty cycle 0.5% max.

F. These curves are based on the junction-to-case thermal impedance which is measured with the device mounted to a large heatsink, assuming a maximum junction temperature of T<sub>J(MAX)</sub>=150°C. The SOA curve provides a single pulse rating.

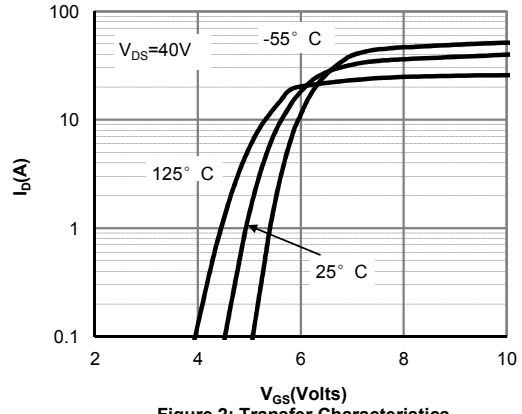
G. L=60mH, I<sub>AS</sub>=5.5A, V<sub>DD</sub>=150V, R<sub>G</sub>=25Ω, Starting T<sub>J</sub>=25°C

THIS PRODUCT HAS BEEN DESIGNED AND QUALIFIED FOR THE CONSUMER MARKET. APPLICATIONS OR USES AS CRITICAL COMPONENTS IN LIFE SUPPORT DEVICES OR SYSTEMS ARE NOT AUTHORIZED. AOS DOES NOT ASSUME ANY LIABILITY ARISING OUT OF SUCH APPLICATIONS OR USES OF ITS PRODUCTS. AOS RESERVES THE RIGHT TO IMPROVE PRODUCT DESIGN, FUNCTIONS AND RELIABILITY WITHOUT NOTICE.

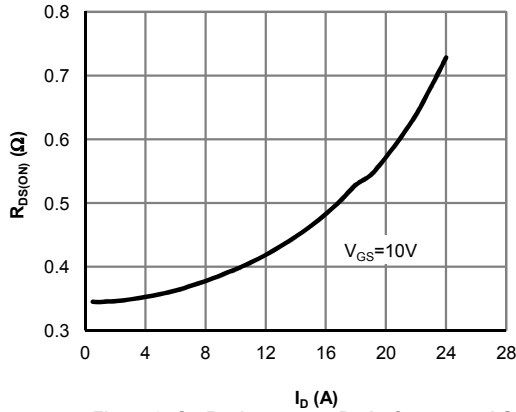
**TYPICAL ELECTRICAL AND THERMAL CHARACTERISTICS**



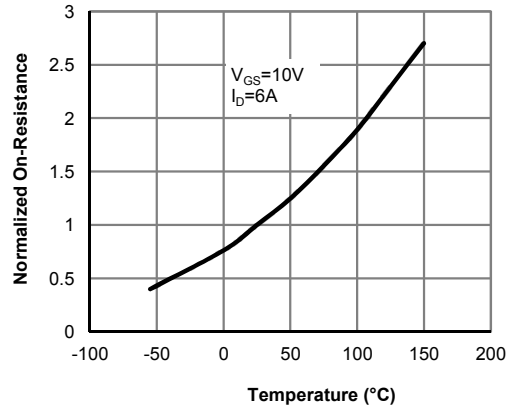
**Fig 1: On-Region Characteristics**



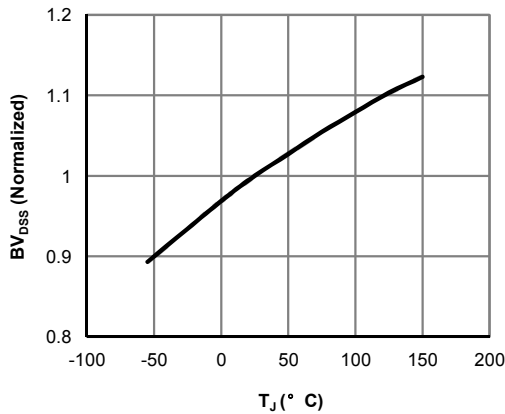
**Figure 2: Transfer Characteristics**



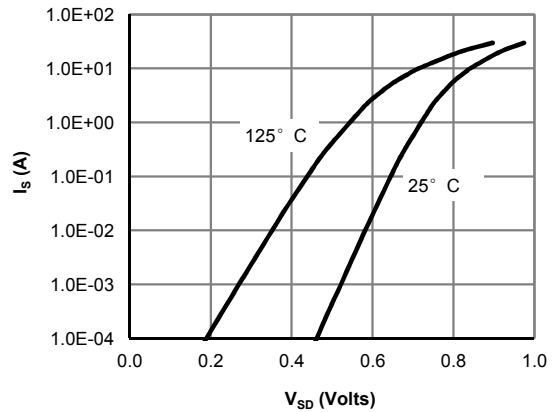
**Figure 3: On-Resistance vs. Drain Current and Gate Voltage**



**Figure 4: On-Resistance vs. Junction Temperature**

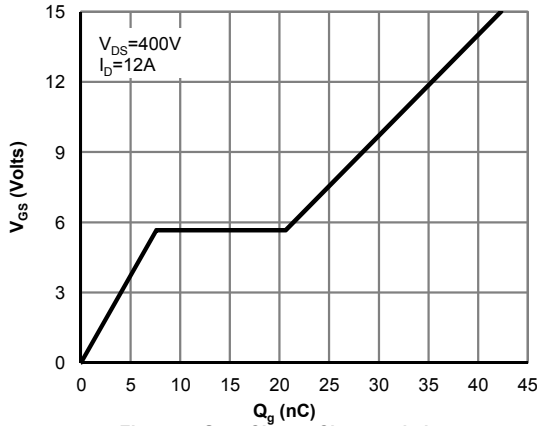


**Figure 5: Break Down vs. Junction Temperature**

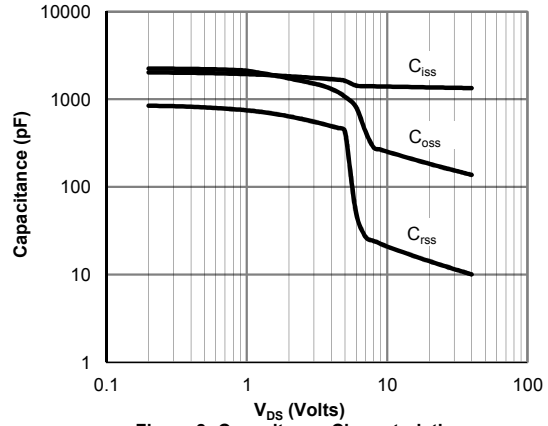


**Figure 6: Body-Diode Characteristics (Note E)**

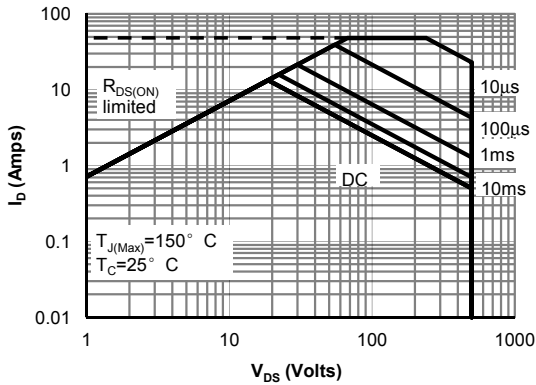
**TYPICAL ELECTRICAL AND THERMAL CHARACTERISTICS**



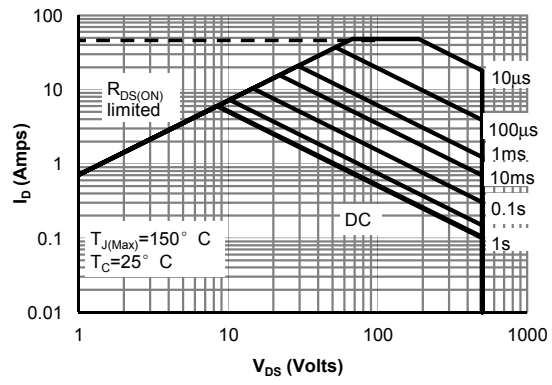
**Figure 7: Gate-Charge Characteristics**



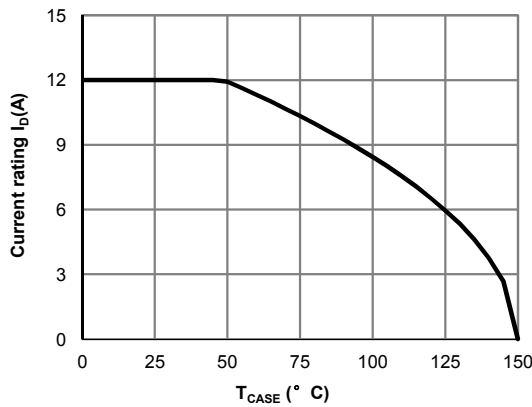
**Figure 8: Capacitance Characteristics**



**Figure 9: Maximum Forward Biased Safe Operating Area for AOT12N50/AOB12N50 (Note F)**



**Figure 10: Maximum Forward Biased Safe Operating Area for AOTF12N50 (Note F)**



**Figure 11: Current De-rating (Note B)**

**TYPICAL ELECTRICAL AND THERMAL CHARACTERISTICS**

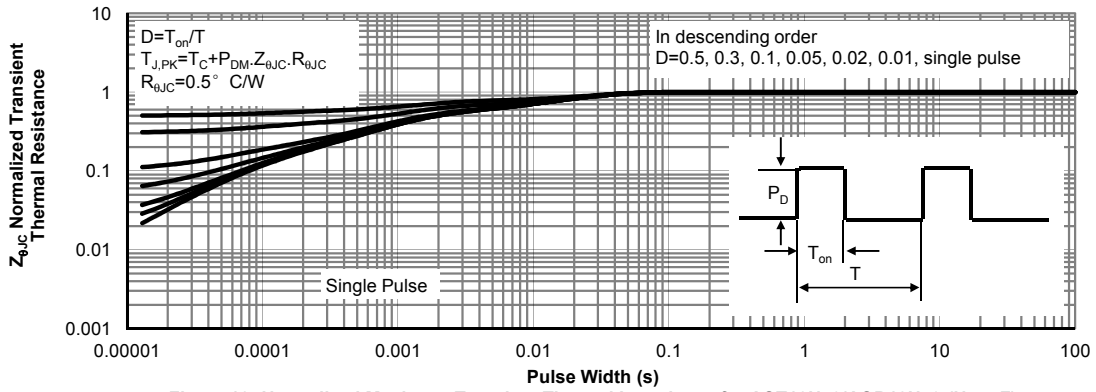


Figure 12: Normalized Maximum Transient Thermal Impedance for AOT12N50/AOB12N50 (Note F)

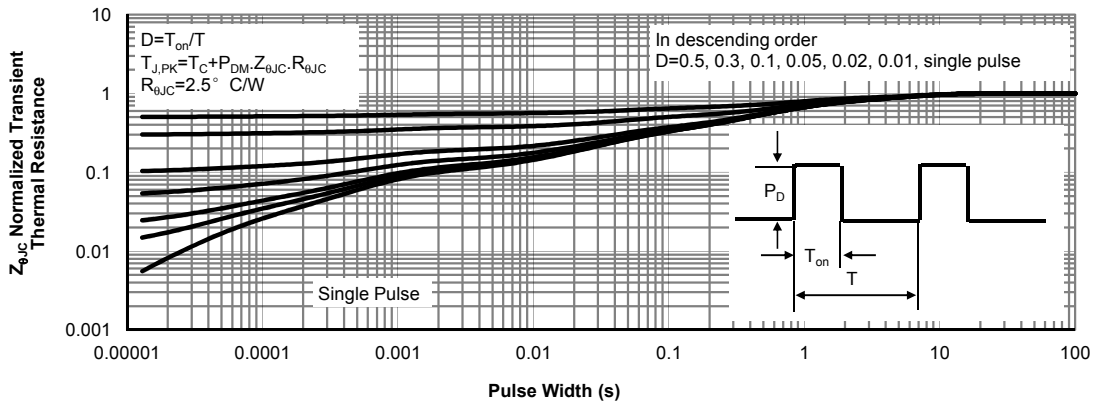
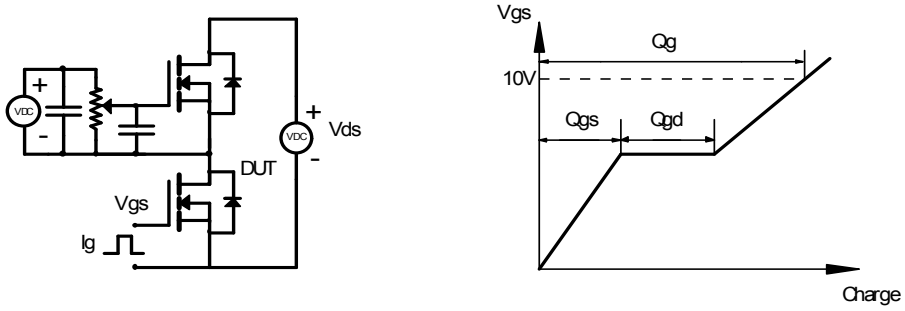
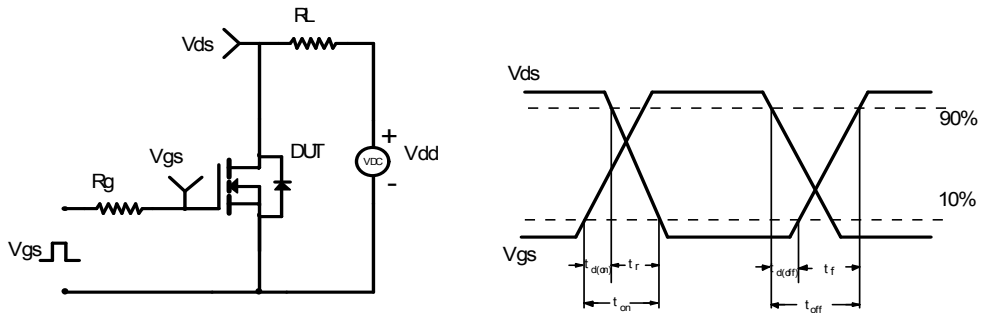


Figure 13: Normalized Maximum Transient Thermal Impedance for AOTF12N50 (Note F)

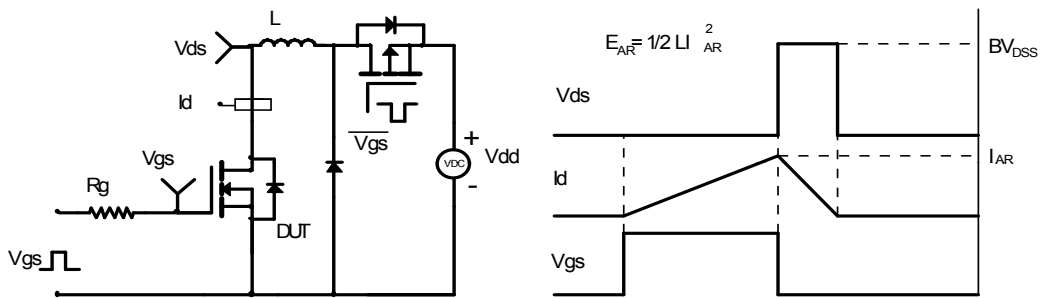
Gate Charge Test Circuit & Waveform



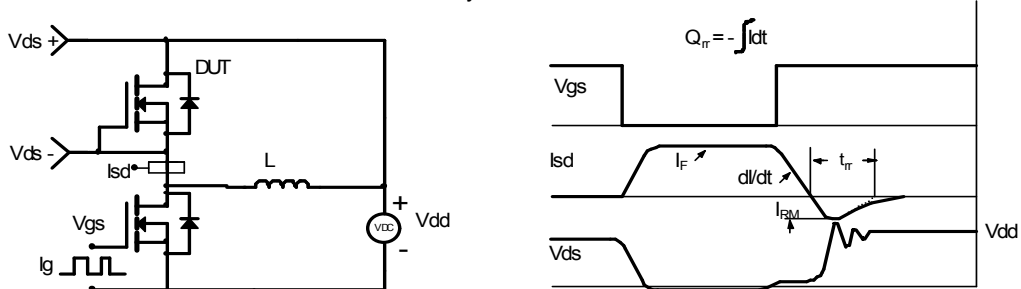
Resistive Switching Test Circuit & Waveforms



Unclamped Inductive Switching (UIS) Test Circuit & Waveforms



Diode Recovery Test Circuit & Waveforms



单击下面可查看定价，库存，交付和生命周期等信息

[>>AOS\(万代\)](#)