

General Description

- Trench Power MOSFET technology
- Low $R_{SS(ON)}$
- With ESD protection to improve battery performance and safety
- Common drain configuration for design simplicity
- RoHS and Halogen-Free Compliant

Applications

- Battery protection switch
- Mobile device battery charging and discharging

Product Summary

V_{SS}	12V
$R_{SS(ON)}$ (at $V_{GS}=4.5V$)	< 3.5m Ω
$R_{SS(ON)}$ (at $V_{GS}=4.0V$)	< 3.7m Ω
$R_{SS(ON)}$ (at $V_{GS}=3.8V$)	< 3.75m Ω
$R_{SS(ON)}$ (at $V_{GS}=3.1V$)	< 4.3m Ω
$R_{SS(ON)}$ (at $V_{GS}=2.5V$)	< 5m Ω

Typical ESD protection

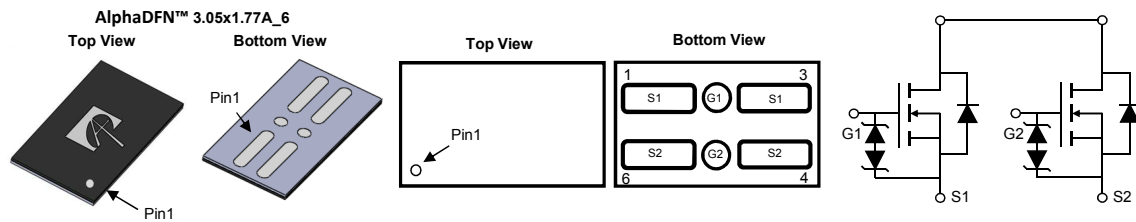
HBM Class 2

Orderable Part Number	Package Type	Form	Minimum Order Quantity
AOC3860A	AlphaDFN 3.05x1.77A_6	Tape & Reel	8000

Absolute Maximum Ratings $T_A=25^\circ\text{C}$ unless otherwise noted

Parameter	Symbol	Rating	Units
Source-Source Voltage	V_{SS}	12	V
Gate-Source Voltage	V_{GS}	± 8	V
Source Current(DC) ^{Note1}	I_S	25	A
Source Current(Pulse) ^{Note2}	I_{SM}	100	
Power Dissipation ^{Note1}	P_D	2.5	W
Junction and Storage Temperature Range	T_J, T_{STG}	-55 to 150	$^\circ\text{C}$

Thermal Characteristics

Parameter	Symbol	Typical	Units
Maximum Junction-to-Ambient $t \leq 10s$	$R_{\theta JA}$	40	$^\circ\text{C/W}$
Maximum Junction-to-Ambient Steady-State		50	$^\circ\text{C/W}$

Note 1. I_S rated value is based on bare silicon. Mounted on 70mmx70mm FR-4 board.

Note 2. PW < 10 μs pulses, duty cycle 1% max.

Electrical Characteristics (T_J=25°C unless otherwise noted)

Symbol	Parameter	Conditions	Min	Typ	Max	Units
STATIC PARAMETERS						
BV _{SSS}	Source-Source Breakdown Voltage	I _S =250μA, V _{GS} =0V Test Circuit 6	12			V
I _{SSS}	Zero Gate Voltage Source Current	V _{SS} =12V, V _{GS} =0V Test Circuit 1 T _J =55°C			1 5	μA
I _{GSS}	Gate leakage current	V _{SS} =0V, V _{GS} =±8V Test Circuit 2			±10	μA
V _{GS(th)}	Gate Threshold Voltage	V _{SS} =V _{GS} , I _S =250μA Test Circuit 3	0.3	0.6	1.0	V
R _{SS(ON)}	Static Source to Source On-Resistance	V _{GS} =4.5V, I _S =5A Test Circuit 4 T _J =125°C	2.0	2.8	3.5	mΩ
			2.7	3.85	4.8	
		V _{GS} =4.0V, I _S =5A Test Circuit 4	2.1	2.9	3.7	mΩ
		V _{GS} =3.8V, I _S =5A Test Circuit 4	2.2	2.95	3.75	mΩ
		V _{GS} =3.1V, I _S =5A Test Circuit 4	2.3	3.2	4.3	mΩ
	V _{GS} =2.5V, I _S =5A Test Circuit 4	2.5	3.6	5.0	mΩ	
g _{FS}	Forward Transconductance	V _{SS} =5V, I _S =5A Test Circuit 3		70		S
V _{FSS}	Forward Source to Source Voltage	I _S =1A, V _{GS} =0V Test Circuit 5		0.56	1	V
DYNAMIC PARAMETERS						
R _g	Gate resistance	f=1MHz		1.2		KΩ
SWITCHING PARAMETERS						
Q _g	Total Gate Charge	V _{G1S1} =4.5V, V _{SS} =6V, I _S =5A		44		nC
t _{D(on)}	Turn-On DelayTime	V _{G1S1} =4.5V, V _{SS} =6V, R _L =1.2Ω, R _{GEN} =3Ω Test Circuit8		2		μs
t _r	Turn-On Rise Time			4.5		μs
t _{D(off)}	Turn-Off DelayTime			6		μs
t _f	Turn-Off Fall Time			11		μs

APPLICATIONS OR USE AS CRITICAL COMPONENTS IN LIFE SUPPORT DEVICES OR SYSTEMS ARE NOT AUTHORIZED. AOS DOES NOT ASSUME ANY LIABILITY ARISING OUT OF SUCH APPLICATIONS OR USES OF ITS PRODUCTS. AOS RESERVES THE RIGHT TO IMPROVE PRODUCT DESIGN, FUNCTIONS AND RELIABILITY WITHOUT NOTICE.

TYPICAL ELECTRICAL AND THERMAL CHARACTERISTICS

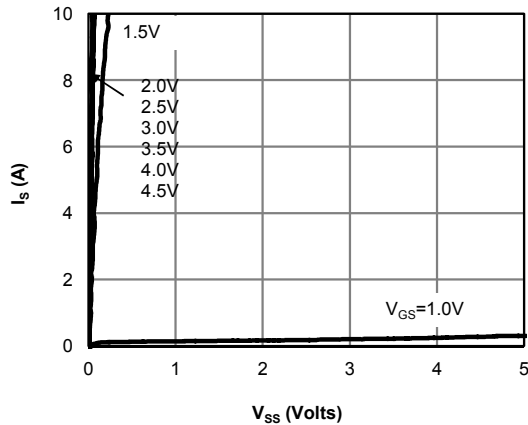

Figure 1: On-Region Characteristics

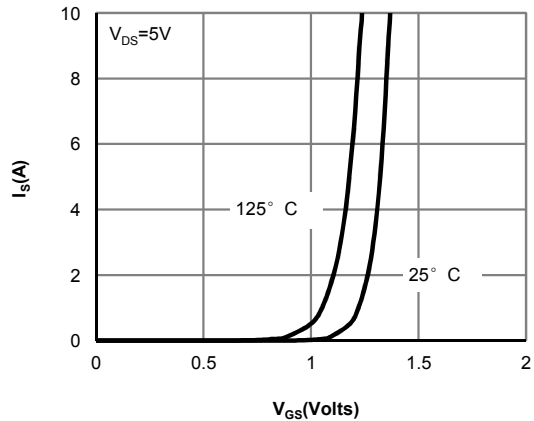

Figure 2: Transfer Characteristics

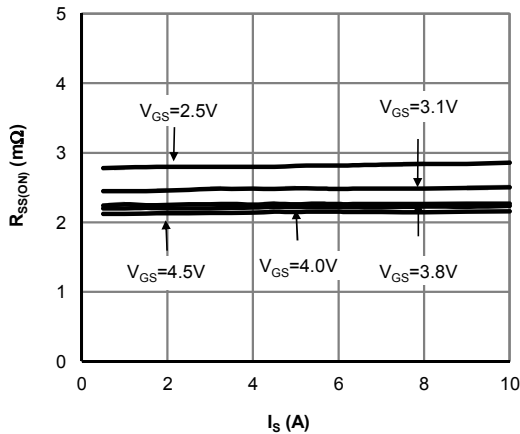

Figure 3: On-Resistance vs. Source Current and Gate Voltage

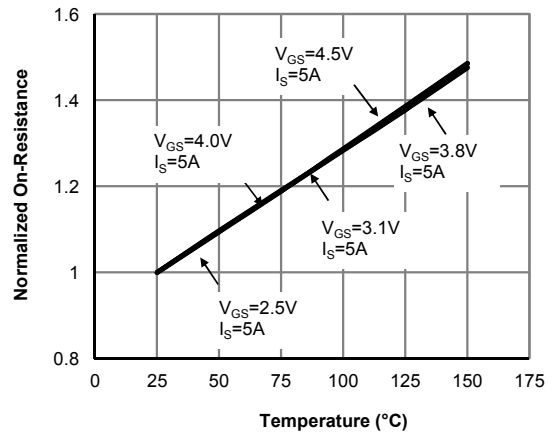

Figure 4: On-Resistance vs. Junction Temperature

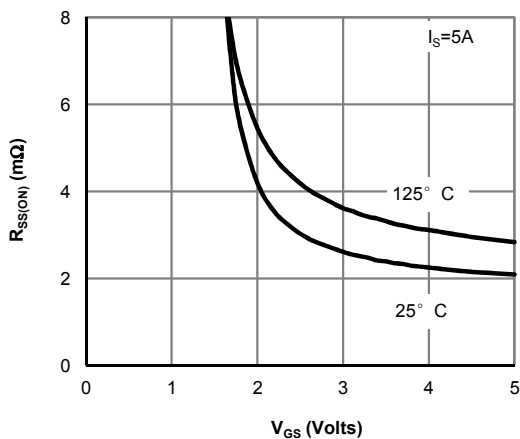

Figure 5: On-Resistance vs. Gate-Source Voltage

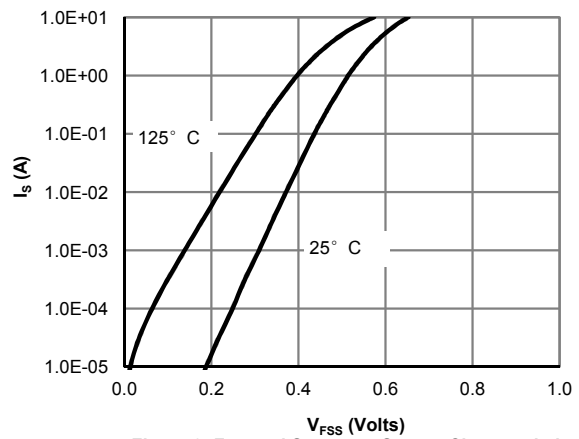

Figure 6: Forward Source to Source Characteristics

TYPICAL ELECTRICAL AND THERMAL CHARACTERISTICS

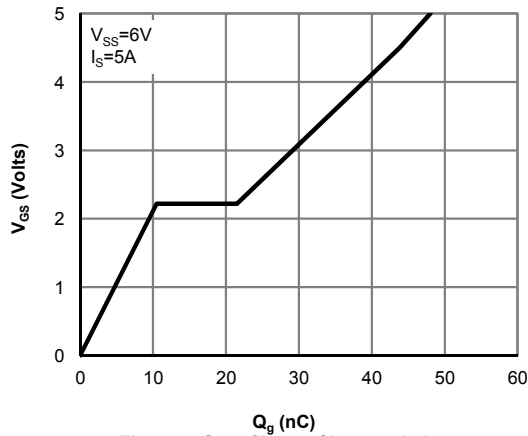

Figure 7: Gate-Charge Characteristics

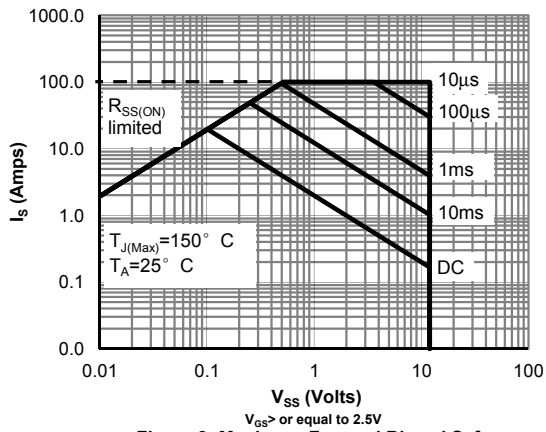

Figure 8: Maximum Forward Biased Safe Operating Area (Note1)

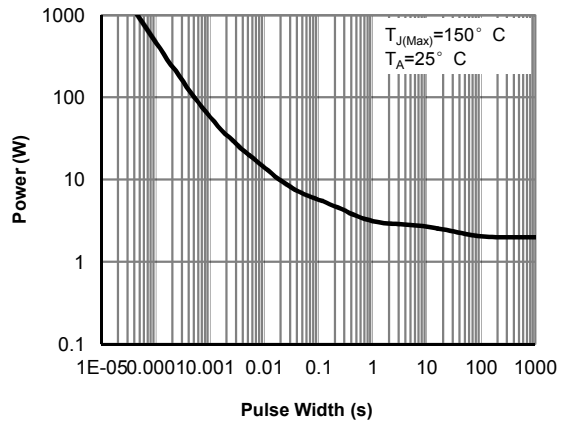

Figure 9: Single Pulse Power Rating Junction-to-Ambient (Note1)

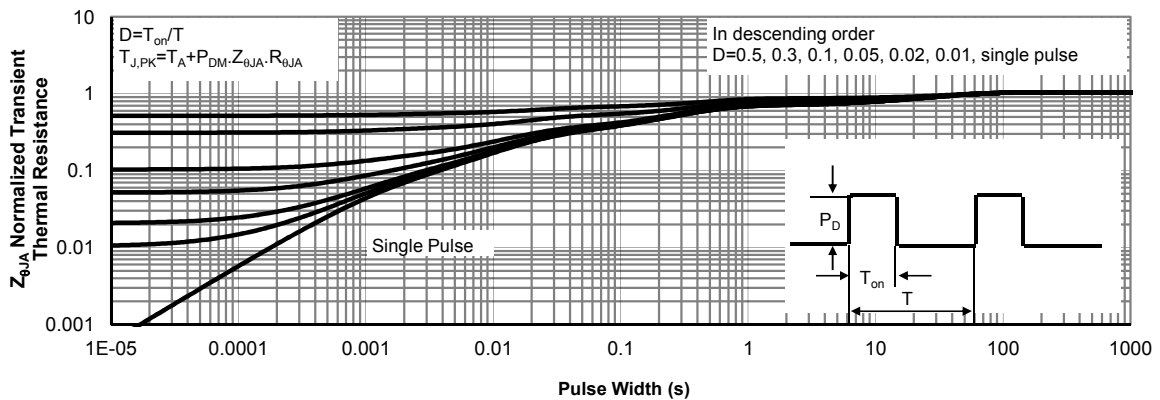
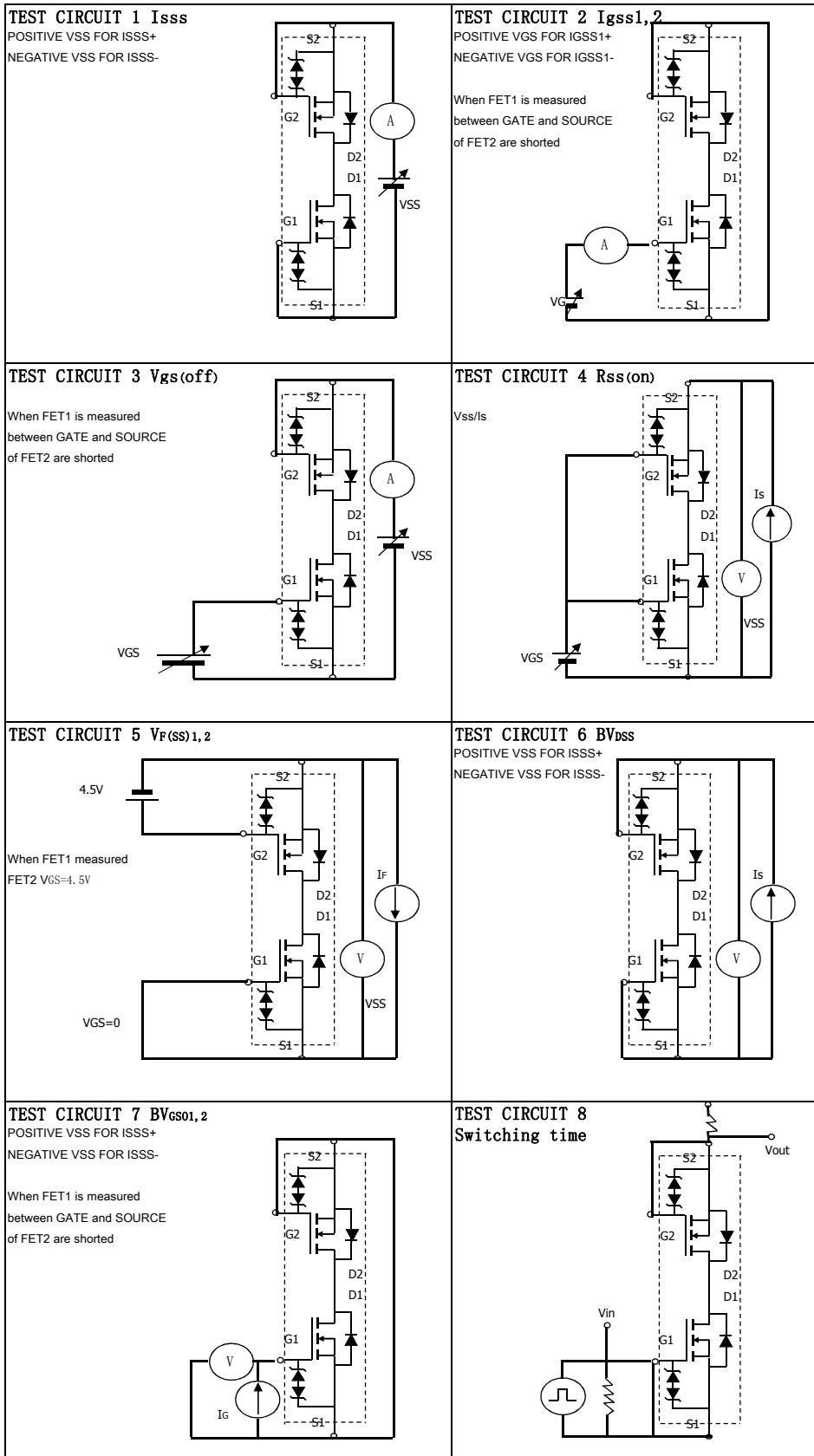

Figure 10: Normalized Maximum Transient Thermal Impedance (Note1)



单击下面可查看定价，库存，交付和生命周期等信息

[>>AOS\(万国半导体\)](#)