

AOD4189
P-Channel Enhancement Mode Field Effect Transistor
General Description

The AOD4189 uses advanced trench technology and design to provide excellent $R_{DS(ON)}$ with low gate charge. With the excellent thermal resistance of the DPAK package, this device is well suited for high current load applications.

-RoHS Compliant
 -Halogen Free*

Features

V_{DS} (V) = -40V
 I_D = -40A (V_{GS} = -10V)
 $R_{DS(ON)}$ < 22m Ω (V_{GS} = -10V)
 $R_{DS(ON)}$ < 29m Ω (V_{GS} = -4.5V)

100% UIS Tested!
100% Rg Tested!

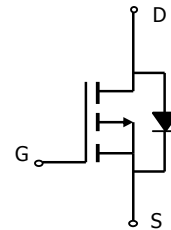
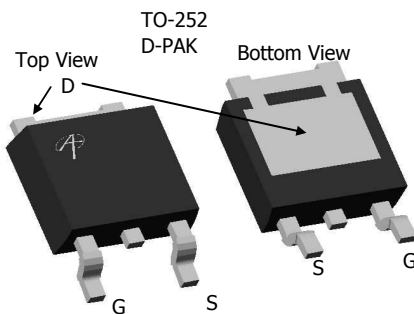
Absolute Maximum Ratings $T_C=25^\circ\text{C}$ unless otherwise noted

Parameter	Symbol	Maximum	Units
Drain-Source Voltage	V_{DS}	-40	V
Gate-Source Voltage	V_{GS}	± 20	V
Continuous Drain Current ^{B,H}	$T_C=25^\circ\text{C}$	-40	A
		$T_C=100^\circ\text{C}$	
Pulsed Drain Current ^C	I_{DM}	-50	
Avalanche Current ^C	I_{AR}	-35	
Repetitive avalanche energy $L=0.1\text{mH}$ ^C	E_{AR}	61	
Power Dissipation ^B	$T_C=25^\circ\text{C}$	62.5	W
		$T_C=100^\circ\text{C}$	
Power Dissipation ^A	$T_A=25^\circ\text{C}$	2.5	
		$T_A=70^\circ\text{C}$	
Junction and Storage Temperature Range	T_J, T_{STG}	-55 to 175	$^\circ\text{C}$

Thermal Characteristics

Parameter	Symbol	Typ	Max	Units
Maximum Junction-to-Ambient ^{A,G}	$R_{\theta JA}$	15	20	$^\circ\text{C}/\text{W}$
Maximum Junction-to-Ambient ^{A,G}		Steady-State	41	50
Maximum Junction-to-Case ^{D,F}	$R_{\theta JC}$	2	2.4	$^\circ\text{C}/\text{W}$

Electrical Characteristics ($T_J=25^\circ\text{C}$ unless otherwise noted)

Symbol	Parameter	Conditions	Min	Typ	Max	Units
STATIC PARAMETERS						
BV_{DSS}	Drain-Source Breakdown Voltage	$I_D=-250\mu\text{A}$, $V_{GS}=0\text{V}$	-40			V
I_{DSS}	Zero Gate Voltage Drain Current	$V_{DS}=-40\text{V}$, $V_{GS}=0\text{V}$ $T_J=55^\circ\text{C}$			-1 -5	μA
I_{GSS}	Gate-Body leakage current	$V_{DS}=0\text{V}$, $V_{GS}=\pm 20\text{V}$			± 100	nA
$V_{GS(th)}$	Gate Threshold Voltage	$V_{DS}=V_{GS}$, $I_D=-250\mu\text{A}$	-1.7	-1.9	-3	V
$I_{D(ON)}$	On state drain current	$V_{GS}=-10\text{V}$, $V_{DS}=-5\text{V}$	-50			A
$R_{DS(ON)}$	Static Drain-Source On-Resistance	$V_{GS}=-10\text{V}$, $I_D=-12\text{A}$ $T_J=125^\circ\text{C}$ $V_{GS}=-4.5\text{V}$, $I_D=-8\text{A}$		18 27 23	22 33 29	$\text{m}\Omega$
g_{FS}	Forward Transconductance	$V_{DS}=-5\text{V}$, $I_D=-12\text{A}$		35		S
V_{SD}	Diode Forward Voltage	$I_S=-1\text{A}$, $V_{GS}=0\text{V}$		-0.74	-1	V
I_S	Maximum Body-Diode Continuous Current				-20	A
DYNAMIC PARAMETERS						
C_{iss}	Input Capacitance	$V_{GS}=0\text{V}$, $V_{DS}=-20\text{V}$, $f=1\text{MHz}$		1870		pF
C_{oss}	Output Capacitance			185		pF
C_{rss}	Reverse Transfer Capacitance			155		pF
R_g	Gate resistance	$V_{GS}=0\text{V}$, $V_{DS}=0\text{V}$, $f=1\text{MHz}$	2.5	4.5	6.5	Ω
SWITCHING PARAMETERS						
$Q_g(-10\text{V})$	Total Gate Charge	$V_{GS}=-10\text{V}$, $V_{DS}=-20\text{V}$, $I_D=-12\text{A}$		31.4	41	nC
$Q_g(-4.5\text{V})$	Total Gate Charge			7.9	10	
Q_{gs}	Gate Source Charge			7.6		nC
Q_{gd}	Gate Drain Charge			6.2		nC
$t_{D(on)}$	Turn-On Delay Time	$V_{GS}=-10\text{V}$, $V_{DS}=-20\text{V}$, $R_L=1.6\Omega$, $R_{GEN}=3\Omega$		10		ns
t_r	Turn-On Rise Time			18		ns
$t_{D(off)}$	Turn-Off Delay Time			38		ns
t_f	Turn-Off Fall Time			24		ns
t_{rr}	Body Diode Reverse Recovery Time	$I_F=-12\text{A}$, $dI/dt=100\text{A}/\mu\text{s}$		32	42	ns
Q_{rr}	Body Diode Reverse Recovery Charge	$I_F=-12\text{A}$, $dI/dt=100\text{A}/\mu\text{s}$		30		nC

A: The value of $R_{\theta JA}$ is measured with the device in a still air environment with $T_A=25^\circ\text{C}$. The power dissipation P_{DSM} and current rating I_{DSM} are based on $T_{J(MAX)}=150^\circ\text{C}$, using steady state junction-to-ambient thermal resistance.

B: The power dissipation P_D is based on $T_{J(MAX)}=175^\circ\text{C}$, using junction-to-case thermal resistance, and is more useful in setting the upper dissipation limit for cases where additional heatsinking is used.

C: Repetitive rating, pulse width limited by junction temperature $T_{J(MAX)}=175^\circ\text{C}$.

D: The $R_{\theta JA}$ is the sum of the thermal impedance from junction to case $R_{\theta JC}$ and case to ambient.

E: The static characteristics in Figures 1 to 6 are obtained using $t \leq 300 \mu\text{s}$ pulses, duty cycle 0.5% max.

F: These curves are based on the junction-to-case thermal impedance which is measured with the device mounted to a large heatsink, assuming a maximum junction temperature of $T_{J(MAX)}=175^\circ\text{C}$. The SOA curve provides a single pulse rating.

G: These tests are performed with the device mounted on 1 in² FR-4 board with 2oz. Copper, in a still air environment with $T_A=25^\circ\text{C}$.

H: The maximum current rating is limited by bond-wires.

*This device is guaranteed green after data code 8X11 (Sep 1ST 2008).

Rev1: Oct 2008

COMPONENTS IN LIFE SUPPORT DEVICES OR SYSTEMS ARE NOT AUTHORIZED. AOS DOES NOT ASSUME ANY LIABILITY ARISING OUT OF SUCH APPLICATIONS OR USES OF ITS PRODUCTS. AOS RESERVES THE RIGHT TO IMPROVE PRODUCT DESIGN, FUNCTIONS AND RELIABILITY WITHOUT NOTICE.

TYPICAL ELECTRICAL AND THERMAL CHARACTERISTICS

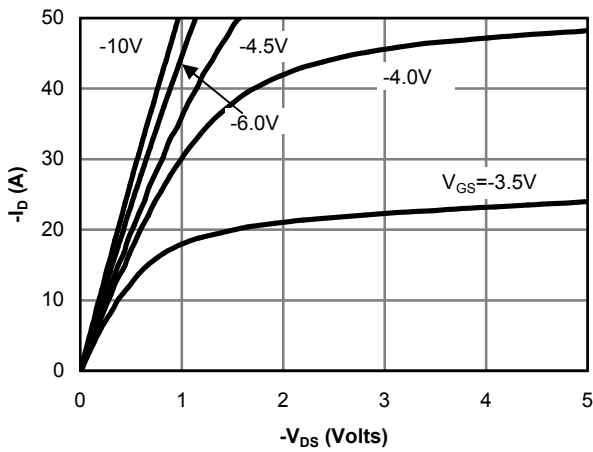

Figure 1: On-Region Characteristics

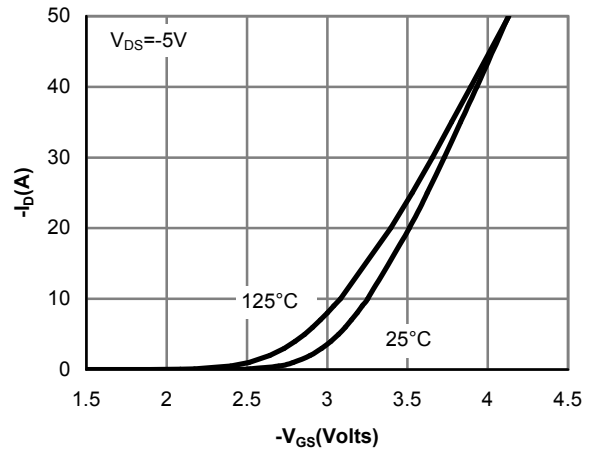

Figure 2: Transfer Characteristics

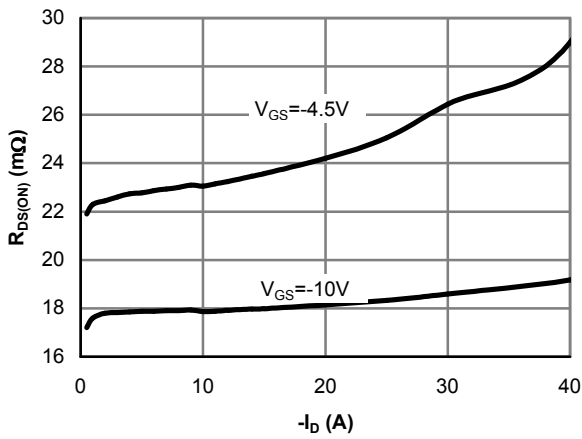

Figure 3: On-Resistance vs. Drain Current and Gate Voltage

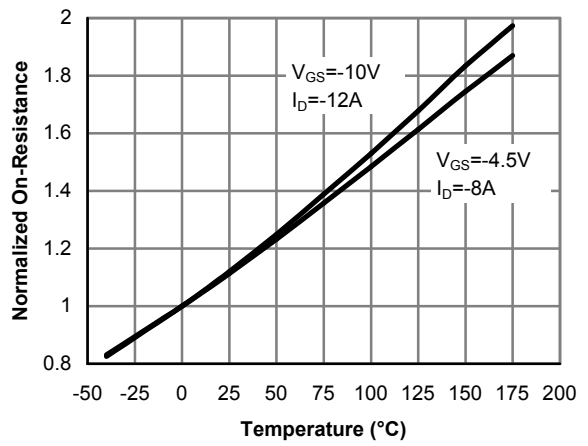

Figure 4: On-Resistance vs. Junction Temperature

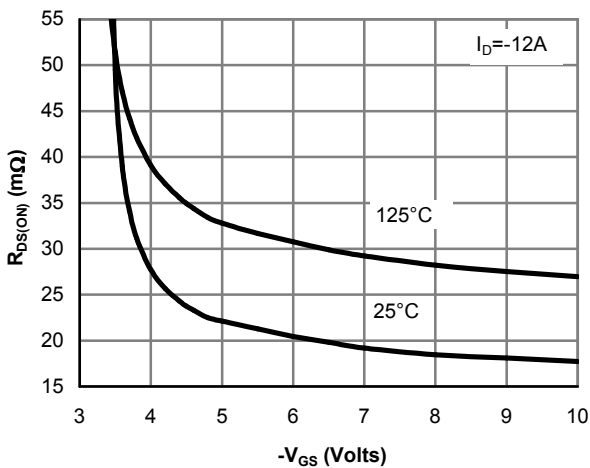

Figure 5: On-Resistance vs. Gate-Source Voltage

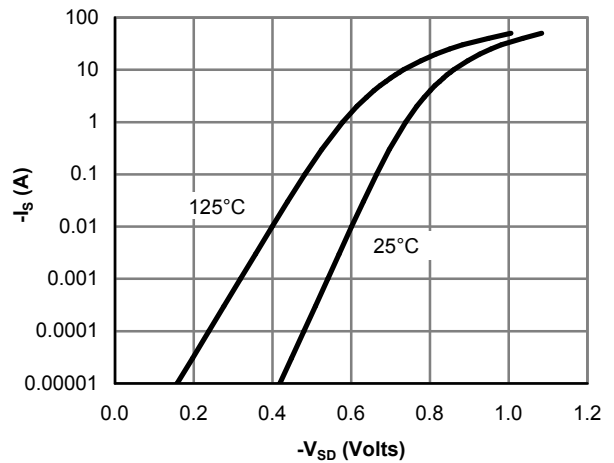

Figure 6: Body-Diode Characteristics

TYPICAL ELECTRICAL AND THERMAL CHARACTERISTICS

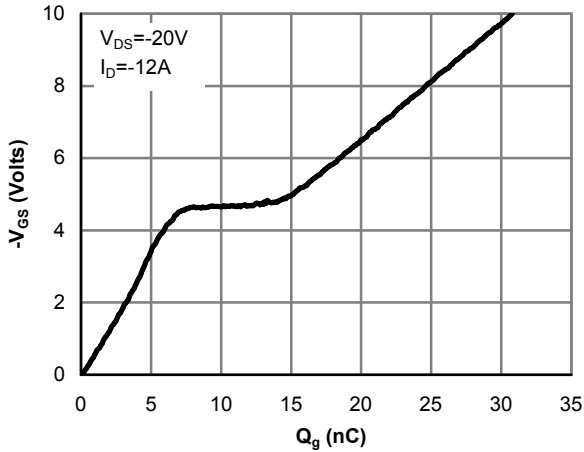

Figure 7: Gate-Charge Characteristics

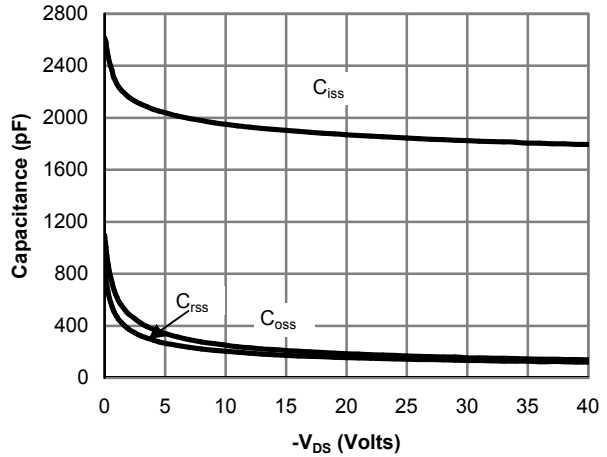

Figure 8: Capacitance Characteristics

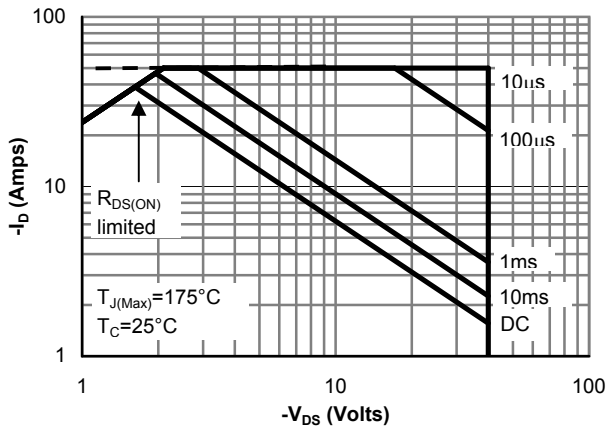

Figure 9: Maximum Forward Biased Safe Operating Area (Note F)

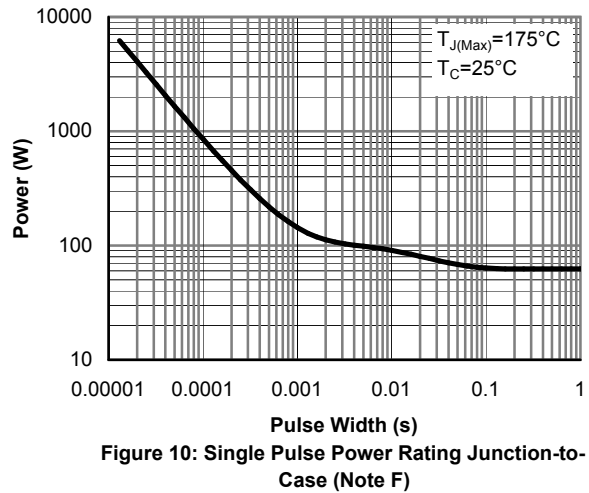

Figure 10: Single Pulse Power Rating Junction-to-Case (Note F)

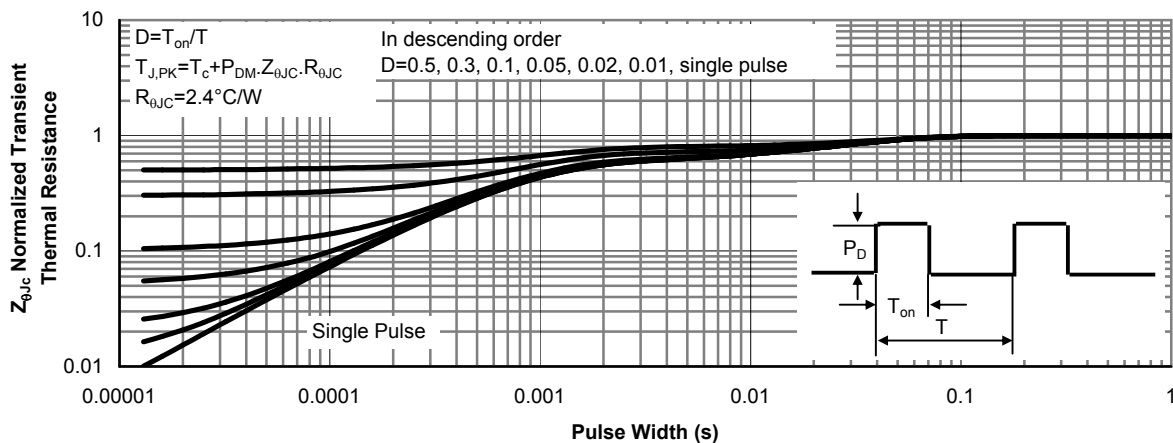

Figure 11: Normalized Maximum Transient Thermal Impedance (Note F)

TYPICAL ELECTRICAL AND THERMAL CHARACTERISTICS

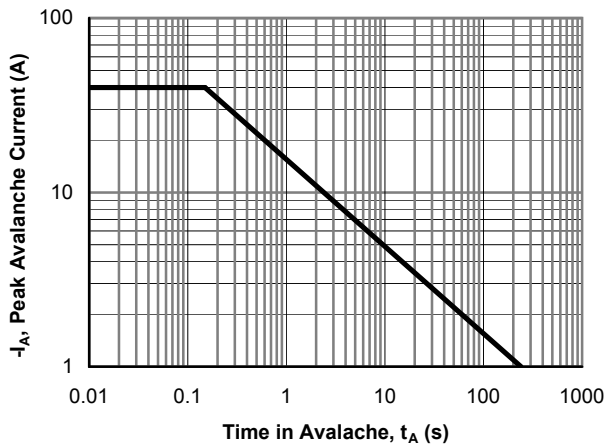

Figure 12: Single Pulse Avalanche Capability

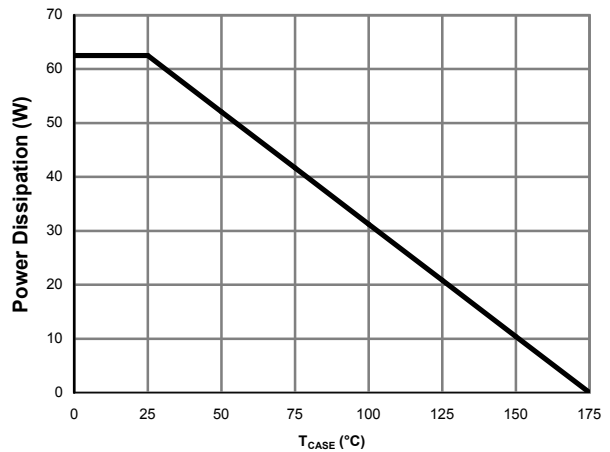

Figure 13: Power De-rating (Note B)

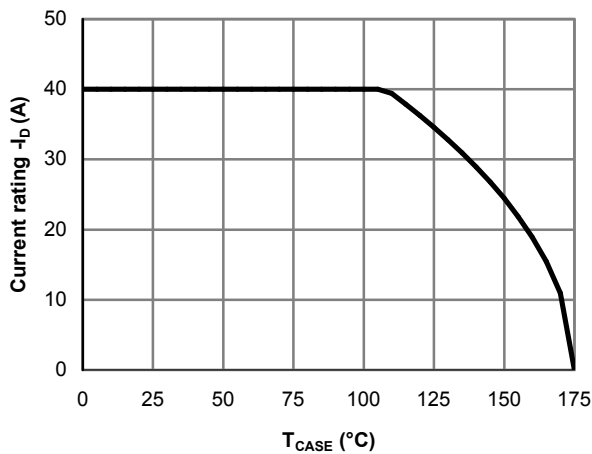

Figure 14: Current De-rating (Note B)

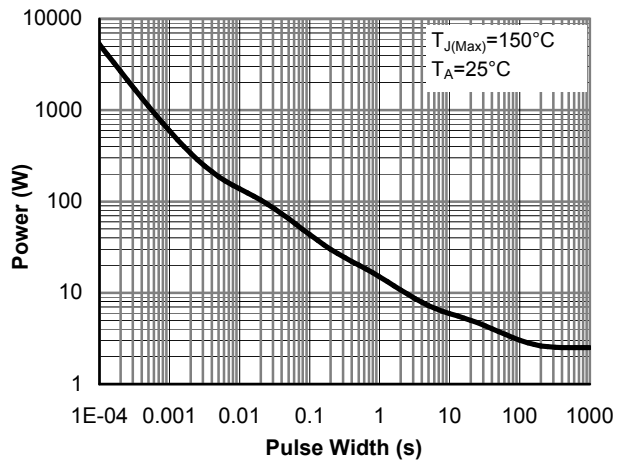

Figure 15: Single Pulse Power Rating Junction-to-Ambient (Note G)

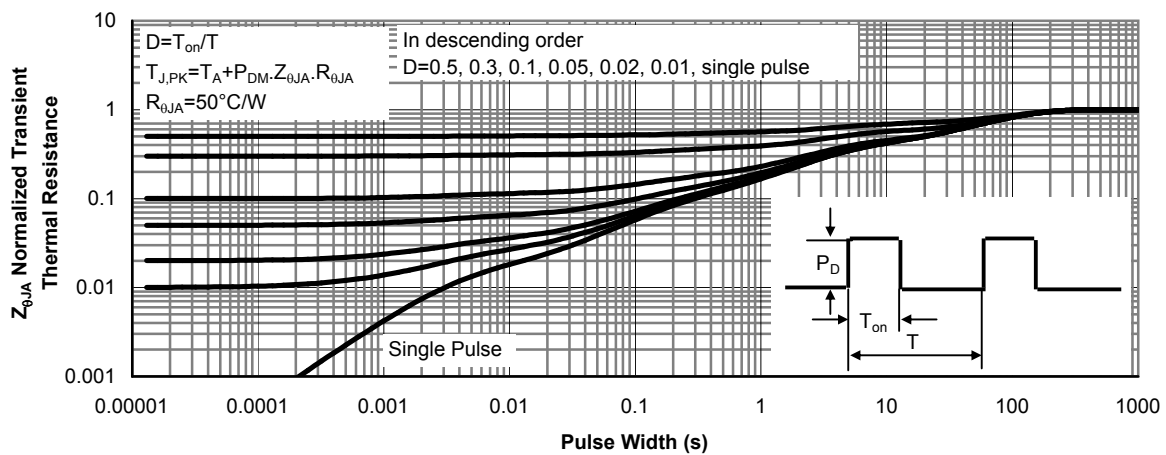
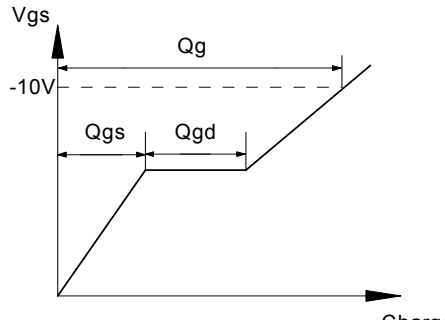
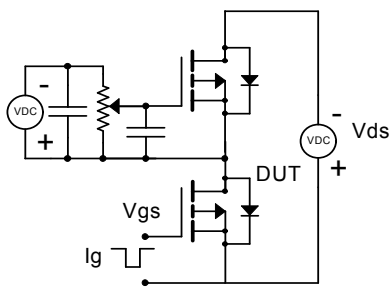
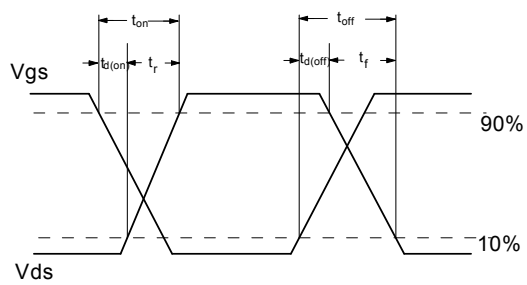
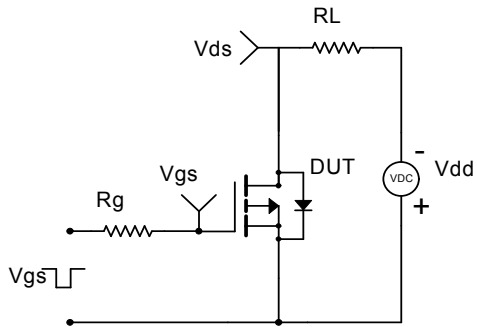

Figure 16: Normalized Maximum Transient Thermal Impedance (Note G)

Gate Charge Test Circuit & Waveform



Resistive Switching Test Circuit & Waveforms



Unclamped Inductive Switching (UIS) Test Circuit & Waveforms

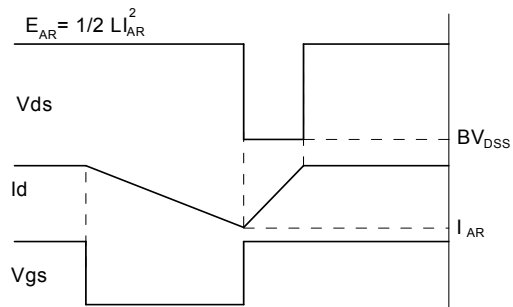
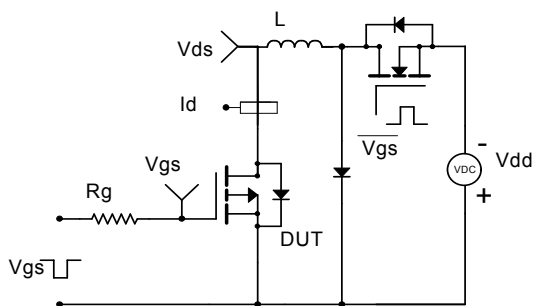

Diode Recovery Test Circuit & Waveforms

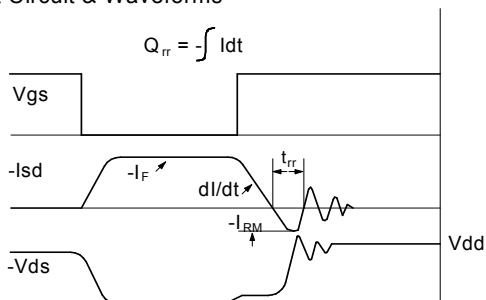
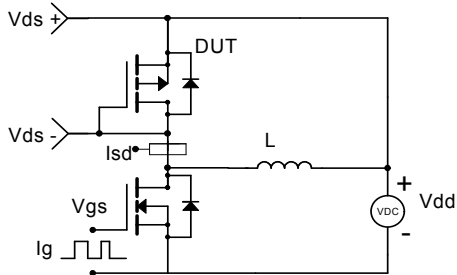

单击下面可查看定价，库存，交付和生命周期等信息

[>>AOS\(万国半导体\)](#)