

General Description

The Alpha IGBT™ line of products offers best-in-class performance in conduction and switching losses, with robust short circuit capability. They are designed for ease of paralleling, minimal gate spike under high dV/dt conditions and resistance to oscillations. The soft co-package diode is targeted for minimal losses in motor control applications.

Product Summary

V_{CE}	600V
I_C ($T_C=100^\circ\text{C}$)	15A
$V_{CE(sat)}$ ($T_C=25^\circ\text{C}$)	1.6V

100% E_{on}/E_{off} Tested
 100% Q_{rr} Tested
 100% Short Circuit Current Tested*



Top View

TO-247

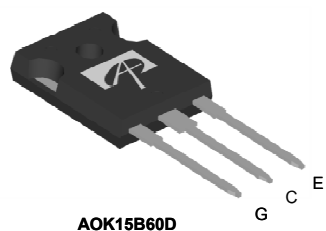

AOK15B60D

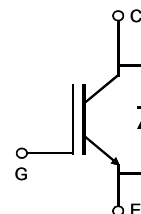

Absolute Maximum Ratings $T_A=25^\circ\text{C}$ unless otherwise noted

Parameter	Symbol	AOK15B60D	Units
Collector-Emitter Voltage	V_{CE}	600	V
Gate-Emitter Voltage	V_{GE}	± 20	V
Continuous Collector Current	I_C	$T_C=25^\circ\text{C}$	30
		$T_C=100^\circ\text{C}$	15
Pulsed Collector Current, Limited by T_{Jmax}	I_{CM}	60	A
Turn off SOA, $V_{CE} \leq 600\text{V}$, Limited by T_{Jmax}	I_{LM}	60	A
Continuous Diode Forward Current	I_F	$T_C=25^\circ\text{C}$	30
		$T_C=100^\circ\text{C}$	15
Diode Pulsed Current, Limited by T_{Jmax}	I_{FM}	60	A
Short circuit withstanding time $V_{GE} = 15\text{V}$, $V_{CE} \leq 400\text{V}$, Delay between short circuits $\geq 1.0\text{s}$, $T_C=25^\circ\text{C}$	t_{SC}	10	μs
Power Dissipation	P_D	$T_C=25^\circ\text{C}$	167
		$T_C=100^\circ\text{C}$	83.3
Junction and Storage Temperature Range	T_J, T_{STG}	-55 to 175	$^\circ\text{C}$
Maximum lead temperature for soldering purpose, 1/8" from case for 5 seconds	T_L	300	$^\circ\text{C}$

Thermal Characteristics

Parameter	Symbol	AOK15B60D	Units
Maximum Junction-to-Ambient	$R_{\theta JA}$	40	$^\circ\text{C}/\text{W}$
Maximum IGBT Junction-to-Case	$R_{\theta JC}$	0.9	$^\circ\text{C}/\text{W}$
Maximum Diode Junction-to-Case	$R_{\theta JC}$	1.5	$^\circ\text{C}/\text{W}$

* V_{CE} equal to 50V

Electrical Characteristics (T_J=25°C unless otherwise noted)

Symbol	Parameter	Conditions	Min	Typ	Max	Units	
STATIC PARAMETERS							
BV_{CES}	Collector-Emitter Breakdown Voltage	$I_C=250\mu A, V_{GE}=0V, T_J=25^\circ C$	600	-	-	V	
$V_{CE(sat)}$	Collector-Emitter Saturation Voltage	$V_{GE}=15V, I_C=15A$	$T_J=25^\circ C$	-	1.6	1.8	V
			$T_J=125^\circ C$	-	1.85	-	
			$T_J=175^\circ C$	-	1.99	-	
V_F	Diode Forward Voltage	$V_{GE}=0V, I_C=15A$	$T_J=25^\circ C$	-	1.43	1.72	V
			$T_J=125^\circ C$	-	1.39	-	
			$T_J=175^\circ C$	-	1.32	-	
$V_{GE(th)}$	Gate-Emitter Threshold Voltage	$V_{CE}=V_{GE}, I_C=250\mu A$	-	5.6	-	V	
I_{CES}	Zero Gate Voltage Collector Current	$V_{CE}=600V, V_{GE}=0V$	$T_J=25^\circ C$	-	-	10	μA
			$T_J=125^\circ C$	-	-	300	
			$T_J=175^\circ C$	-	-	3000	
I_{GES}	Gate-Emitter leakage current	$V_{CE}=0V, V_{GE}=\pm 20V$	-	-	± 100	nA	
g_{FS}	Forward Transconductance	$V_{CE}=20V, I_C=15A$	-	7.7	-	S	
DYNAMIC PARAMETERS							
C_{ies}	Input Capacitance	$V_{GE}=0V, V_{CE}=25V, f=1MHz$	-	1290	-	pF	
C_{oes}	Output Capacitance		-	97	-	pF	
C_{res}	Reverse Transfer Capacitance		-	3.1	-	pF	
Q_g	Total Gate Charge	$V_{GE}=15V, V_{CE}=480V, I_C=15A$	-	25.4	-	nC	
Q_{ge}	Gate to Emitter Charge		-	9.5	-	nC	
Q_{gc}	Gate to Collector Charge		-	8.3	-	nC	
$I_{C(SC)}$	Short circuit collector current, Max. 1000 short circuits, Delay between short circuits $\geq 1.0s$	$V_{GE}=15V, V_{CE}=400V, R_G=20\Omega$	-	74	-	A	
R_g	Gate resistance	$V_{GE}=0V, V_{CE}=0V, f=1MHz$	-	2.4	-	Ω	
SWITCHING PARAMETERS, (Load Inductive, T_J=25°C)							
$t_{D(on)}$	Turn-On DelayTime	$T_J=25^\circ C, V_{GE}=15V, V_{CE}=400V, I_C=15A, R_G=20\Omega, \text{Parasitic Inductance}=150nH$	-	23	-	ns	
t_r	Turn-On Rise Time		-	27	-	ns	
$t_{D(off)}$	Turn-Off Delay Time		-	74	-	ns	
t_f	Turn-Off Fall Time		-	8	-	ns	
E_{on}	Turn-On Energy		-	0.51	-	mJ	
E_{off}	Turn-Off Energy		-	0.11	-	mJ	
E_{total}	Total Switching Energy		-	0.62	-	mJ	
t_{rr}	Diode Reverse Recovery Time		$T_J=25^\circ C$	-	196	-	ns
Q_{rr}	Diode Reverse Recovery Charge		$I_F=15A, di/dt=200A/\mu s, V_{CE}=400V$	-	0.48	-	μC
I_{rm}	Diode Peak Reverse Recovery Current			-	5.8	-	A
SWITCHING PARAMETERS, (Load Inductive, T_J=175°C)							
$t_{D(on)}$	Turn-On DelayTime	$T_J=175^\circ C, V_{GE}=15V, V_{CE}=400V, I_C=15A, R_G=20\Omega, \text{Parasitic Inductance}=150nH$	-	20	-	ns	
t_r	Turn-On Rise Time		-	28	-	ns	
$t_{D(off)}$	Turn-Off Delay Time		-	95	-	ns	
t_f	Turn-Off Fall Time		-	10	-	ns	
E_{on}	Turn-On Energy		-	0.69	-	mJ	
E_{off}	Turn-Off Energy		-	0.2	-	mJ	
E_{total}	Total Switching Energy		-	0.89	-	mJ	
t_{rr}	Diode Reverse Recovery Time		$T_J=175^\circ C$	-	235	-	ns
Q_{rr}	Diode Reverse Recovery Charge		$I_F=15A, di/dt=200A/\mu s, V_{CE}=400V$	-	1.1	-	μC
I_{rm}	Diode Peak Reverse Recovery Current			-	8.5	-	A

THIS PRODUCT HAS BEEN DESIGNED AND QUALIFIED FOR THE CONSUMER MARKET. APPLICATIONS OR USES AS CRITICAL COMPONENTS IN LIFE SUPPORT DEVICES OR SYSTEMS ARE NOT AUTHORIZED. AOS DOES NOT ASSUME ANY LIABILITY ARISING OUT OF SUCH APPLICATIONS OR USES OF ITS PRODUCTS. AOS RESERVES THE RIGHT TO IMPROVE PRODUCT DESIGN, FUNCTIONS AND RELIABILITY WITHOUT NOTICE.

TYPICAL ELECTRICAL AND THERMAL CHARACTERISTICS

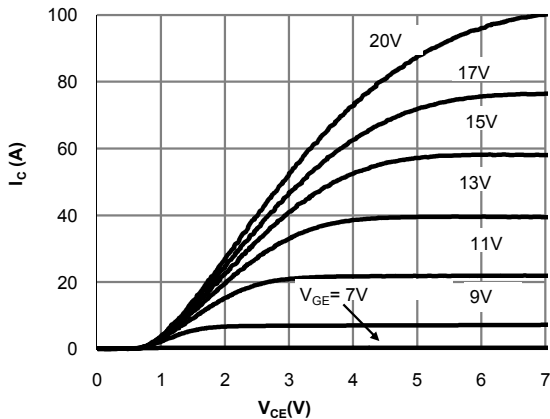

Fig 1: Output Characteristic
($T_j=25^\circ\text{C}$)

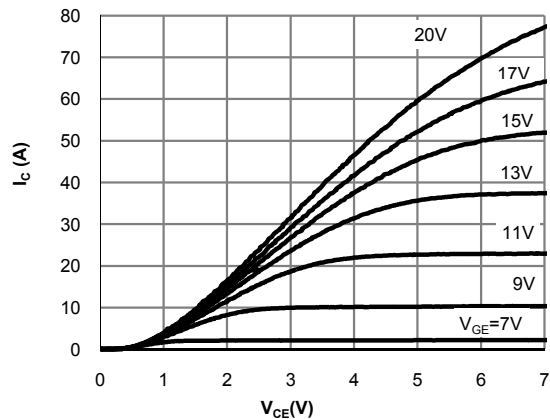

Fig 2: Output Characteristic
($T_j=175^\circ\text{C}$)

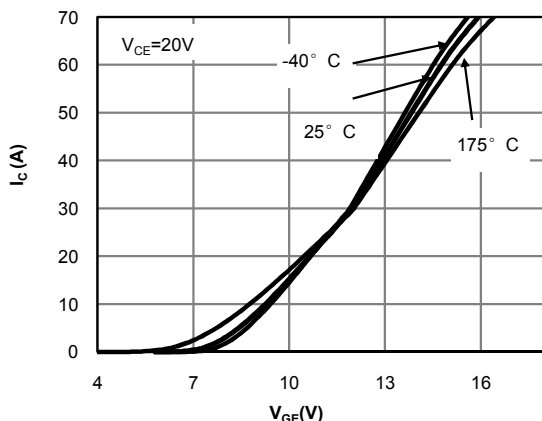

Fig 3: Transfer Characteristic

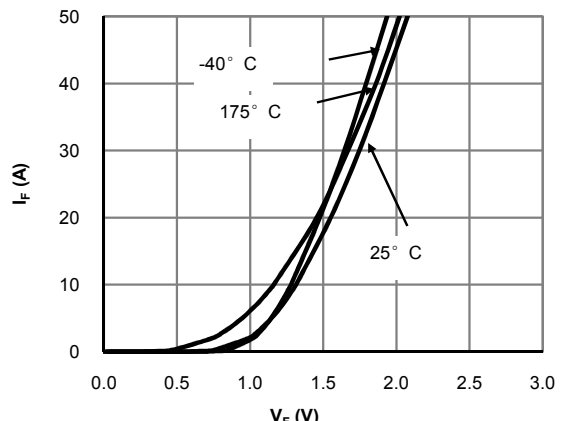

Fig 4: Diode Characteristic

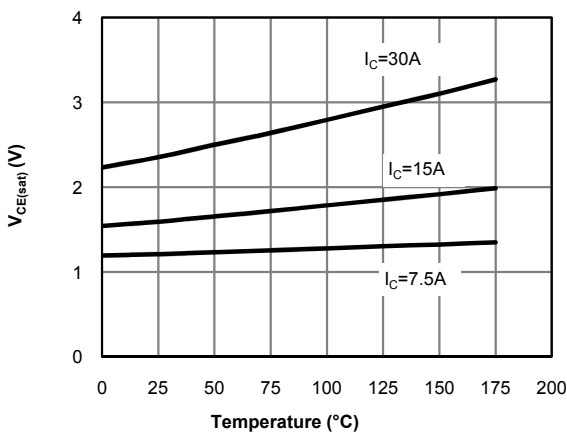

Fig 5: Collector-Emitter Saturation Voltage vs. Junction Temperature

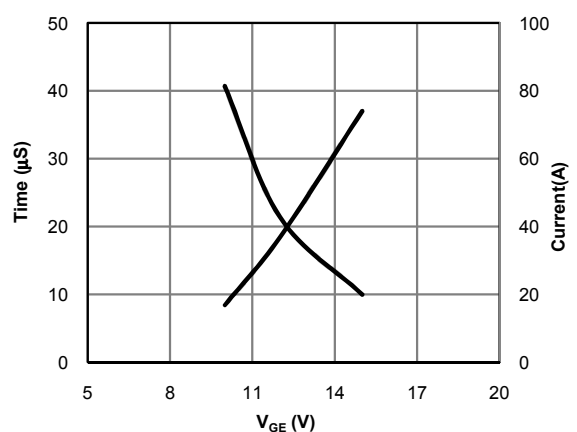

Fig 6: V_{GE} vs. Short Circuit Time
($V_{CE}=400\text{V}, T_c=25^\circ\text{C}$)

TYPICAL ELECTRICAL AND THERMAL CHARACTERISTICS

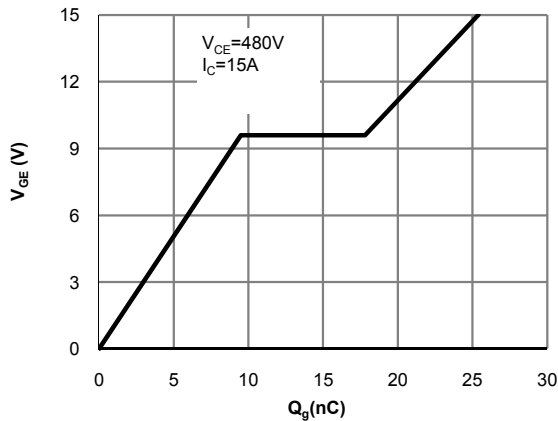

Fig 7: Gate-Charge Characteristics

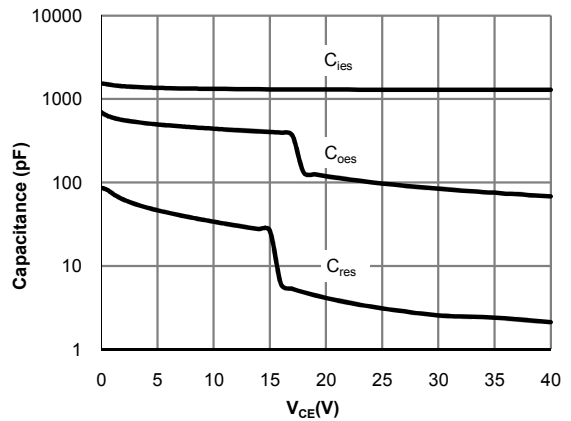

Fig 8: Capacitance Characteristic

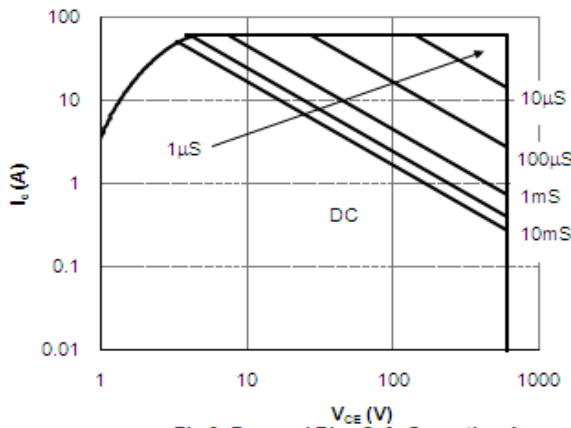

Fig 9: Forward Bias Safe Operating Area
($T_C=25^\circ\text{C}, V_{GE}=15\text{V}$)

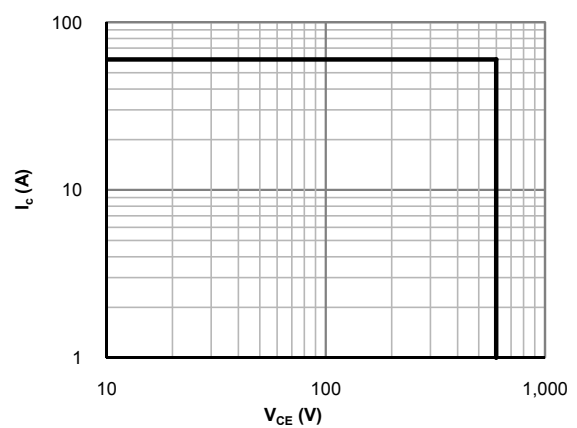

Fig 10: Reverse Bias SOA
($T_J=175^\circ\text{C}, V_{GE}=15\text{V}$)

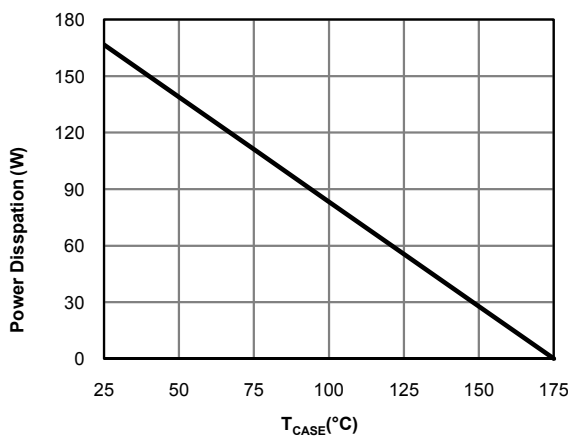

Fig 11: Power Dissipation as a Function of Case

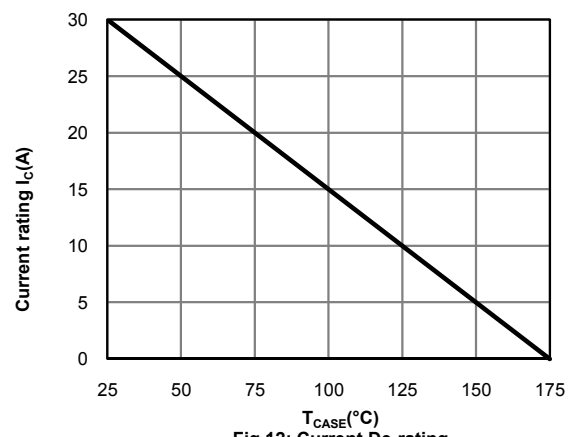

Fig 12: Current De-rating

TYPICAL ELECTRICAL AND THERMAL CHARACTERISTICS

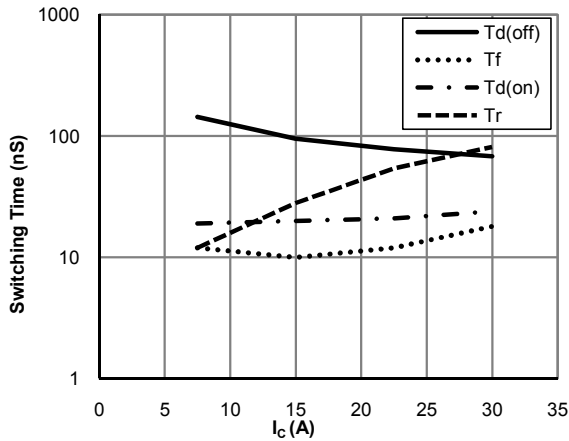

Figure 13: Switching Time vs. I_c
($T_j=175^\circ\text{C}, V_{GE}=15\text{V}, V_{CE}=400\text{V}, R_g=20\Omega$)

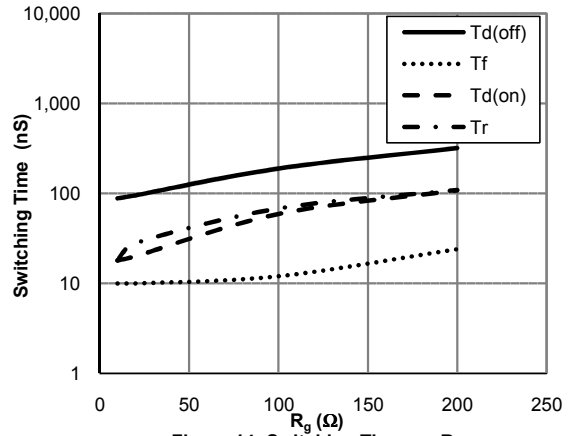

Figure 14: Switching Time vs. R_g
($T_j=175^\circ\text{C}, V_{GE}=15\text{V}, V_{CE}=400\text{V}, I_c=15\text{A}$)

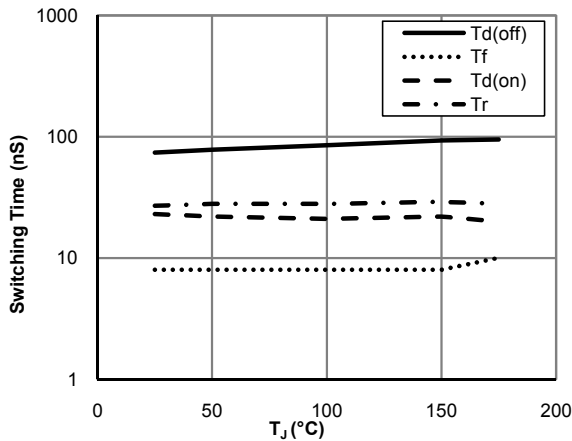

Figure 15: Switching Time vs. T_j
($V_{GE}=15\text{V}, V_{CE}=400\text{V}, I_c=15\text{A}, R_g=20\Omega$)

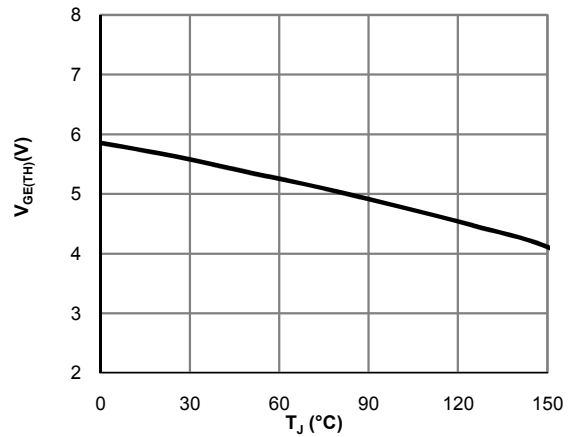

Figure 16: $V_{GE(TH)}$ vs. T_j

TYPICAL ELECTRICAL AND THERMAL CHARACTERISTICS

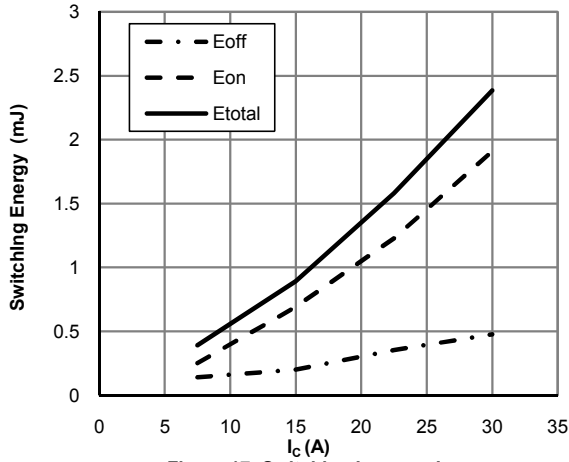

Figure 17: Switching Loss vs. I_C
($T_J=175^\circ\text{C}, V_{GE}=15\text{V}, V_{CE}=400\text{V}, R_g=20\Omega$)

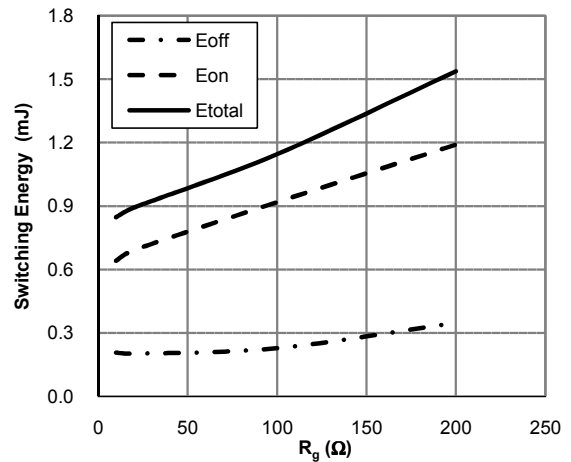

Figure 18: Switching Loss vs. R_g
($T_J=175^\circ\text{C}, V_{GE}=15\text{V}, V_{CE}=400\text{V}, I_C=15\text{A}$)

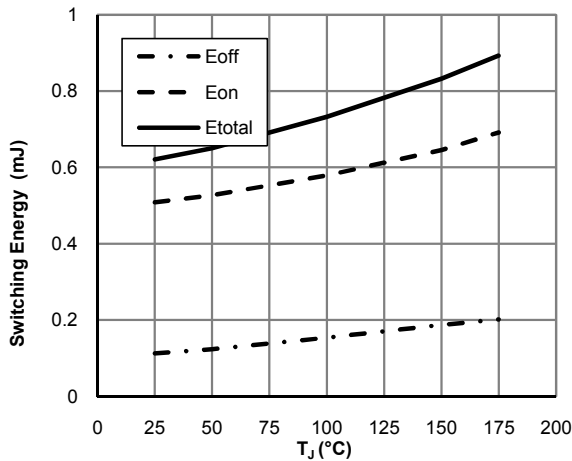

Figure 19: Switching Loss vs. T_J
($V_{GE}=15\text{V}, V_{CE}=400\text{V}, I_C=15\text{A}, R_g=20\Omega$)

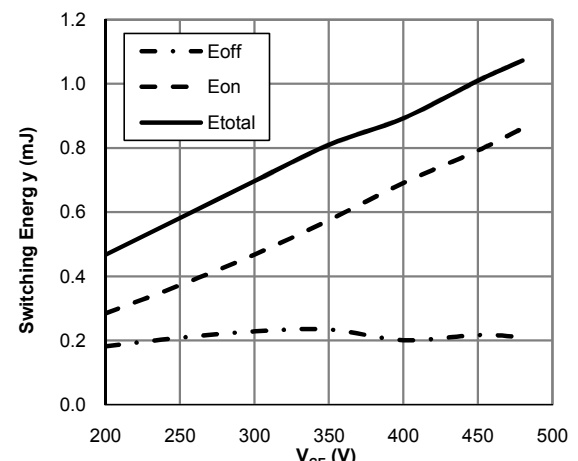

Figure 20: Switching Loss vs. V_{CE}
($T_J=175^\circ\text{C}, V_{GE}=15\text{V}, I_C=15\text{A}, R_g=20\Omega$)

TYPICAL ELECTRICAL AND THERMAL CHARACTERISTICS

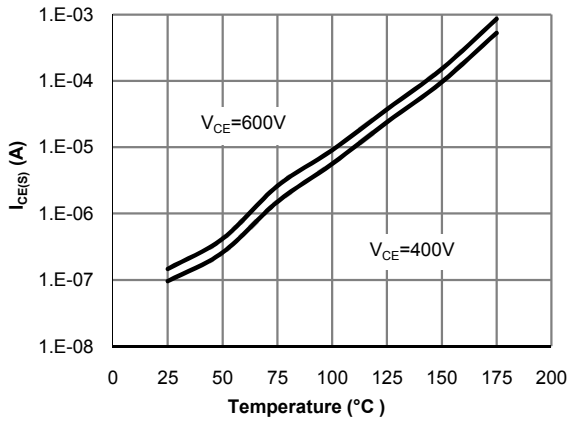

Fig 21: Diode Reverse Leakage Current vs. Junction Temperature

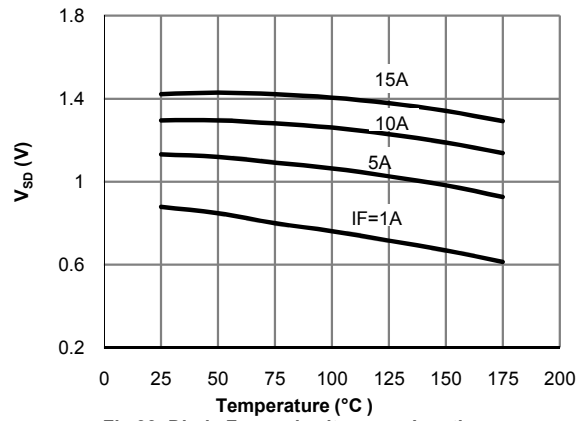

Fig 22: Diode Forward Voltage vs. Junction Temperature

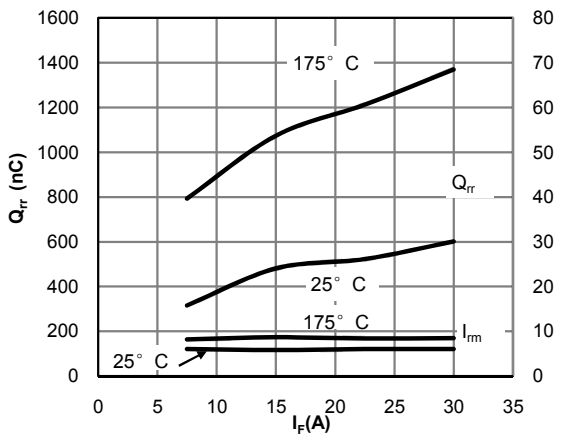

Fig 23: Diode Reverse Recovery Charge and Peak Current vs. Conduction Current
($V_{GE}=15V, V_{CE}=400V, di/dt=200A/\mu s$)

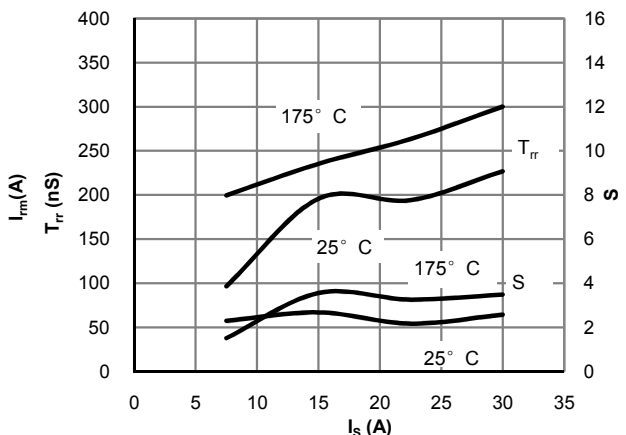

Fig 24: Diode Reverse Recovery Time and Softness Factor vs. Conduction Current
($V_{GE}=15V, V_{CE}=400V, di/dt=200A/\mu s$)

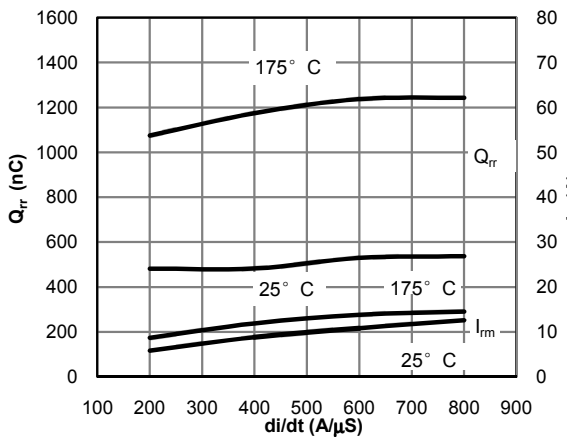

Fig 25: Diode Reverse Recovery Charge and Peak Current vs. di/dt
($V_{GE}=15V, V_{CE}=400V, I_F=15A$)

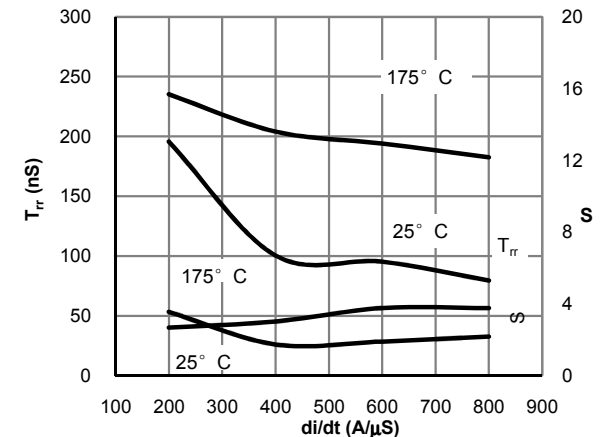

Fig 26: Diode Reverse Recovery Time and Softness Factor vs. di/dt
($V_{GE}=15V, V_{CE}=400V, I_F=15A$)

TYPICAL ELECTRICAL AND THERMAL CHARACTERISTICS

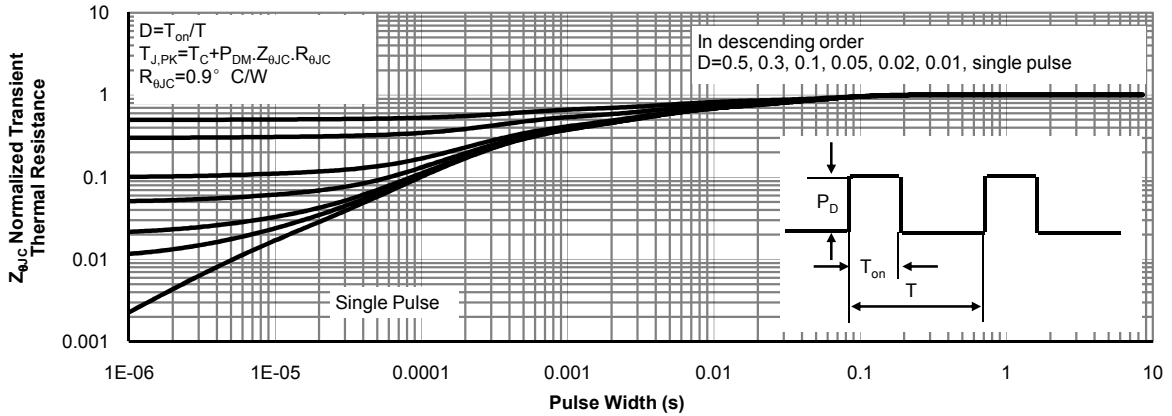

Figure 27: Normalized Maximum Transient Thermal Impedance for IGBT

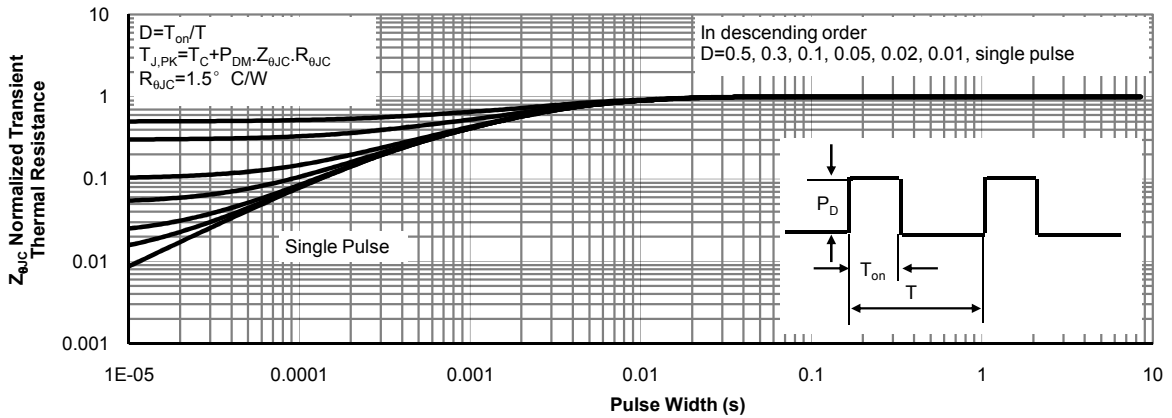
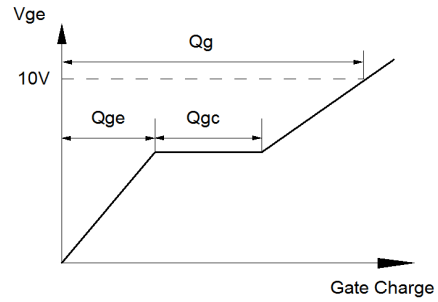

Figure 28: Normalized Maximum Transient Thermal Impedance for Diode

Gate Charge Test Circuit & Waveform



Inductive Switching Test Circuit & Waveforms



Diode Recovery Test Circuit & Waveforms

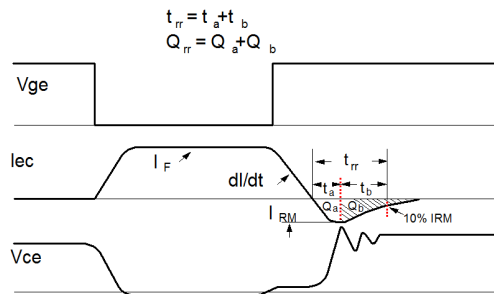
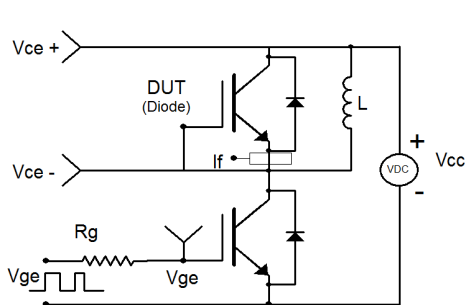

单击下面可查看定价，库存，交付和生命周期等信息

[>>AOS\(万国半导体\)](#)