

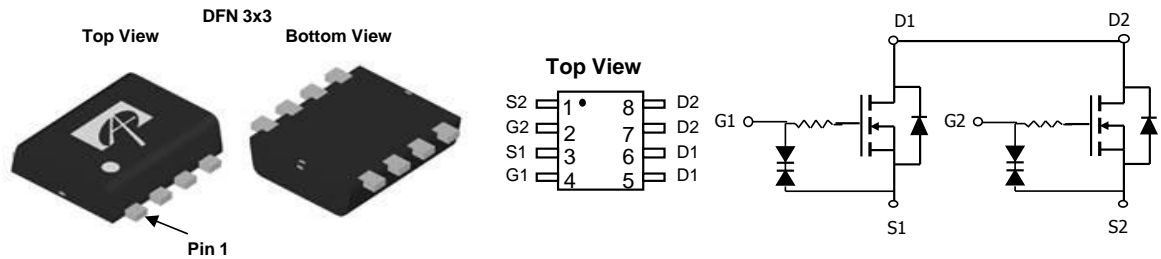
### General Description

The AON3814 uses advanced trench technology to provide excellent  $R_{DS(ON)}$ , low gate charge and operation with gate voltages as low as 1.8V while retaining a 12V  $V_{GS(MAX)}$  rating. It is ESD protected. This device is suitable for use as a uni-directional or bi-directional load switch, facilitated by its common-drain configuration.

### Product Summary

$V_{DS}$	20V
$I_D$ (at $V_{GS}=4.5V$ )	6A
$R_{DS(ON)}$ (at $V_{GS} = 4.5V$ )	< 17m $\Omega$
$R_{DS(ON)}$ (at $V_{GS} = 4V$ )	< 18.5m $\Omega$
$R_{DS(ON)}$ (at $V_{GS} = 3.1V$ )	< 23m $\Omega$
$R_{DS(ON)}$ (at $V_{GS} = 2.5V$ )	< 24m $\Omega$

ESD Protected



### Absolute Maximum Ratings $T_A=25^\circ C$ unless otherwise noted

Parameter	Symbol	Maximum	Units
Drain-Source Voltage	$V_{DS}$	20	V
Gate-Source Voltage	$V_{GS}$	$\pm 12$	V
Continuous Drain Current <sup>F</sup>	$I_D$	$T_C=25^\circ C$	6
		$T_C=70^\circ C$	5.3
Pulsed Drain Current <sup>B</sup>	$I_{DM}$	40	A
Power Dissipation <sup>F</sup>	$P_D$	$T_C=25^\circ C$	2.5
		$T_C=70^\circ C$	1.6
Junction and Storage Temperature Range	$T_J, T_{STG}$	-55 to 150	$^\circ C$

### Thermal Characteristics

Parameter	Symbol	Typ	Max	Units
Maximum Junction-to-Ambient <sup>A</sup>	$R_{\theta JA}$	40	50	$^\circ C/W$
Maximum Junction-to-Ambient <sup>A</sup>		Steady-State	75	95
Maximum Junction-to-Lead <sup>C</sup>	$R_{\theta JL}$	30	40	$^\circ C/W$

**Electrical Characteristics (T<sub>J</sub>=25°C unless otherwise noted)**

Symbol	Parameter	Conditions	Min	Typ	Max	Units
<b>STATIC PARAMETERS</b>						
BV <sub>DSS</sub>	Drain-Source Breakdown Voltage	I <sub>D</sub> =250μA, V <sub>GS</sub> =0V	20			V
I <sub>DSS</sub>	Zero Gate Voltage Drain Current	V <sub>DS</sub> =20V, V <sub>GS</sub> =0V T <sub>J</sub> =55°C			1 5	μA
I <sub>GSS</sub>	Gate-Body leakage current	V <sub>DS</sub> =0V, V <sub>GS</sub> = ±10V			10	μA
V <sub>GS(th)</sub>	Gate Threshold Voltage	V <sub>DS</sub> =V <sub>GS</sub> I <sub>D</sub> =250μA	0.3	0.7	1.1	V
I <sub>D(ON)</sub>	On state drain current	V <sub>GS</sub> =4.5V, V <sub>DS</sub> =5V	40			A
R <sub>DS(ON)</sub>	Static Drain-Source On-Resistance	V <sub>GS</sub> =4.5V, I <sub>D</sub> =6A T <sub>J</sub> =125°C		12.5 18.5	17 24	mΩ
		V <sub>GS</sub> =4V, I <sub>D</sub> =6A		12.9	18.5	mΩ
		V <sub>GS</sub> =3.1V, I <sub>D</sub> =6A		14	23	mΩ
		V <sub>GS</sub> =2.5V, I <sub>D</sub> =6A		15.6	24	mΩ
		V <sub>GS</sub> =1.8V, I <sub>D</sub> =6A		23		mΩ
g <sub>FS</sub>	Forward Transconductance	V <sub>DS</sub> =5V, I <sub>D</sub> =6A		33		S
V <sub>SD</sub>	Diode Forward Voltage	I <sub>S</sub> =1A, V <sub>GS</sub> =0V		0.6	1	V
I <sub>S</sub>	Maximum Body-Diode Continuous Current				3.5	A
<b>DYNAMIC PARAMETERS</b>						
C <sub>iss</sub>	Input Capacitance	V <sub>GS</sub> =0V, V <sub>DS</sub> =10V, f=1MHz	730	920	1100	pF
C <sub>oss</sub>	Output Capacitance		110	155	200	pF
C <sub>rss</sub>	Reverse Transfer Capacitance		45	75	105	pF
R <sub>g</sub>	Gate resistance	V <sub>GS</sub> =0V, V <sub>DS</sub> =0V, f=1MHz		2.4		kΩ
<b>SWITCHING PARAMETERS</b>						
Q <sub>g</sub>	Total Gate Charge	V <sub>GS</sub> =4.5V, V <sub>DS</sub> =10V, I <sub>D</sub> =6A	8.8	11	13	nC
Q <sub>gs</sub>	Gate Source Charge		1.6	2	2.4	nC
Q <sub>gd</sub>	Gate Drain Charge		1.9	3.2	4.5	nC
t <sub>D(on)</sub>	Turn-On DelayTime	V <sub>GS</sub> =5V, V <sub>DS</sub> =10V, R <sub>L</sub> =1.7Ω, R <sub>GEN</sub> =3Ω		0.3		μs
t <sub>r</sub>	Turn-On Rise Time			0.6		μs
t <sub>D(off)</sub>	Turn-Off DelayTime			7.9		μs
t <sub>f</sub>	Turn-Off Fall Time			4.4		μs

A. The value of R<sub>θJA</sub> is measured with the device mounted on 1in<sup>2</sup> FR-4 board with 2oz. Copper, in a still air environment with T<sub>A</sub> =25° C. The value in any given application depends on the user's specific board design.

B. The power dissipation P<sub>D</sub> is based on T<sub>J(MAX)</sub>=150° C, using ≤ 10s junction-to-ambient thermal resistance.

C. Repetitive rating, pulse width limited by junction temperature T<sub>J(MAX)</sub>=150° C. Ratings are based on low frequency and duty cycles to keep initial T<sub>J</sub>=25° C.

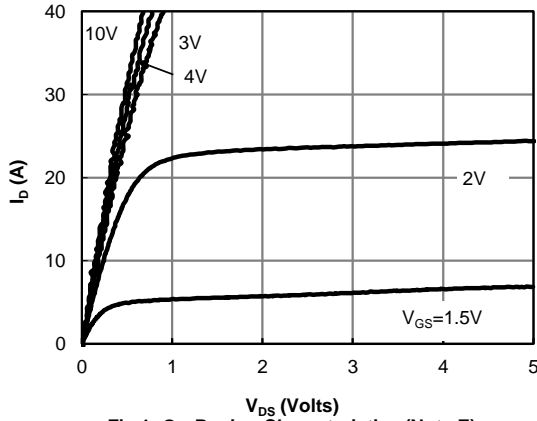
D. The R<sub>θJA</sub> is the sum of the thermal impedance from junction to lead R<sub>θJL</sub> and lead to ambient.

E. The static characteristics in Figures 1 to 6 are obtained using <300μs pulses, duty cycle 0.5% max.

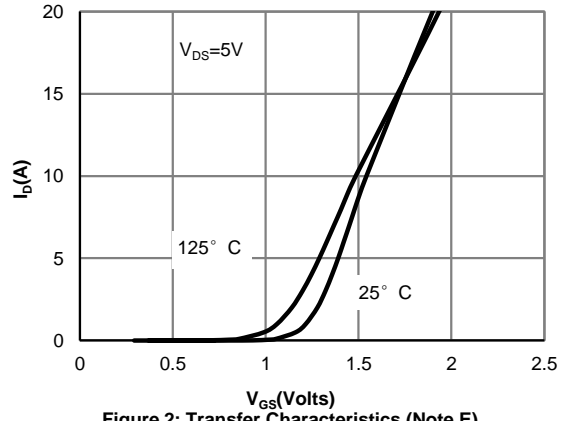
F. These curves are based on the junction-to-ambient thermal impedance which is measured with the device mounted on 1in<sup>2</sup> FR-4 board with 2oz. Copper, assuming a maximum junction temperature of T<sub>J(MAX)</sub>=150° C. The SOA curve provides a single pulse rating.

APPLICATIONS OR USE AS CRITICAL COMPONENTS IN LIFE SUPPORT DEVICES OR SYSTEMS ARE NOT AUTHORIZED. AOS DOES NOT ASSUME ANY LIABILITY ARISING OUT OF SUCH APPLICATIONS OR USES OF ITS PRODUCTS. AOS RESERVES THE RIGHT TO IMPROVE PRODUCT DESIGN,FUNCTIONS AND RELIABILITY WITHOUT NOTICE.

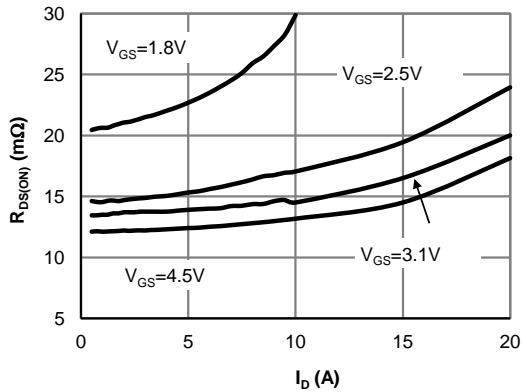
**TYPICAL ELECTRICAL AND THERMAL CHARACTERISTICS**



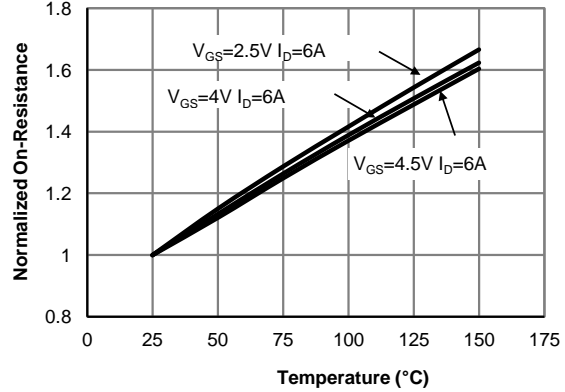
**Fig 1: On-Region Characteristics (Note E)**



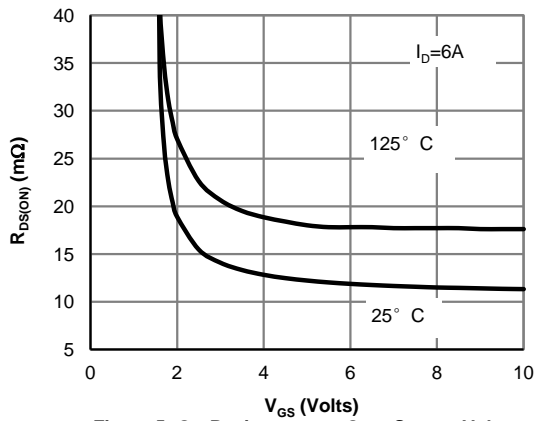
**Figure 2: Transfer Characteristics (Note E)**



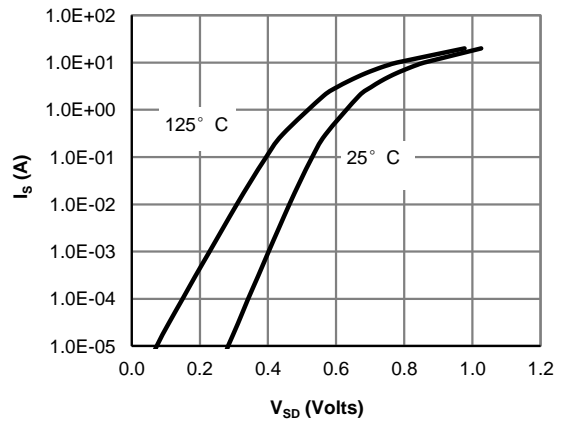
**Figure 3: On-Resistance vs. Drain Current and Gate Voltage (Note E)**



**Figure 4: On-Resistance vs. Junction Temperature (Note E)**

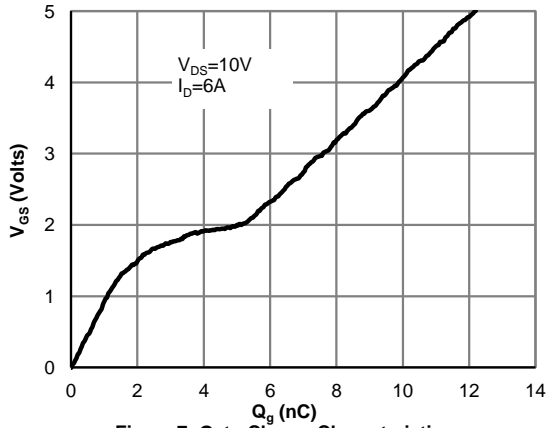


**Figure 5: On-Resistance vs. Gate-Source Voltage (Note E)**

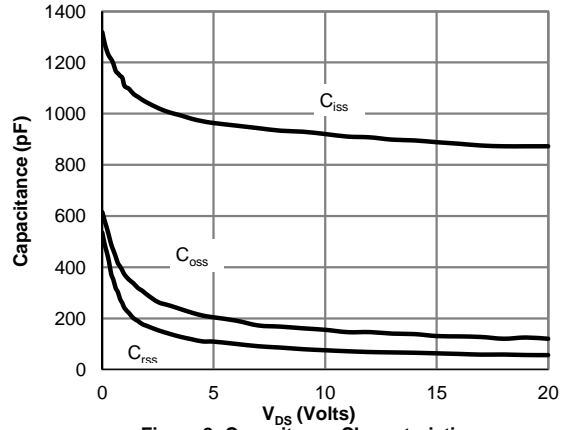


**Figure 6: Body-Diode Characteristics (Note E)**

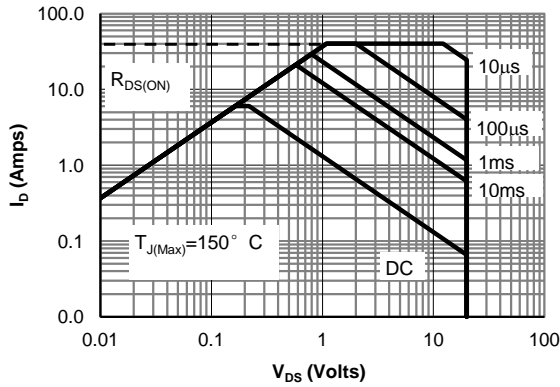
**TYPICAL ELECTRICAL AND THERMAL CHARACTERISTICS**



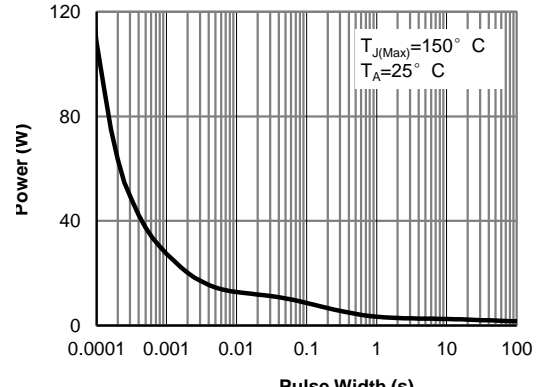
**Figure 7: Gate-Charge Characteristics**



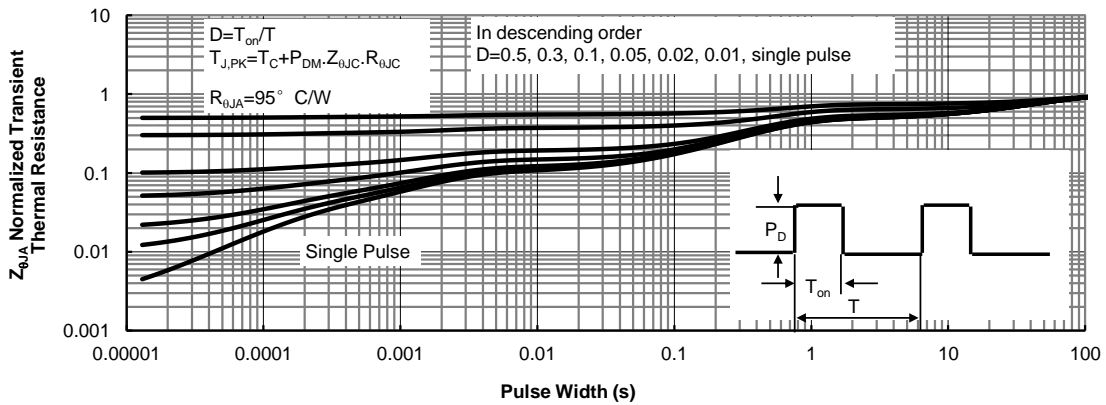
**Figure 8: Capacitance Characteristics**



**Figure 9: Maximum Forward Biased Safe Operating Area (Note F)**

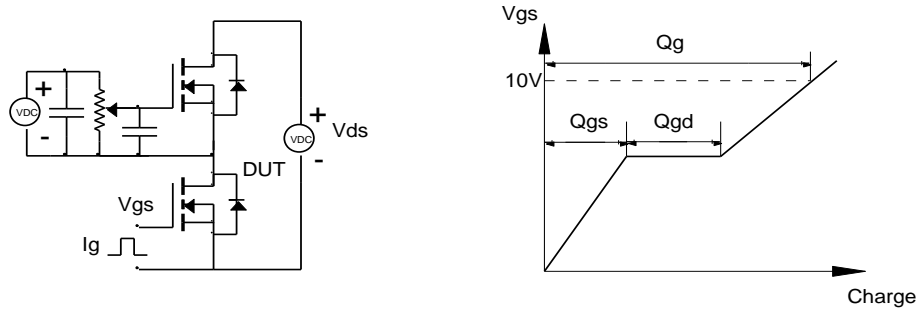


**Figure 10: Single Pulse Power Rating Junction-to-Case (Note F)**

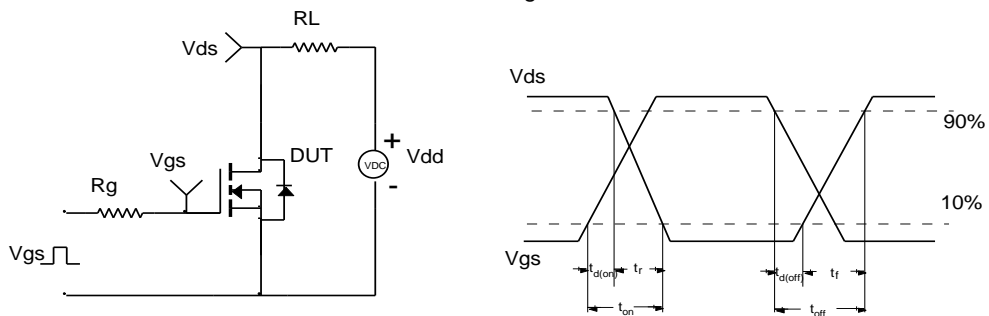


**Figure 11: Normalized Maximum Transient Thermal Impedance (Note F)**

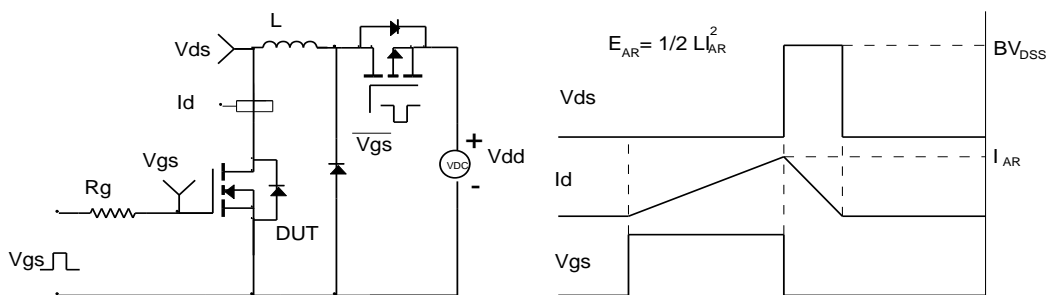
**Gate Charge Test Circuit & Waveform**



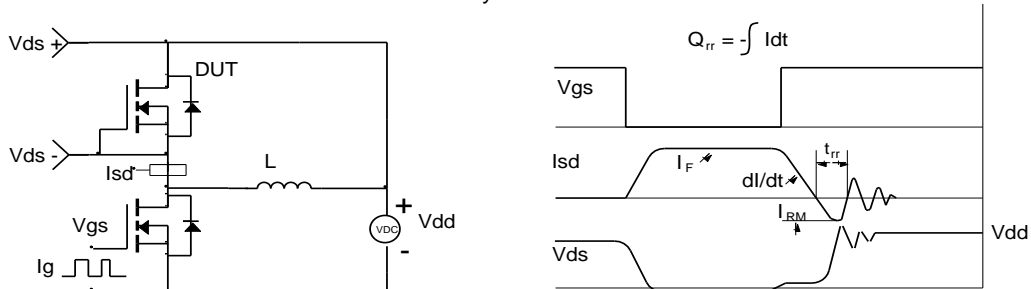
**Resistive Switching Test Circuit & Waveforms**



**Unclamped Inductive Switching (UIS) Test Circuit & Waveforms**



**Diode Recovery Test Circuit & Waveforms**



单击下面可查看定价，库存，交付和生命周期等信息

[>>AOS\(万国半导体\)](#)