

### General Description

- Trench Power AlphaSGT™ technology
- Low  $R_{DS(ON)}$
- Logic Level Driving
- Excellent Gate Charge x  $R_{DS(ON)}$  Product (FOM)
- RoHS and Halogen-Free Compliant

### Applications

- High Frequency Switching and Synchronous Rectification

### Product Summary

$V_{DS}$	100V
$I_D$ (at $V_{GS}=10V$ )	34A
$R_{DS(ON)}$ (at $V_{GS}=10V$ )	< 11.6m $\Omega$
$R_{DS(ON)}$ (at $V_{GS}=4.5V$ )	< 15.1m $\Omega$

100% UIS Tested  
 100% Rg Tested

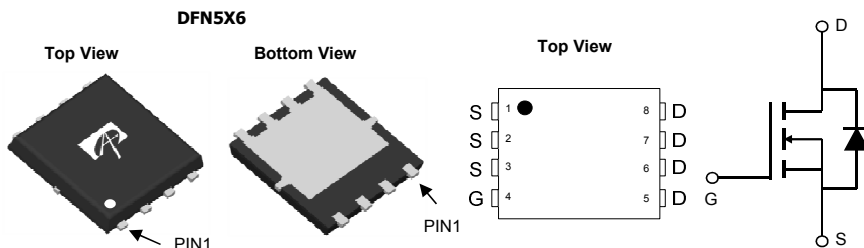

Orderable Part Number	Package Type	Form	Minimum Order Quantity
AON6224A	DFN 5x6	Tape & Reel	3000

### Absolute Maximum Ratings $T_A=25^\circ\text{C}$ unless otherwise noted

Parameter	Symbol	Maximum	Units
Drain-Source Voltage	$V_{DS}$	100	V
Gate-Source Voltage	$V_{GS}$	$\pm 20$	V
Continuous Drain Current <sup>G</sup>	$T_C=25^\circ\text{C}$	34	A
	$T_C=100^\circ\text{C}$	31	
Pulsed Drain Current <sup>C</sup>	$I_{DM}$	120	
Continuous Drain Current	$T_A=25^\circ\text{C}$	16	A
	$T_A=70^\circ\text{C}$	13	
Avalanche Current <sup>C</sup>	$I_{AS}$	25	A
Avalanche energy L=0.1mH <sup>C</sup>	$E_{AS}$	31	mJ
Power Dissipation <sup>B</sup>	$T_C=25^\circ\text{C}$	56.5	W
	$T_C=100^\circ\text{C}$	22.5	
Power Dissipation <sup>A</sup>	$T_A=25^\circ\text{C}$	6.2	W
	$T_A=70^\circ\text{C}$	4.0	
Junction and Storage Temperature Range	$T_J, T_{STG}$	-55 to 150	$^\circ\text{C}$

### Thermal Characteristics

Parameter	Symbol	Typ	Max	Units
Maximum Junction-to-Ambient <sup>A</sup> $t \leq 10s$	$R_{\theta JA}$	15	20	$^\circ\text{C}/\text{W}$
Maximum Junction-to-Ambient <sup>A,D</sup> Steady-State		40	50	$^\circ\text{C}/\text{W}$
Maximum Junction-to-Case Steady-State	$R_{\theta JC}$	1.8	2.2	$^\circ\text{C}/\text{W}$

Electrical Characteristics ( $T_J=25^\circ\text{C}$  unless otherwise noted)

Symbol	Parameter	Conditions	Min	Typ	Max	Units
<b>STATIC PARAMETERS</b>						
$BV_{DSS}$	Drain-Source Breakdown Voltage	$I_D=250\mu\text{A}$ , $V_{GS}=0\text{V}$	100			V
$I_{DSS}$	Zero Gate Voltage Drain Current	$V_{DS}=100\text{V}$ , $V_{GS}=0\text{V}$ $T_J=55^\circ\text{C}$			1 5	$\mu\text{A}$
$I_{GSS}$	Gate-Body leakage current	$V_{DS}=0\text{V}$ , $V_{GS}=\pm 20\text{V}$			$\pm 100$	nA
$V_{GS(th)}$	Gate Threshold Voltage	$V_{DS}=V_{GS}$ , $I_D=250\mu\text{A}$	1.5	2.0	2.5	V
$R_{DS(on)}$	Static Drain-Source On-Resistance	$V_{GS}=10\text{V}$ , $I_D=20\text{A}$ $T_J=125^\circ\text{C}$		9.6	11.6	m $\Omega$
		$V_{GS}=4.5\text{V}$ , $I_D=20\text{A}$		17.6	21.6	
$g_{FS}$	Forward Transconductance	$V_{DS}=5\text{V}$ , $I_D=20\text{A}$		67		S
$V_{SD}$	Diode Forward Voltage	$I_S=1\text{A}$ , $V_{GS}=0\text{V}$		0.7	1	V
$I_S$	Maximum Body-Diode Continuous Current <sup>G</sup>				34	A
<b>DYNAMIC PARAMETERS</b>						
$C_{iss}$	Input Capacitance	$V_{GS}=0\text{V}$ , $V_{DS}=50\text{V}$ , $f=1\text{MHz}$		2305		pF
$C_{oss}$	Output Capacitance			180		pF
$C_{riss}$	Reverse Transfer Capacitance			11.5		pF
$R_g$	Gate resistance	$f=1\text{MHz}$	0.2	0.5	1.0	$\Omega$
<b>SWITCHING PARAMETERS</b>						
$Q_g(10\text{V})$	Total Gate Charge	$V_{GS}=10\text{V}$ , $V_{DS}=50\text{V}$ , $I_D=20\text{A}$		32.5	50	nC
$Q_g(4.5\text{V})$	Total Gate Charge			15.5	25	nC
$Q_{gs}$	Gate Source Charge			6.5		nC
$Q_{gd}$	Gate Drain Charge			5		nC
$Q_{oss}$	Output Charge	$V_{GS}=0\text{V}$ , $V_{DS}=50\text{V}$		30		nC
$t_{D(on)}$	Turn-On DelayTime	$V_{GS}=10\text{V}$ , $V_{DS}=50\text{V}$ , $R_L=2.5\Omega$ , $R_{GEN}=3\Omega$		7		ns
$t_r$	Turn-On Rise Time			3		ns
$t_{D(off)}$	Turn-Off DelayTime			27		ns
$t_f$	Turn-Off Fall Time			4		ns
$t_{rr}$	Body Diode Reverse Recovery Time	$I_F=20\text{A}$ , $di/dt=500\text{A}/\mu\text{s}$		29.5		ns
$Q_{rr}$	Body Diode Reverse Recovery Charge	$I_F=20\text{A}$ , $di/dt=500\text{A}/\mu\text{s}$		160		nC

A. The value of  $R_{\theta JA}$  is measured with the device mounted on 1in<sup>2</sup> FR-4 board with 2oz. Copper, in a still air environment with  $T_A=25^\circ\text{C}$ . The Power dissipation  $P_{DSM}$  is based on  $R_{\theta JA}$   $t \leq 10\text{s}$  and the maximum allowed junction temperature of  $150^\circ\text{C}$ . The value in any given application depends on the user's specific board design.

B. The power dissipation  $P_D$  is based on  $T_{J(MAX)}=150^\circ\text{C}$ , using junction-to-case thermal resistance, and is more useful in setting the upper dissipation limit for cases where additional heatsinking is used.

C. Single pulse width limited by junction temperature  $T_{J(MAX)}=150^\circ\text{C}$ .

D. The  $R_{\theta JA}$  is the sum of the thermal impedance from junction to case  $R_{\theta JC}$  and case to ambient.

E. The static characteristics in Figures 1 to 6 are obtained using  $<300\mu\text{s}$  pulses, duty cycle 0.5% max.

F. These curves are based on the junction-to-case thermal impedance which is measured with the device mounted to a large heatsink, assuming a maximum junction temperature of  $T_{J(MAX)}=150^\circ\text{C}$ . The SOA curve provides a single pulse rating.

G. The maximum current rating is package limited.

H. These tests are performed with the device mounted on 1 in<sup>2</sup> FR-4 board with 2oz. Copper, in a still air environment with  $T_A=25^\circ\text{C}$ .

APPLICATIONS OR USE AS CRITICAL COMPONENTS IN LIFE SUPPORT DEVICES OR SYSTEMS ARE NOT AUTHORIZED. AOS DOES NOT ASSUME ANY LIABILITY ARISING OUT OF SUCH APPLICATIONS OR USES OF ITS PRODUCTS. AOS RESERVES THE RIGHT TO IMPROVE PRODUCT DESIGN, FUNCTIONS AND RELIABILITY WITHOUT NOTICE.

TYPICAL ELECTRICAL AND THERMAL CHARACTERISTICS

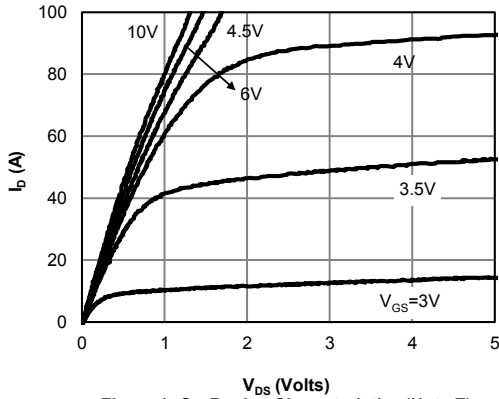

Figure 1: On-Region Characteristics (Note E)

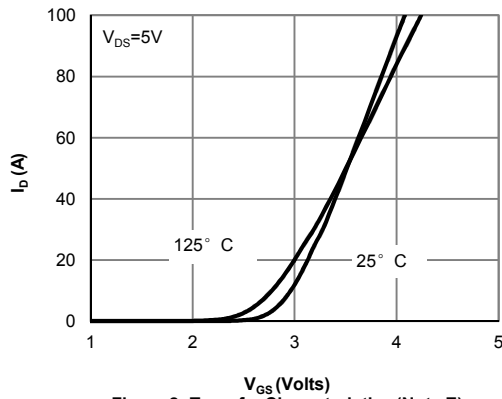

Figure 2: Transfer Characteristics (Note E)

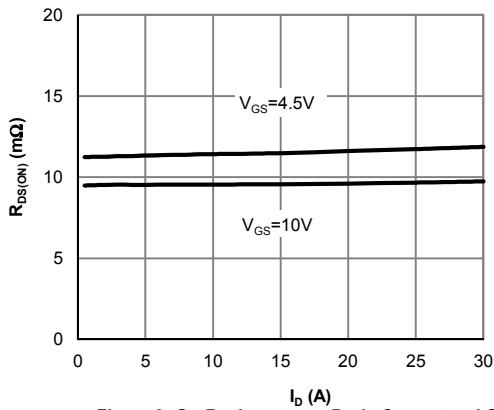

Figure 3: On-Resistance vs. Drain Current and Gate Voltage (Note E)

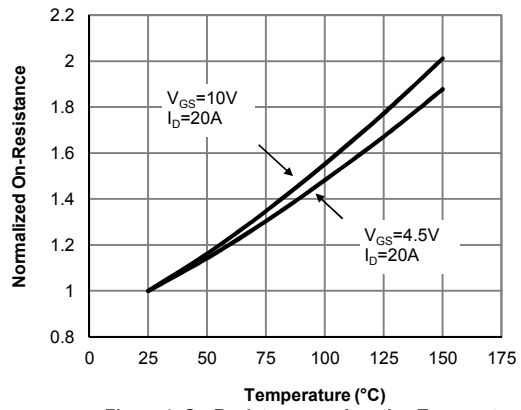

Figure 4: On-Resistance vs. Junction Temperature (Note E)

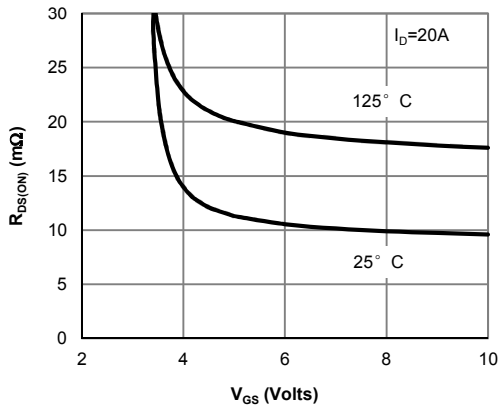

Figure 5: On-Resistance vs. Gate-Source Voltage (Note E)

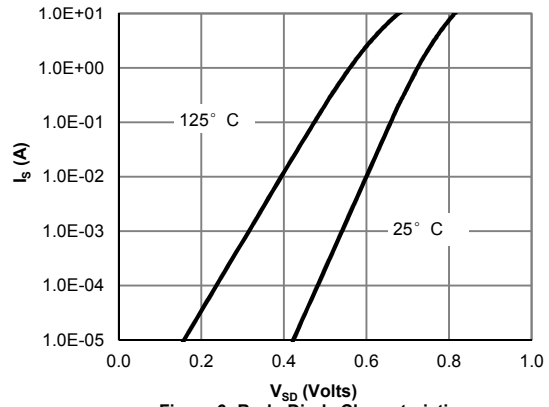

Figure 6: Body-Diode Characteristics (Note E)

TYPICAL ELECTRICAL AND THERMAL CHARACTERISTICS

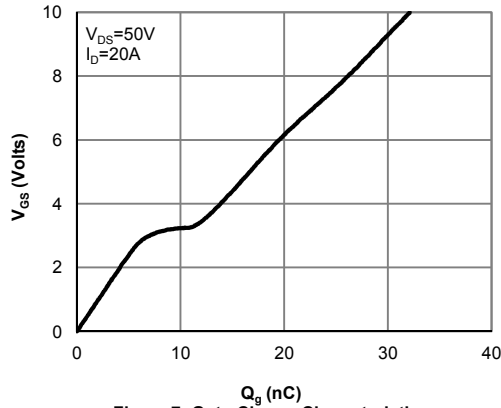

Figure 7: Gate-Charge Characteristics

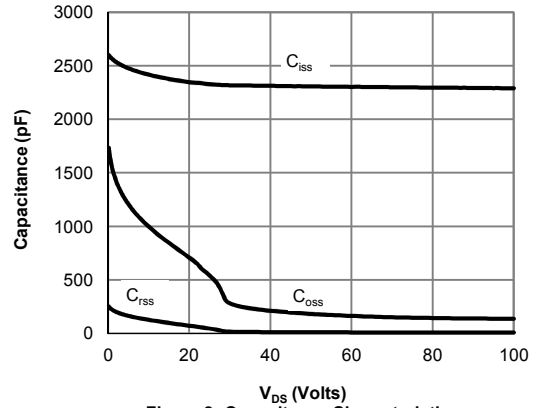

Figure 8: Capacitance Characteristics

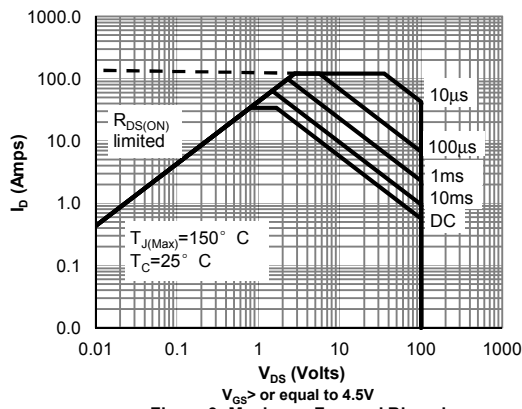

Figure 9: Maximum Forward Biased Safe Operating Area (Note F)

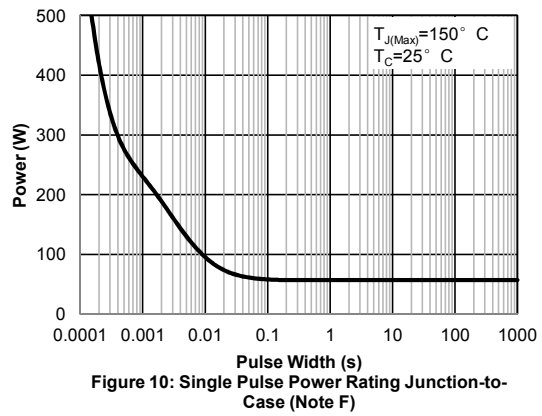

Figure 10: Single Pulse Power Rating Junction-to-Case (Note F)

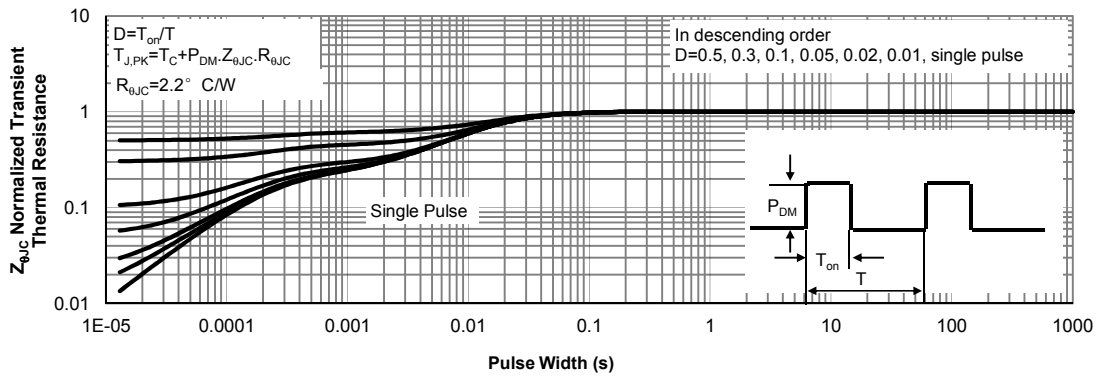

Figure 11: Normalized Maximum Transient Thermal Impedance (Note F)

TYPICAL ELECTRICAL AND THERMAL CHARACTERISTICS

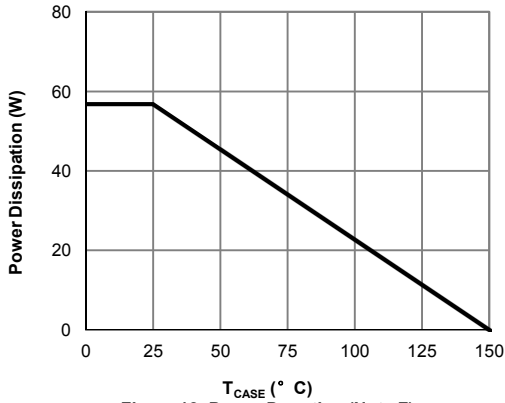

Figure 12: Power De-rating (Note F)

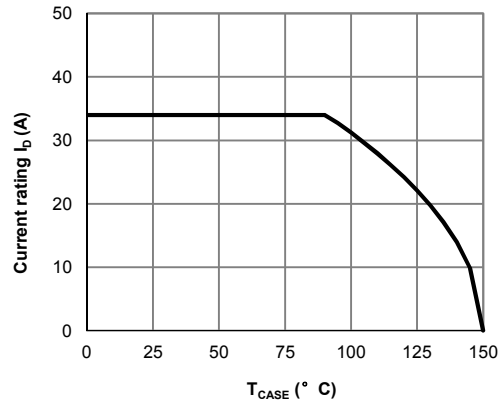

Figure 13: Current De-rating (Note F)

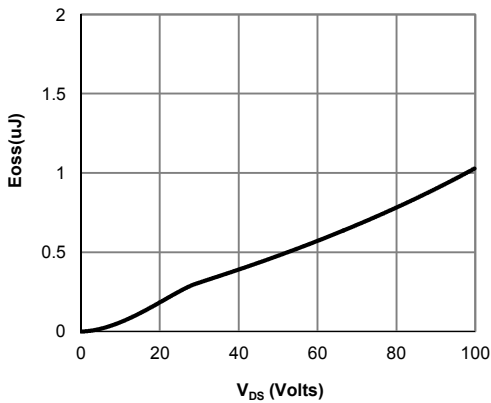

Figure 14: Coss stored Energy

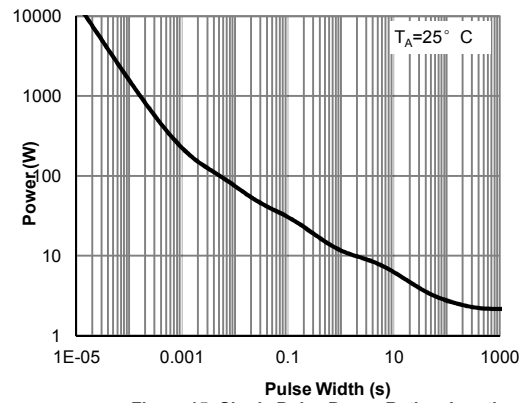

Figure 15: Single Pulse Power Rating Junction-to-Ambient (Note H)

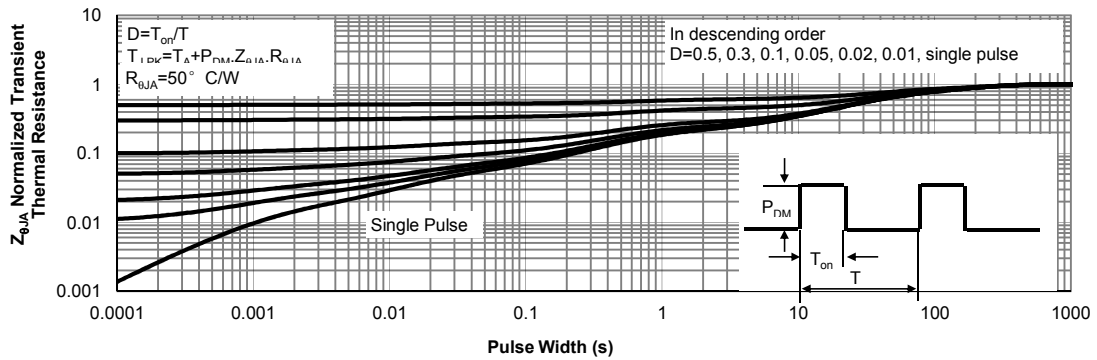

Figure 16: Normalized Maximum Transient Thermal Impedance (Note H)

Figure A: Gate Charge Test Circuit & Waveforms

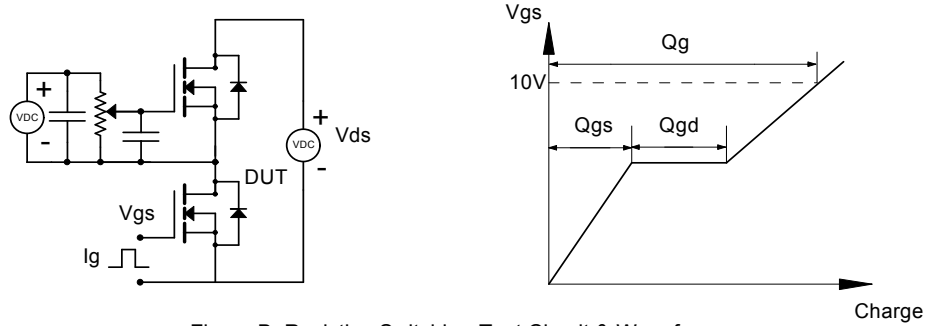

Figure B: Resistive Switching Test Circuit & Waveforms

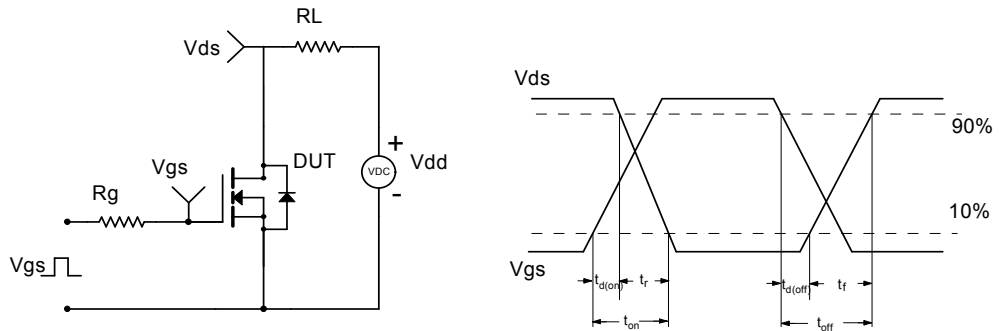

Figure C: Unclamped Inductive Switching (UIS) Test Circuit & Waveforms

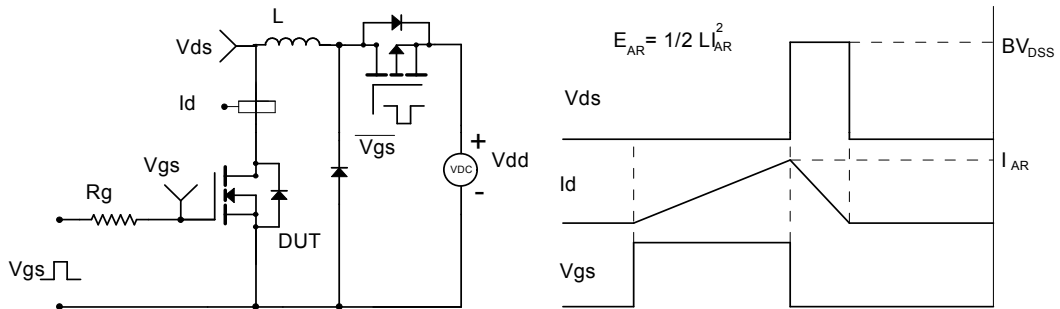
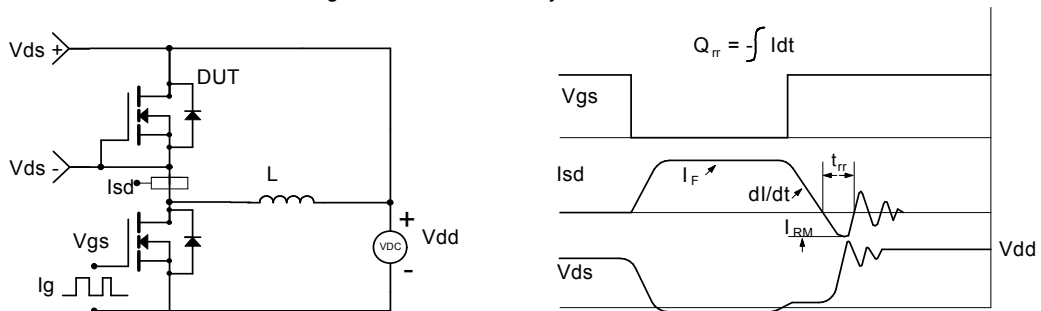

Figure D: Diode Recovery Test Circuit & Waveforms



单击下面可查看定价，库存，交付和生命周期等信息

[>>AOS\(万国半导体\)](#)