

General Description

- Proprietary α MOS5™ technology
- Low $R_{DS(ON)}$
- Optimized switching parameters for better EMI performance
- Enhanced body diode for robustness and fast reverse recovery

Applications

- PFC and PWM stages (Flyback, LLC) of Adapter, PC Silverbox, Server, Gaming Power Supply, Industrial, TV, Lighting

Product Summary

$V_{DS} @ T_{j,max}$	800V
I_{DM}	28A
$R_{DS(ON),max}$	< 0.78 Ω
$Q_{g,typ}$	11.5nC
$E_{oss} @ 400V$	1.4 μ J

100% UIS Tested
 100% R_g Tested

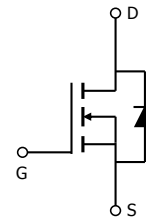
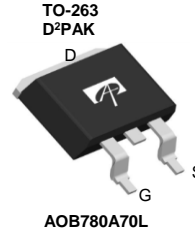
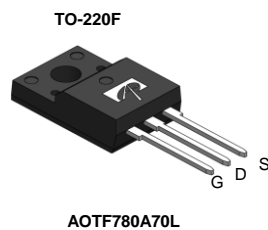
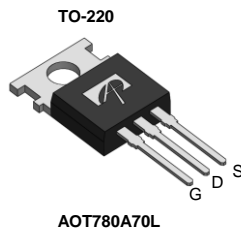

Orderable Part Number	Package Type	Form	Minimum Order Quantity
AOTF780A70L	TO220F	Tube	1000
AOT780A70L	TO220	Tube	1000
AOB780A70L	TO263	Tape&Reel	800

Absolute Maximum Ratings $T_A=25^\circ\text{C}$ unless otherwise noted

Parameter	Symbol	AOT(B)780A70L	AOTF780A70L	Units
Drain-Source Voltage	V_{DS}	700		V
Gate-Source Voltage	V_{GS}	± 20		V
Gate-Source Voltage (dynamic) AC($f > 1\text{Hz}$)	V_{GS}	± 30		V
Continuous Drain Current	I_D	$T_C=25^\circ\text{C}$	7	7*
		$T_C=100^\circ\text{C}$	4.5	4.5*
Pulsed Drain Current ^C	I_{DM}	28		A
Avalanche Current ^C $L=1\text{mH}$	I_{AR}	1.7		A
Repetitive avalanche energy ^C	E_{AR}	1.5		mJ
Single pulsed avalanche energy ^G	E_{AS}	11		mJ
MOSFET dv/dt ruggedness	dv/dt	100		V/ns
Peak diode recovery dv/dt		20		
Power Dissipation ^B	P_D	$T_C=25^\circ\text{C}$	89	25
		Derate above 25°C	0.7	0.2
Junction and Storage Temperature Range	T_J, T_{STG}	-55 to 150		$^\circ\text{C}$
Maximum lead temperature for soldering purpose, 1/8" from case for 5 seconds	T_L	300		$^\circ\text{C}$

Thermal Characteristics

Parameter	Symbol	AOT(B)780A70L	AOTF780A70L	Units
Maximum Junction-to-Ambient ^{A,D}	$R_{\theta JA}$	65	65	$^\circ\text{C/W}$
Maximum Case-to-sink ^A	$R_{\theta CS}$	0.5	--	$^\circ\text{C/W}$
Maximum Junction-to-Case	$R_{\theta JC}$	1.4	5.0	$^\circ\text{C/W}$

* Drain current limited by maximum junction temperature.

Electrical Characteristics (T_J=25°C unless otherwise noted)

Symbol	Parameter	Conditions	Min	Typ	Max	Units	
STATIC PARAMETERS							
BV _{DSS}	Drain-Source Breakdown Voltage	I _D =250μA, V _{GS} =0V, T _J =25°C	700			V	
		I _D =250μA, V _{GS} =0V, T _J =150°C		800			
BV _{DSS} /ΔT _J	Breakdown Voltage Temperature Coefficient	I _D =250μA, V _{GS} =0V		0.56		V/°C	
I _{DSS}	Zero Gate Voltage Drain Current	V _{DS} =700V, V _{GS} =0V			1	μA	
		V _{DS} =560V, T _J =125°C			10		
I _{GSS}	Gate-Body leakage current	V _{DS} =0V, V _{GS} =±20V			±100	nA	
V _{GS(th)}	Gate Threshold Voltage	V _{DS} =5V, I _D =250μA	2.9	3.5	4.1	V	
R _{DS(ON)}	Static Drain-Source On-Resistance	V _{GS} =10V, I _D =1.4A		0.7	0.78	Ω	
g _{FS}	Forward Transconductance	V _{DS} =10V, I _D =1.4A		3		S	
V _{SD}	Diode Forward Voltage	I _S =1.4A, V _{GS} =0V		0.8	1.2	V	
I _S	Maximum Body-Diode Continuous Current				7	A	
I _{SM}	Maximum Body-Diode Pulsed Current ^C				28	A	
DYNAMIC PARAMETERS							
C _{iss}	Input Capacitance	V _{GS} =0V, V _{DS} =100V, f=1MHz		675		pF	
C _{oss}	Output Capacitance				18		pF
C _{o(er)}	Effective output capacitance, energy related ^H	V _{GS} =0V, V _{DS} =0 to 400V, f=1MHz		16.5		pF	
C _{o(tr)}	Effective output capacitance, time related ^I				72		pF
C _{rss}	Reverse Transfer Capacitance	V _{GS} =0V, V _{DS} =100V, f=1MHz		1.8		pF	
R _g	Gate resistance	f=1MHz		3.1		Ω	
SWITCHING PARAMETERS							
Q _g	Total Gate Charge	V _{GS} =10V, V _{DS} =480V, I _D =3.5A		11.5		nC	
Q _{gs}	Gate Source Charge				4.8		nC
Q _{gd}	Gate Drain Charge				2.8		nC
T _{d(on)}	Turn-On DelayTime	V _{GS} =10V, V _{DS} =400V, I _D =3.5A, R _G =5Ω		18		ns	
T _r	Turn-On Rise Time				9		ns
T _{d(off)}	Turn-Off DelayTime				30		ns
T _f	Turn-Off Fall Time				12		ns
T _{rr}	Body Diode Reverse Recovery Time				230		ns
I _{rm}	Peak Reverse Recovery Current	I _F =3.5A, di/dt=100A/μs, V _{DS} =400V		16.5		A	
Q _{rr}	Body Diode Reverse Recovery Charge			2.5		μC	

A. The value of R_{θJA} is measured with the device in a still air environment with T_A=25° C.

B. The power dissipation P_D is based on T_{J(MAX)}=150° C, using junction-to-case thermal resistance, and is more useful in setting the upper dissipation limit for cases where additional heatsinking is used.

C. Repetitive rating, pulse width limited by junction temperature T_{J(MAX)}=150° C, Ratings are based on low frequency and duty cycles to keep initial T_J=25° C.

D. The R_{θJA} is the sum of the thermal impedance from junction to case R_{θJC} and case to ambient.

E. The static characteristics in Figures 1 to 6 are obtained using <300μs pulses, duty cycle 0.5% max.

F. These curves are based on the junction-to-case thermal impedance which is measured with the device mounted to a large heatsink, assuming a maximum junction temperature of T_{J(MAX)}=150° C. The SOA curve provides a single pulse rating.

G. L=60mH, I_{AS}=0.6A, R_G=25Ω, Starting T_J=25° C.

H. C_{o(er)} is a fixed capacitance that gives the same stored energy as C_{oss} while V_{DS} is rising from 0 to 80% V_{(BR)DSS}.

I. C_{o(tr)} is a fixed capacitance that gives the same charging time as C_{oss} while V_{DS} is rising from 0 to 80% V_{(BR)DSS}.

APPLICATIONS OR USES AS CRITICAL COMPONENTS IN LIFE SUPPORT DEVICES OR SYSTEMS ARE NOT AUTHORIZED. AOS DOES NOT ASSUME ANY LIABILITY ARISING OUT OF SUCH APPLICATIONS OR USES OF ITS PRODUCTS. AOS RESERVES THE RIGHT TO MAKE CHANGES TO PRODUCT SPECIFICATIONS WITHOUT NOTICE. IT IS THE RESPONSIBILITY OF THE CUSTOMER TO EVALUATE SUITABILITY OF THE PRODUCT FOR THEIR INTENDED APPLICATION. CUSTOMER SHALL COMPLY WITH APPLICABLE LEGAL REQUIREMENTS, INCLUDING ALL APPLICABLE EXPORT CONTROL RULES, REGULATIONS AND LIMITATIONS.

AOS' products are provided subject to AOS' terms and conditions of sale which are set forth at:

http://www.aosmd.com/terms_and_conditions_of_sale

TYPICAL ELECTRICAL AND THERMAL CHARACTERISTICS

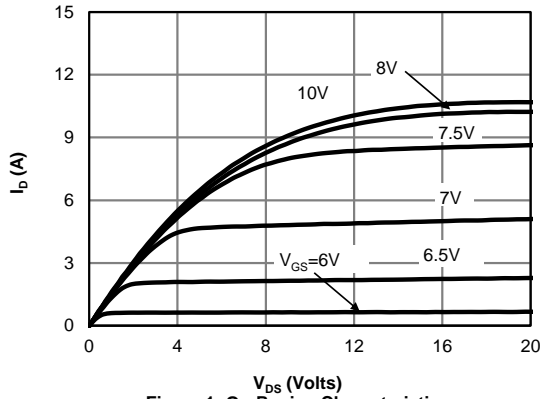

Figure 1: On-Region Characteristics

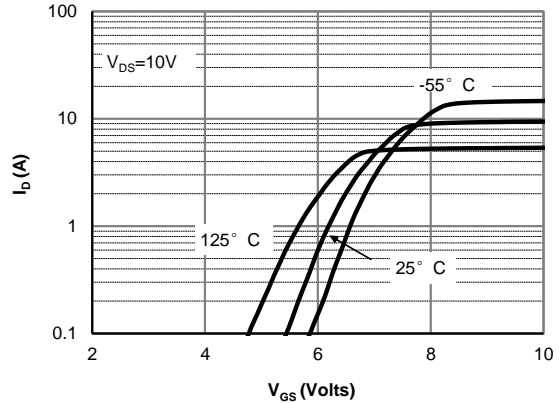

Figure 2: Transfer Characteristics

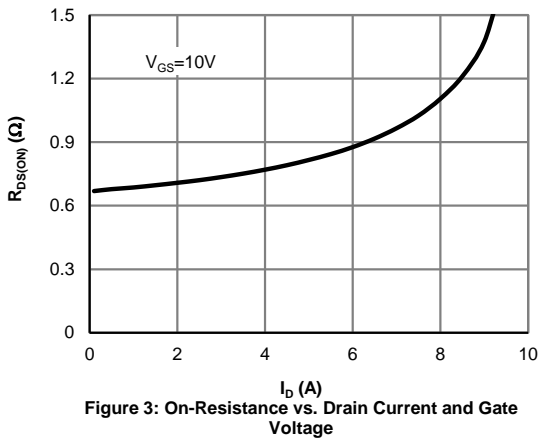

Figure 3: On-Resistance vs. Drain Current and Gate Voltage

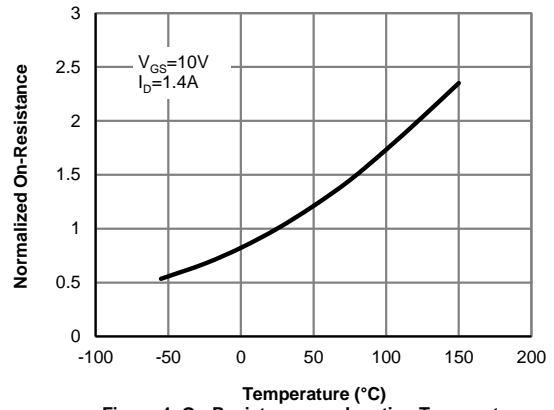

Figure 4: On-Resistance vs. Junction Temperature

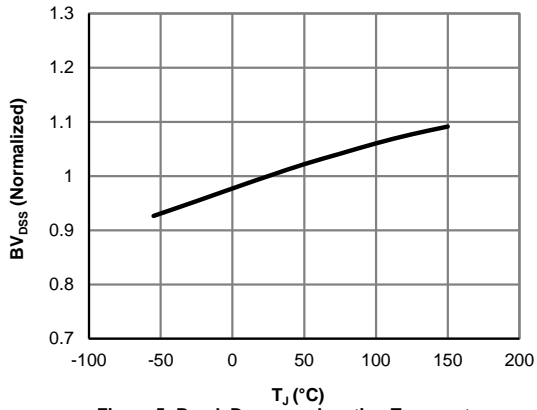

Figure 5: Break Down vs. Junction Temperature

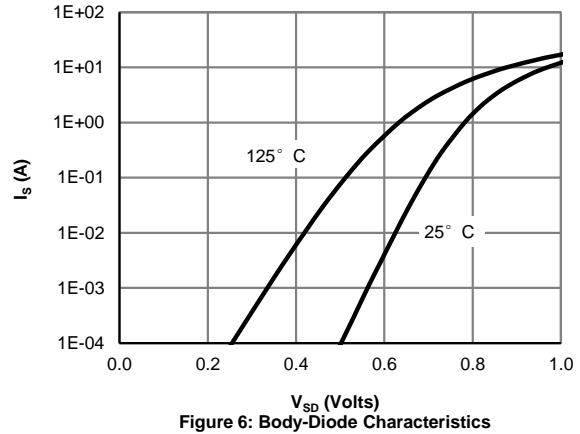

Figure 6: Body-Diode Characteristics

TYPICAL ELECTRICAL AND THERMAL CHARACTERISTICS

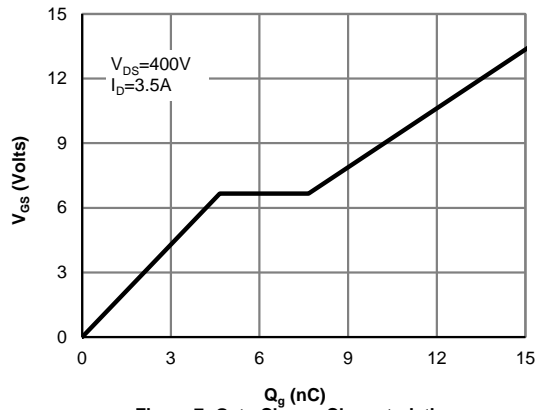

Figure 7: Gate-Charge Characteristics

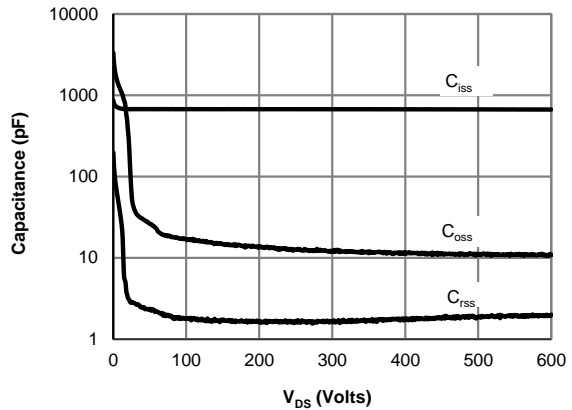

Figure 8: Capacitance Characteristics

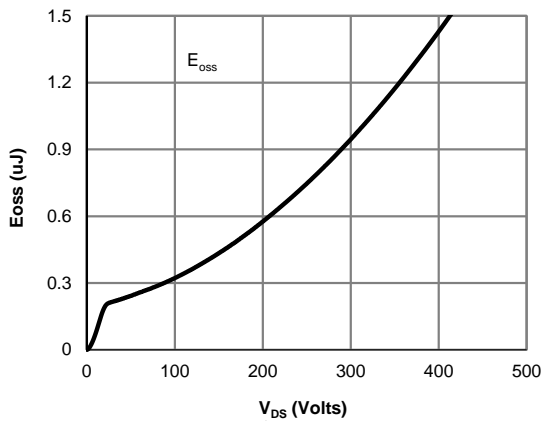

Figure 9: Coss stored Energy

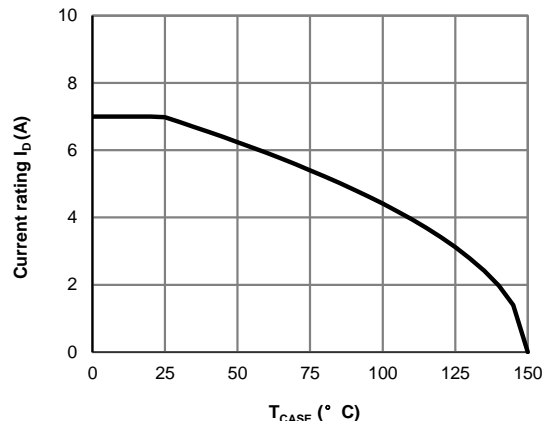

Figure 10: Current De-rating (Note F)

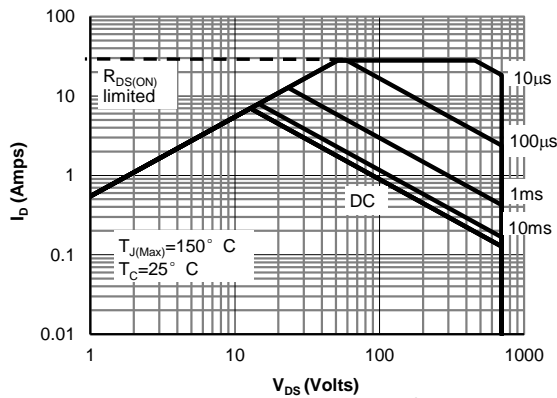

Figure 11: Maximum Forward Biased Safe Operating Area for AOT(B)780A70L (Note F)

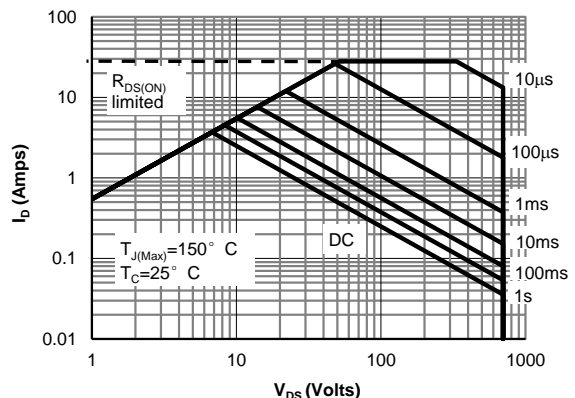

Figure 12: Maximum Forward Biased Safe Operating Area for AOTF780A70L (Note F)

TYPICAL ELECTRICAL AND THERMAL CHARACTERISTICS

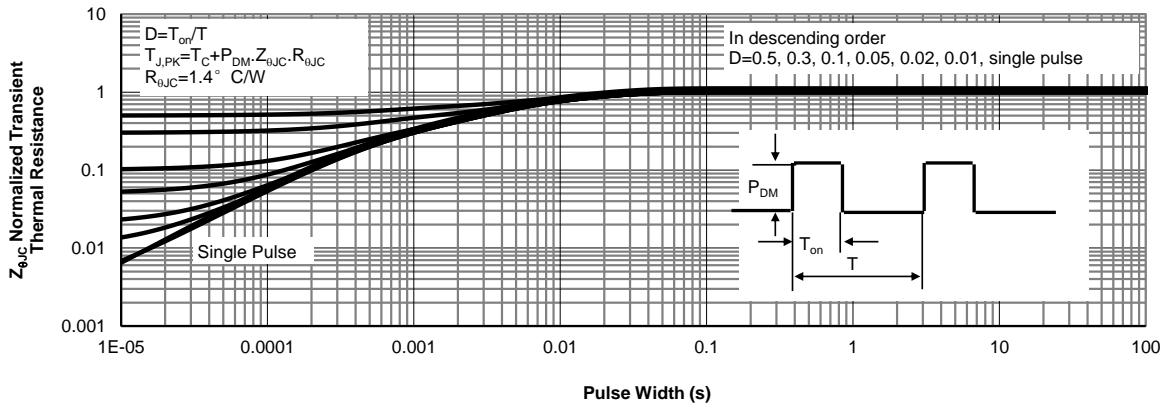

Figure 13: Normalized Maximum Transient Thermal Impedance for AOT(B)780A70L (Note F)

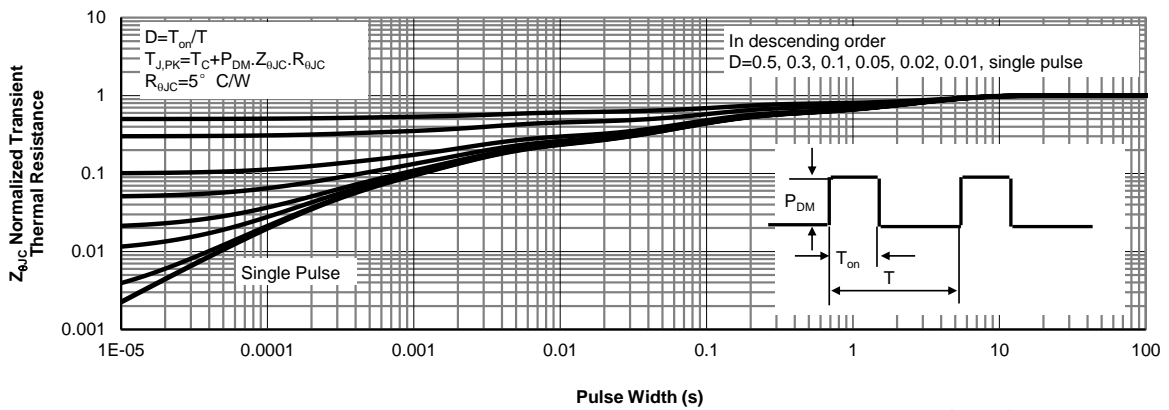
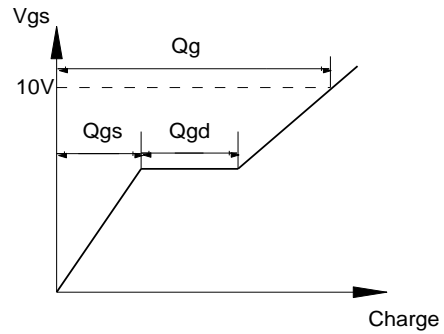
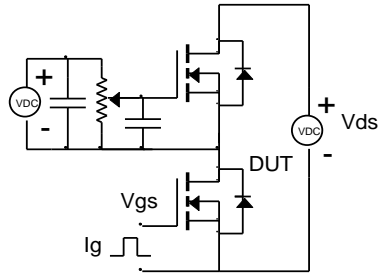
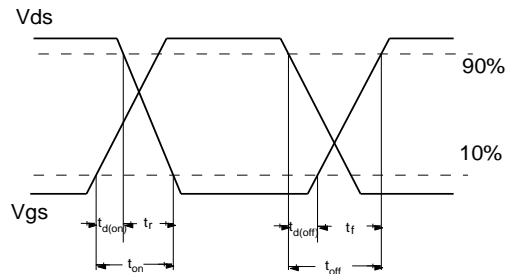
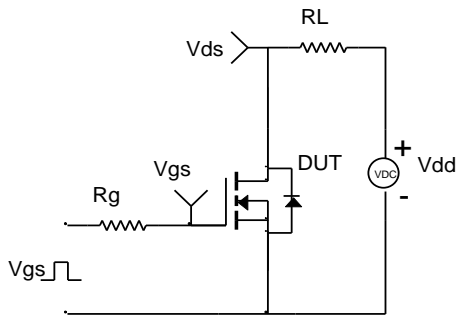

Figure 14: Normalized Maximum Transient Thermal Impedance for AOTF780A70L (Note F)

Gate Charge Test Circuit & Waveform



Resistive Switching Test Circuit & Waveforms



Unclamped Inductive Switching (UIS) Test Circuit & Waveforms

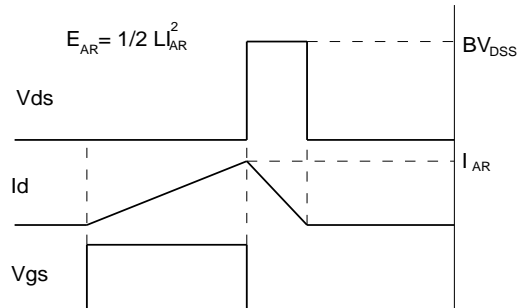
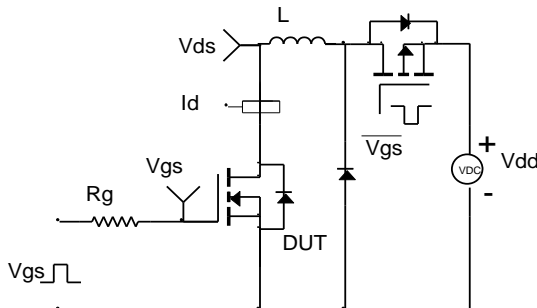

Diode Recovery Test Circuit & Waveforms

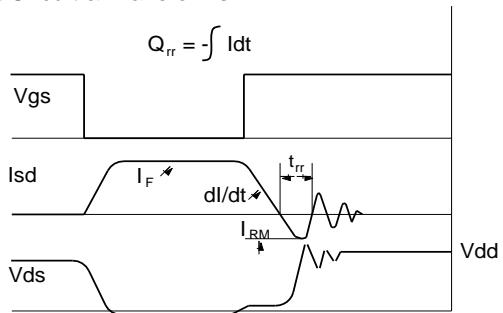
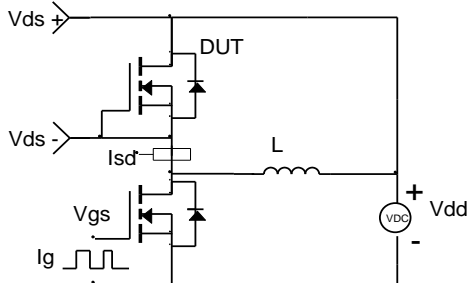

单击下面可查看定价，库存，交付和生命周期等信息

[>>AOS\(万代\)](#)