



General Description

The AOTF5N50FD has been fabricated using an advanced high voltage MOSFET process that is designed to deliver high levels of performance and robustness in popular AC-DC applications. By providing low $R_{DS(on)}$, C_{iss} and C_{rss} along with guaranteed avalanche capability this part can be adopted quickly into new and existing offline power supply designs.

For Halogen Free add "L" suffix to part number:
AOTF5N50FDL

Product Summary

V_{DS}	600V@150°C
I_D (at $V_{GS}=10V$)	5A
$R_{DS(ON)}$ (at $V_{GS}=10V$)	<1.8Ω

100% UIS Tested
100% R_g Tested



Top View
TO-220F

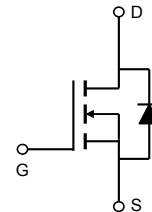
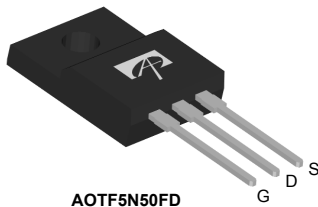

Absolute Maximum Ratings $T_A=25^\circ C$ unless otherwise noted

Parameter	Symbol	AOTF5N50FD	Units
Drain-Source Voltage	V_{DS}	500	V
Gate-Source Voltage	V_{GS}	±30	V
Continuous Drain Current	I_D	$T_C=25^\circ C$	5*
		$T_C=100^\circ C$	3*
Pulsed Drain Current ^C	I_{DM}	13	A
Avalanche Current ^C	I_{AR}	2.3	A
Repetitive avalanche energy ^C	E_{AR}	79	mJ
Single pulsed avalanche energy ^G	E_{AS}	158	mJ
Peak diode recovery dv/dt	dv/dt	5	V/ns
Power Dissipation ^B	P_D	$T_C=25^\circ C$	35
		Derate above 25°C	0.3
Junction and Storage Temperature Range	T_J, T_{STG}	-55 to 150	°C
Maximum lead temperature for soldering purpose, 1/8" from case for 5 seconds	T_L	300	°C

Thermal Characteristics

Parameter	Symbol	AOTF5N50FD	Units
Maximum Junction-to-Ambient ^{A,D}	$R_{\theta JA}$	65	°C/W
Maximum Junction-to-Case	$R_{\theta JC}$	3.6	°C/W

* Drain current limited by maximum junction temperature.

Electrical Characteristics (T_J=25°C unless otherwise noted)

Symbol	Parameter	Conditions	Min	Typ	Max	Units
STATIC PARAMETERS						
BV _{DSS}	Drain-Source Breakdown Voltage	I _D =10mA, V _{GS} =0V, T _J =25°C	500			V
		I _D =10mA, V _{GS} =0V, T _J =150°C		600		
BV _{DSS} /ΔT _J	Breakdown Voltage Temperature Coefficient	I _D =10mA, V _{GS} =0V		0.56		V/°C
I _{DSS}	Zero Gate Voltage Drain Current	V _{DS} =500V, V _{GS} =0V			10	μA
		V _{DS} =400V, T _J =125°C			100	
I _{GSS}	Gate-Body leakage current	V _{DS} =0V, V _{GS} =±30V			±100	nA
V _{GS(th)}	Gate Threshold Voltage	V _{DS} =5V, I _D =250μA	2.5	3.5	4.2	V
R _{DS(ON)}	Static Drain-Source On-Resistance	V _{GS} =10V, I _D =2.5A		1.5	1.8	Ω
g _{FS}	Forward Transconductance	V _{DS} =40V, I _D =2.5A		4		S
V _{SD}	Diode Forward Voltage	I _S =5A, V _{GS} =0V		0.93	1.6	V
I _S	Maximum Body-Diode Continuous Current				5	A
I _{SM}	Maximum Body-Diode Pulsed Current				13	A
DYNAMIC PARAMETERS						
C _{iss}	Input Capacitance	V _{GS} =0V, V _{DS} =25V, f=1MHz	350	440	530	pF
C _{oss}	Output Capacitance		35	50	65	pF
C _{rss}	Reverse Transfer Capacitance		2.5	4.5	6.5	pF
R _g	Gate resistance	V _{GS} =0V, V _{DS} =0V, f=1MHz	1.7	3.4	5.2	Ω
SWITCHING PARAMETERS						
Q _g	Total Gate Charge	V _{GS} =10V, V _{DS} =400V, I _D =5A	8	11	15	nC
Q _{gs}	Gate Source Charge			2.7		nC
Q _{gd}	Gate Drain Charge			3.8		nC
t _{D(on)}	Turn-On DelayTime	V _{GS} =10V, V _{DS} =250V, I _D =5A, R _G =25Ω		18		ns
t _r	Turn-On Rise Time			33		ns
t _{D(off)}	Turn-Off DelayTime			31		ns
t _f	Turn-Off Fall Time			26		ns
t _{rr}	Body Diode Reverse Recovery Time	I _F =5A, dI/dt=100A/μs, V _{DS} =100V		87	145	ns
Q _{rr}	Body Diode Reverse Recovery Charge	I _F =5A, dI/dt=100A/μs, V _{DS} =100V		0.2	0.4	μC

A. The value of R_{θJA} is measured with the device in a still air environment with T_A=25°C.

B. The power dissipation P_D is based on T_{J(MAX)}=150°C, using junction-to-case thermal resistance, and is more useful in setting the upper dissipation limit for cases where additional heatsinking is used.

C. Repetitive rating, pulse width limited by junction temperature T_{J(MAX)}=150°C, Ratings are based on low frequency and duty cycles to keep initial T_J=25°C.

D. The R_{θJA} is the sum of the thermal impedance from junction to case R_{θJC} and case to ambient.

E. The static characteristics in Figures 1 to 6 are obtained using <300 μs pulses, duty cycle 0.5% max.

F. These curves are based on the junction-to-case thermal impedance which is measured with the device mounted to a large heatsink, assuming a maximum junction temperature of T_{J(MAX)}=150°C. The SOA curve provides a single pulse rating.

G. L=60mH, I_{AS}=2.3A, V_{DD}=150V, R_G=25Ω, Starting T_J=25°C

THIS PRODUCT HAS BEEN DESIGNED AND QUALIFIED FOR THE CONSUMER MARKET. APPLICATIONS OR USES AS CRITICAL COMPONENTS IN LIFE SUPPORT DEVICES OR SYSTEMS ARE NOT AUTHORIZED. AOS DOES NOT ASSUME ANY LIABILITY ARISING OUT OF SUCH APPLICATIONS OR USES OF ITS PRODUCTS. AOS RESERVES THE RIGHT TO IMPROVE PRODUCT DESIGN, FUNCTIONS AND RELIABILITY WITHOUT NOTICE.

TYPICAL ELECTRICAL AND THERMAL CHARACTERISTICS

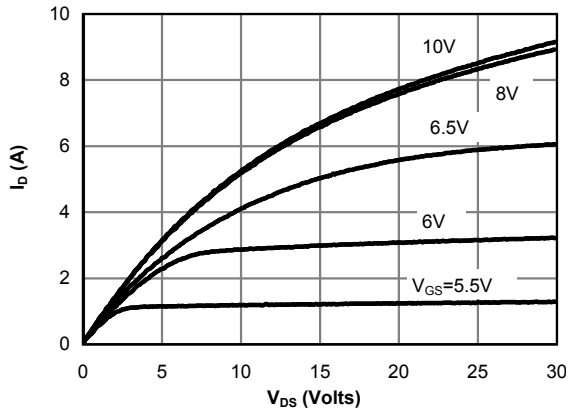

Fig 1: On-Region Characteristics

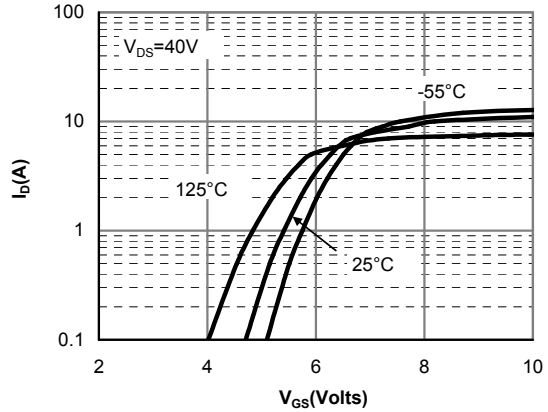

Figure 2: Transfer Characteristics

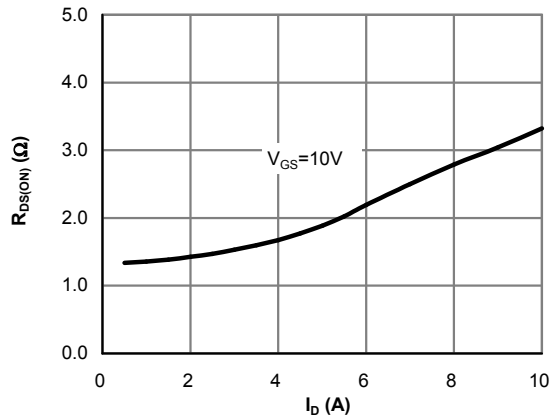

Figure 3: On-Resistance vs. Drain Current and Gate Voltage

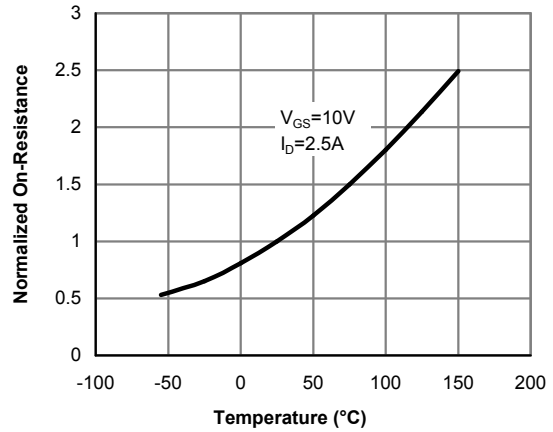

Figure 4: On-Resistance vs. Junction Temperature

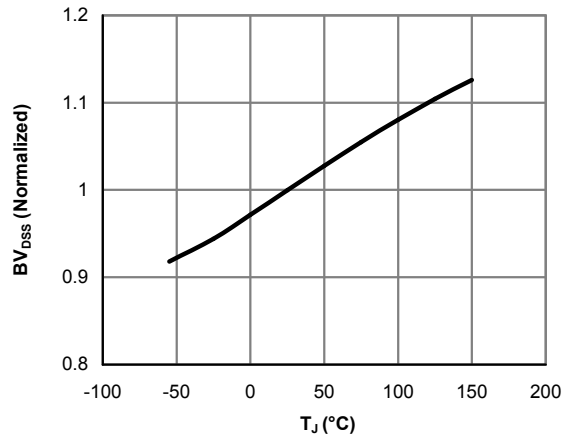

Figure 5: Break Down vs. Junction Temperature

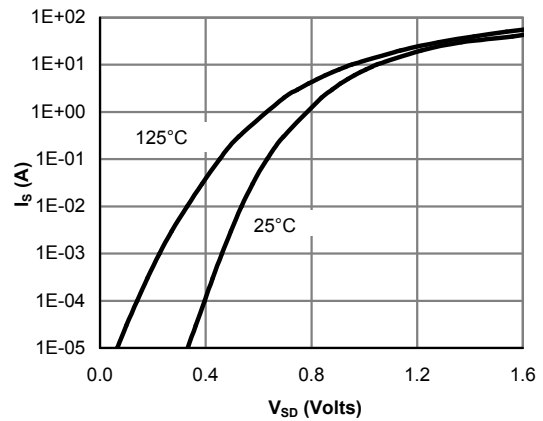

Figure 6: Body-Diode Characteristics (Note E)

TYPICAL ELECTRICAL AND THERMAL CHARACTERISTICS

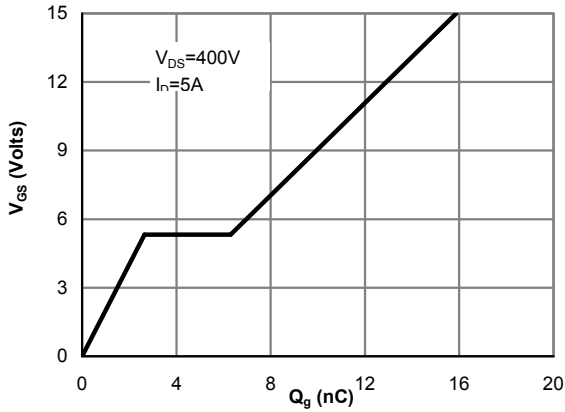

Figure 7: Gate-Charge Characteristics

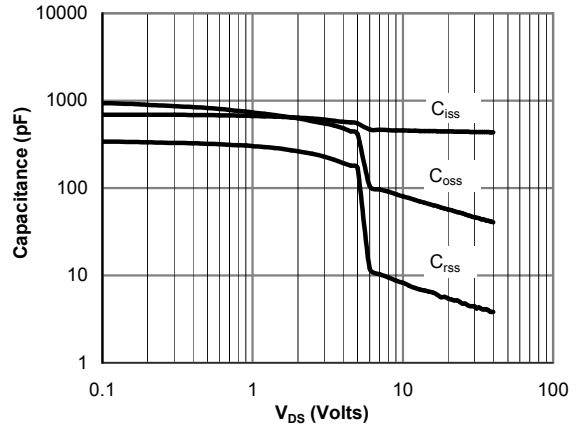

Figure 8: Capacitance Characteristics

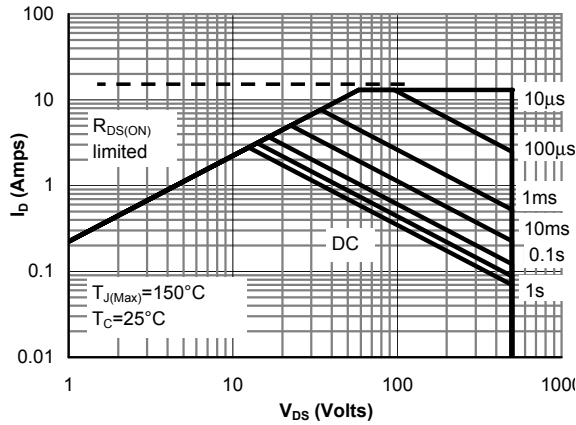

Figure 9: Maximum Forward Biased Safe Operating Area for AOTF5N50FD (Note F)

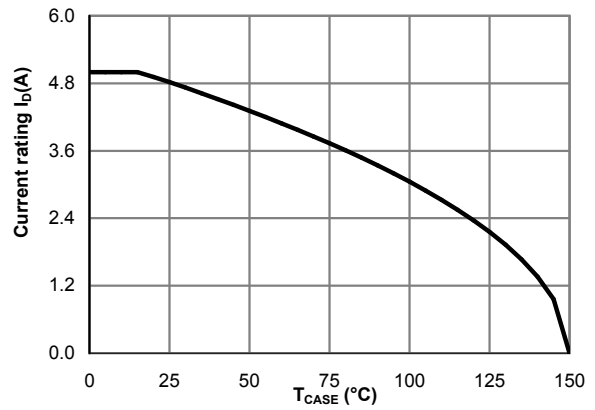

Figure 10: Current De-rating (Note B)

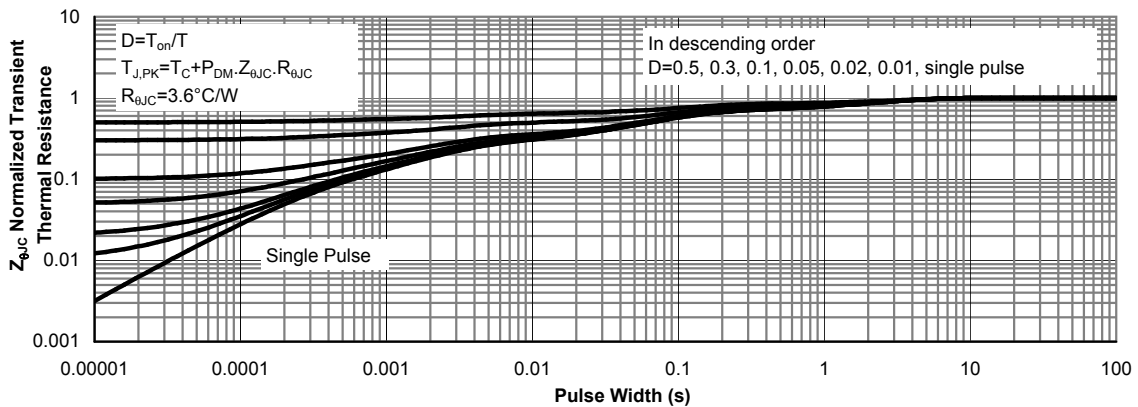

Figure 11: Normalized Maximum Transient Thermal Impedance for AOTF5N50FD (Note F)

TYPICAL ELECTRICAL AND THERMAL CHARACTERISTICS

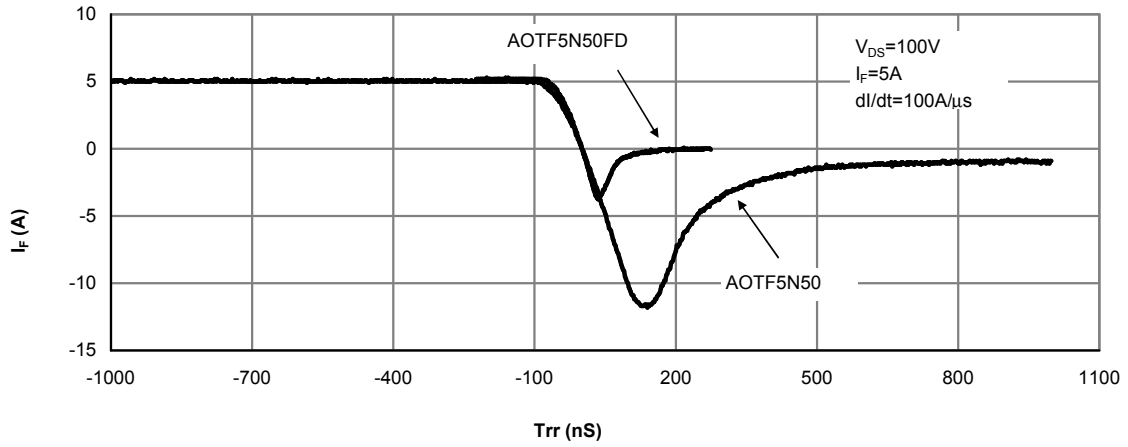
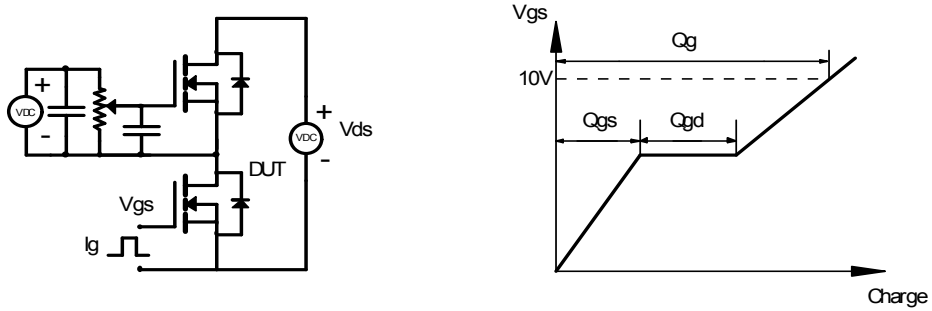
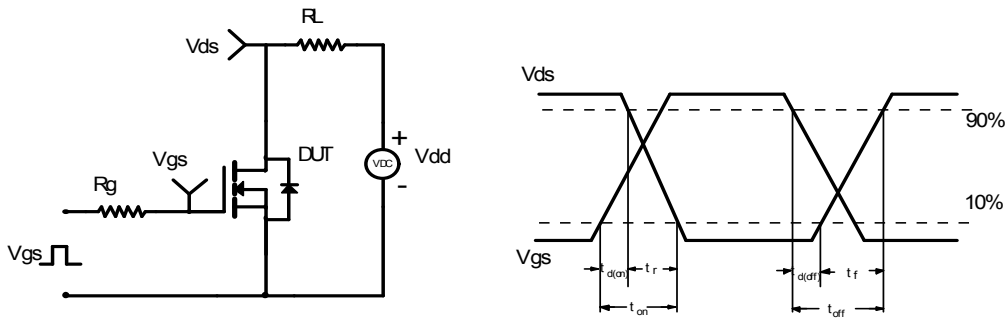

Figure 12: Diode Recovery Characteristics

Gate Charge Test Circuit & Waveform



Resistive Switching Test Circuit & Waveforms



Unclamped Inductive Switching (UIS) Test Circuit & Waveforms

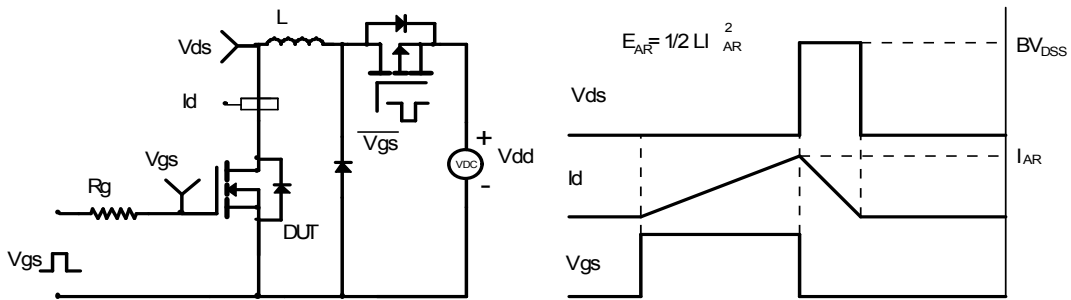

Diode Recovery Test Circuit & Waveforms

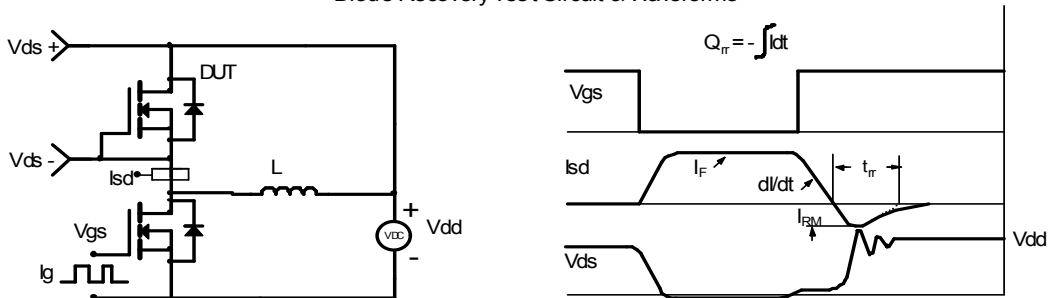

单击下面可查看定价，库存，交付和生命周期等信息

[>>AOS\(万国半导体\)](#)