

General Description

- Trench Power AlphaSGT™ technology
- Low $R_{DS(ON)}$
- Low Gate Charge
- Optimized for fast-switching applications
- RoHS and Halogen-Free Compliant

Applications

- Synchronous Rectification in DC/DC and AC/DC Converters
- Industrial and Motor Drive applications

Product Summary

V_{DS}	100V
$R_{DS(ON)}$ (at $V_{GS}=10V$)	< 9.7m Ω
$R_{DS(ON)}$ (at $V_{GS}=6V$)	< 12.2m Ω

100% UIS Tested
 100% Rg Tested

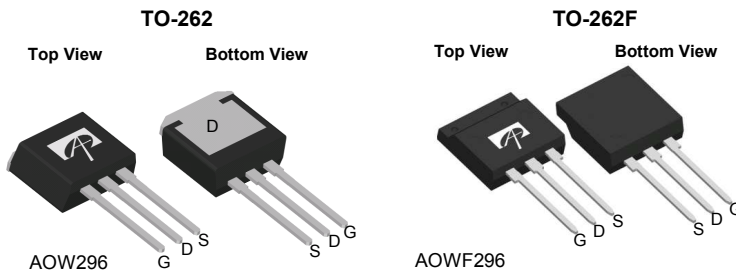

Orderable Part Number	Package Type	Form	Minimum Order Quantity
AOW296	TO-262	Tube	1000
AOWF296	TO-262F	Tube	1000

Absolute Maximum Ratings $T_A=25^\circ\text{C}$ unless otherwise noted

Parameter	Symbol	AOW296 (Max)	AOWF296 (Max)	Units	
Drain-Source Voltage	V_{DS}	100		V	
Gate-Source Voltage	V_{GS}	± 20		V	
Continuous Drain Current ^{G(AOW)}	I_D	$T_C=25^\circ\text{C}$	70	37	A
		$T_C=100^\circ\text{C}$	46.5	23.5	
Pulsed Drain Current ^C	I_{DM}	180	150		
Continuous Drain Current	I_{DSM}	$T_A=25^\circ\text{C}$	18	21	A
		$T_A=70^\circ\text{C}$	14.5	16.5	
Avalanche Current ^C	I_{AS}	40		A	
Avalanche energy $L=0.1\text{mH}$ ^C	E_{AS}	80		mJ	
V_{DS} Spike ^I	V_{SPIKE}	120		V	
Power Dissipation ^B	P_D	$T_C=25^\circ\text{C}$	104	26	W
		$T_C=100^\circ\text{C}$	41.5	10.5	
Power Dissipation ^A	P_{DSM}	$T_A=25^\circ\text{C}$	6.2	8.3	W
		$T_A=70^\circ\text{C}$	4.0	5.3	
Junction and Storage Temperature Range	T_J, T_{STG}	-55 to 150		$^\circ\text{C}$	

Thermal Characteristics

Parameter	Symbol	AOW296 (Max)	AOWF296 (Max)	Units
Maximum Junction-to-Ambient ^A	$R_{\theta JA}$	20	15	$^\circ\text{C/W}$
Maximum Junction-to-Ambient ^{A,D}		Steady-State	65	55
Maximum Junction-to-Case	$R_{\theta JC}$	1.2	4.8	$^\circ\text{C/W}$

Electrical Characteristics (T_J=25°C unless otherwise noted)

Symbol	Parameter	Conditions	Min	Typ	Max	Units	
STATIC PARAMETERS							
BV _{DSS}	Drain-Source Breakdown Voltage	I _D =250μA, V _{GS} =0V	100			V	
I _{DSS}	Zero Gate Voltage Drain Current	V _{DS} =100V, V _{GS} =0V T _J =55°C			1 5	μA	
I _{GSS}	Gate-Body leakage current	V _{DS} =0V, V _{GS} =±20V			±100	nA	
V _{GS(th)}	Gate Threshold Voltage	V _{DS} =V _{GS} , I _D =250μA	2.3	2.9	3.4	V	
R _{DS(on)}	Static Drain-Source On-Resistance	V _{GS} =10V, I _D =20A T _J =125°C		7.9	9.7	mΩ	
		V _{GS} =6V, I _D =20A		13.6	16.6		
g _{FS}	Forward Transconductance	V _{DS} =5V, I _D =20A		62		S	
V _{SD}	Diode Forward Voltage	I _S =1A, V _{GS} =0V		0.7	1	V	
I _S	Maximum Body-Diode Continuous Current ^G	AOW296			70	A	
I _S	Maximum Body-Diode Continuous Current	AOWF296			30	A	
DYNAMIC PARAMETERS							
C _{iss}	Input Capacitance	V _{GS} =0V, V _{DS} =50V, f=1MHz		2785		pF	
C _{oss}	Output Capacitance				238		pF
C _{riss}	Reverse Transfer Capacitance				12		pF
R _g	Gate resistance	f=1MHz	0.25	0.55	0.85	Ω	
SWITCHING PARAMETERS							
Q _{g(10V)}	Total Gate Charge	V _{GS} =10V, V _{DS} =50V, I _D =20A		37	52	nC	
Q _{gs}	Gate Source Charge				11.5		nC
Q _{gd}	Gate Drain Charge				5		nC
Q _{oss}	Output Charge	V _{GS} =0V, V _{DS} =50V		37		nC	
t _{D(on)}	Turn-On DelayTime	V _{GS} =10V, V _{DS} =50V, R _L =2.5Ω, R _{GEN} =3Ω		13		ns	
t _r	Turn-On Rise Time				8.5		ns
t _{D(off)}	Turn-Off DelayTime				29		ns
t _f	Turn-Off Fall Time				4		ns
t _{rr}	Body Diode Reverse Recovery Time	I _F =20A, di/dt=500A/μs		35		ns	
Q _{rr}	Body Diode Reverse Recovery Charge	I _F =20A, di/dt=500A/μs		210		nC	

A. The value of R_{θJA} is measured with the device mounted on 1in² FR-4 board with 2oz. Copper, in a still air environment with T_A=25° C. The Power dissipation P_{DSM} is based on R_{θJA} ≤ 10s and the maximum allowed junction temperature of 150° C. The value in any given application depends on the user's specific board design.

B. The power dissipation P_D is based on T_{J(MAX)}=150° C, using junction-to-case thermal resistance, and is more useful in setting the upper dissipation limit for cases where additional heatsinking is used.

C. Single pulse width limited by junction temperature T_{J(MAX)}=150° C.

D. The R_{θJA} is the sum of the thermal impedance from junction to case R_{θJC} and case to ambient.

E. The static characteristics in Figures 1 to 6 are obtained using <300μs pulses, duty cycle 0.5% max.

F. These curves are based on the junction-to-case thermal impedance which is measured with the device mounted to a large heatsink, assuming a maximum junction temperature of T_{J(MAX)}=150° C. The SOA curve provides a single pulse rating.

G. The maximum current rating is package limited.

H. These tests are performed with the device mounted on 1 in² FR-4 board with 2oz. Copper, in a still air environment with T_A=25° C.

I. The spike duty cycle 5% max, limited by junction temperature T_{J(MAX)}=125° C.

APPLICATIONS OR USE AS CRITICAL COMPONENTS IN LIFE SUPPORT DEVICES OR SYSTEMS ARE NOT AUTHORIZED. AOS DOES NOT ASSUME ANY LIABILITY ARISING OUT OF SUCH APPLICATIONS OR USES OF ITS PRODUCTS. AOS RESERVES THE RIGHT TO IMPROVE PRODUCT DESIGN,FUNCTIONS AND RELIABILITY WITHOUT NOTICE.

TYPICAL ELECTRICAL AND THERMAL CHARACTERISTICS

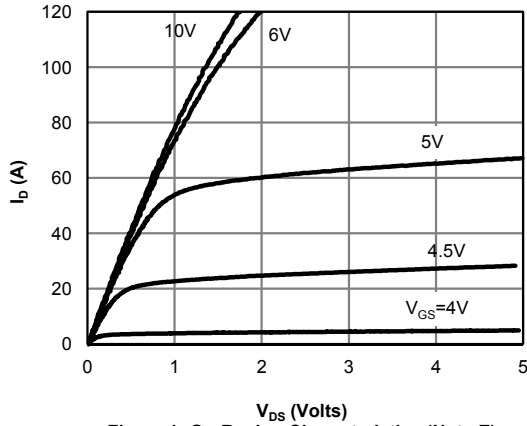

Figure 1: On-Region Characteristics (Note E)

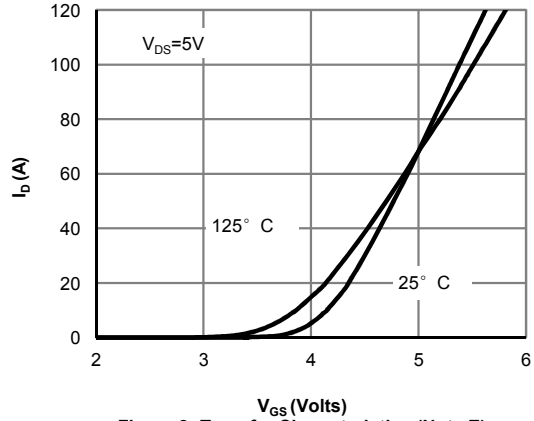

Figure 2: Transfer Characteristics (Note E)

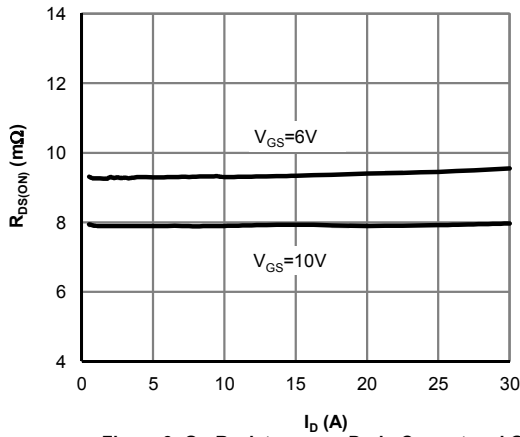

Figure 3: On-Resistance vs. Drain Current and Gate Voltage (Note E)

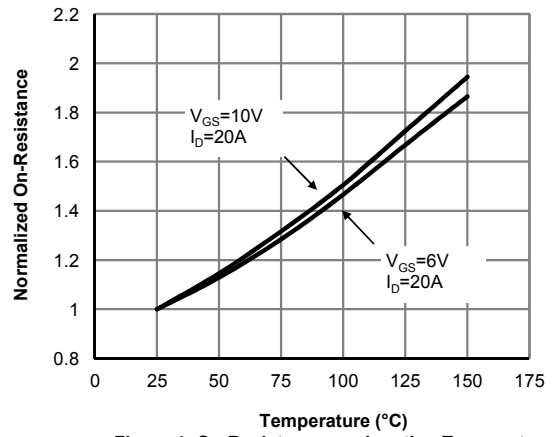

Figure 4: On-Resistance vs. Junction Temperature (Note E)

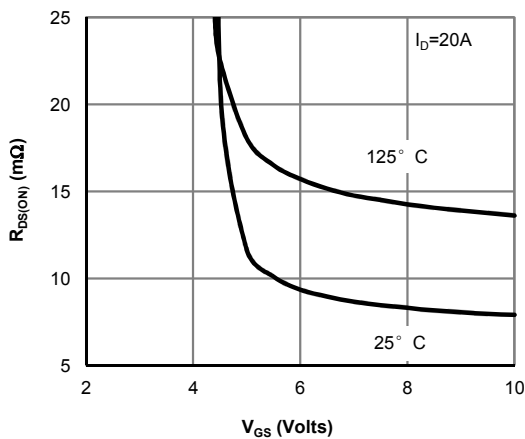

Figure 5: On-Resistance vs. Gate-Source Voltage (Note E)

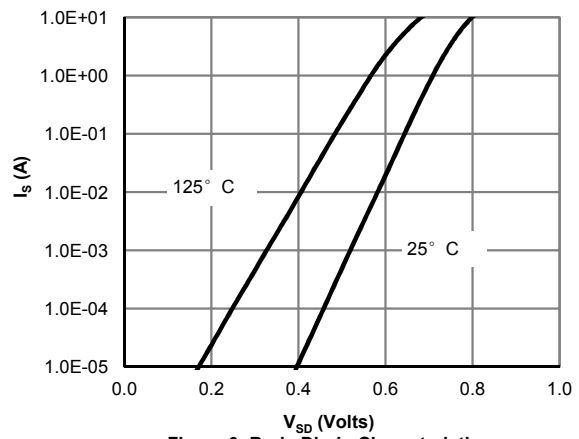

Figure 6: Body-Diode Characteristics (Note E)

TYPICAL ELECTRICAL AND THERMAL CHARACTERISTICS

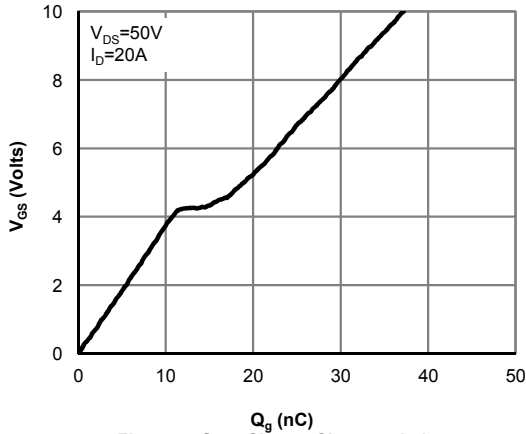

Figure 7: Gate-Charge Characteristics

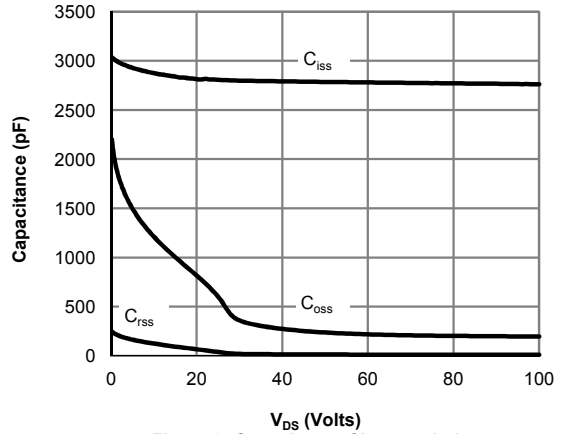

Figure 8: Capacitance Characteristics

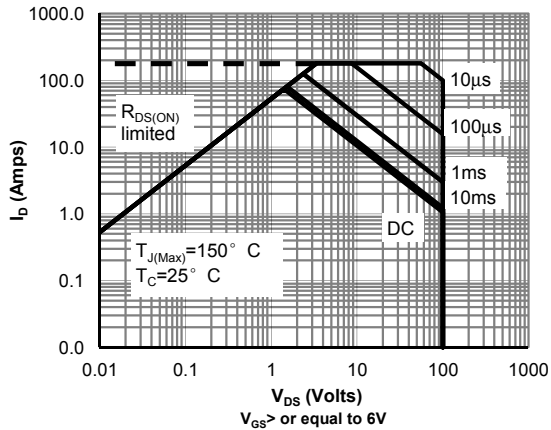

Figure 9: Maximum Forward Biased Safe Operating Area (Note F) - AOW296

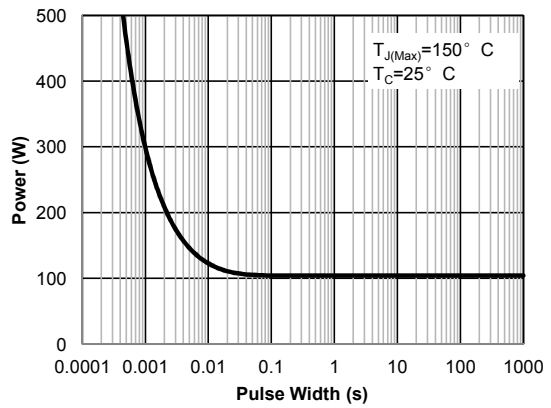

Figure 10: Single Pulse Power Rating Junction-to-Case (Note F) - AOW296

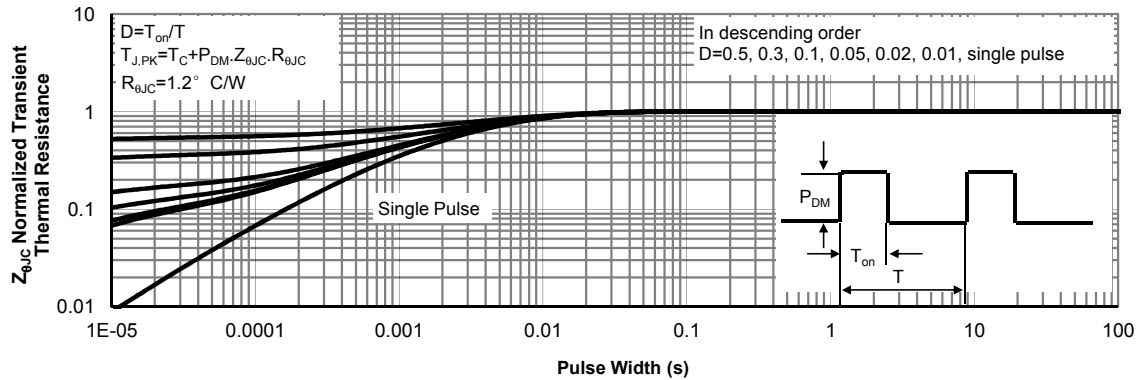

Figure 11: Normalized Maximum Transient Thermal Impedance (Note F) - AOW296

TYPICAL ELECTRICAL AND THERMAL CHARACTERISTICS

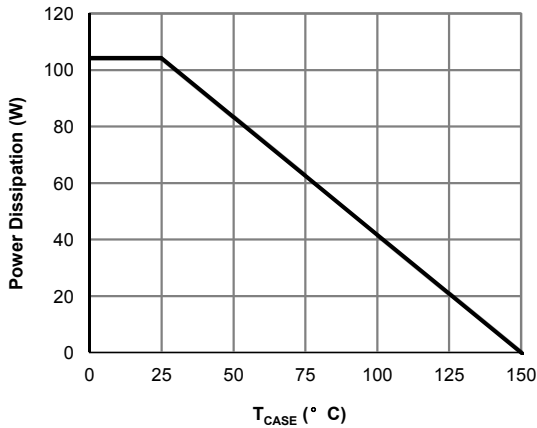

Figure 12: Power De-rating (Note F) - AOW296

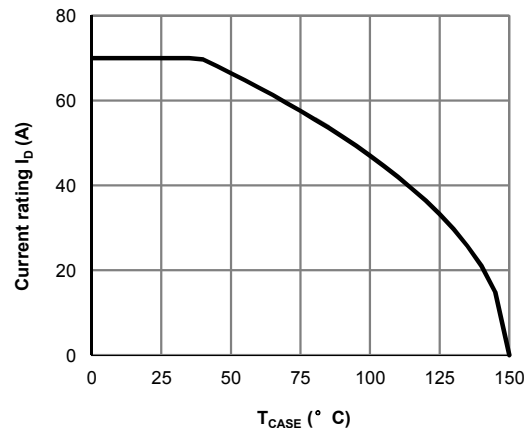

Figure 13: Current De-rating (Note F) - AOW296

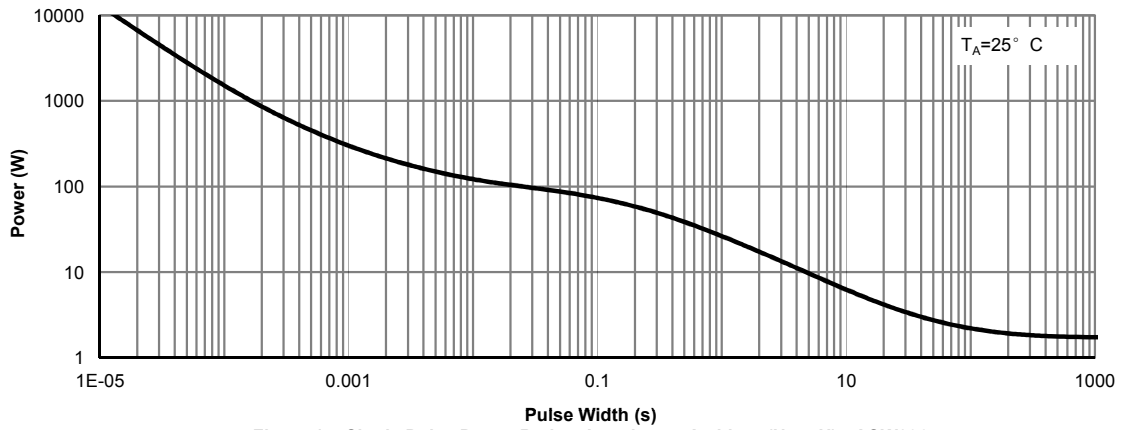

Figure 15: Single Pulse Power Rating Junction-to-Ambient (Note H) - AOW296

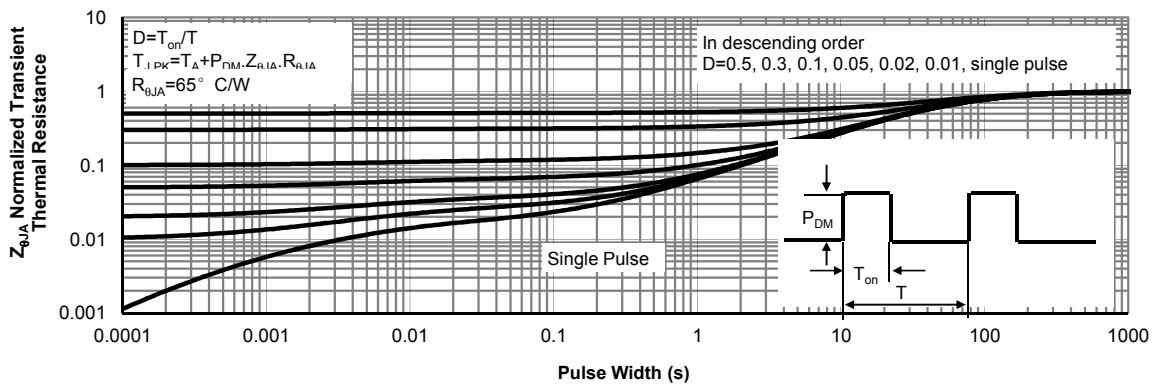
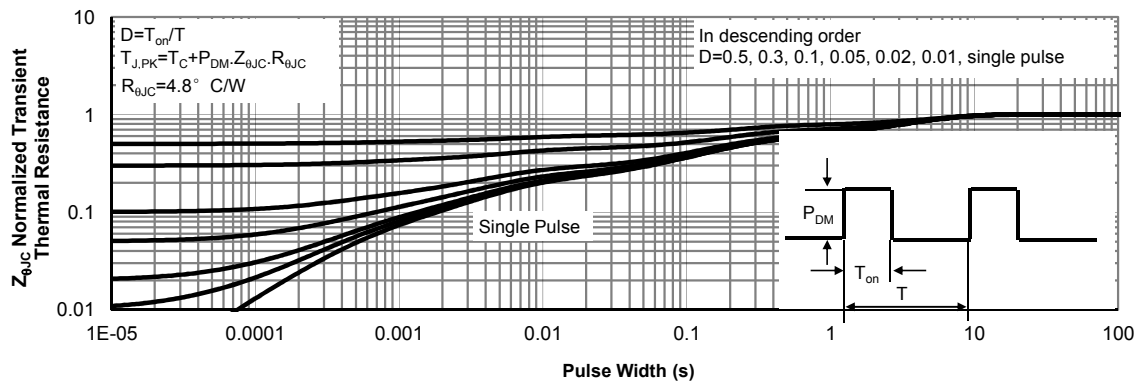
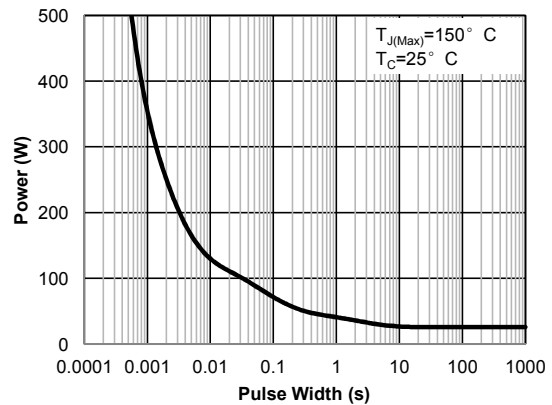
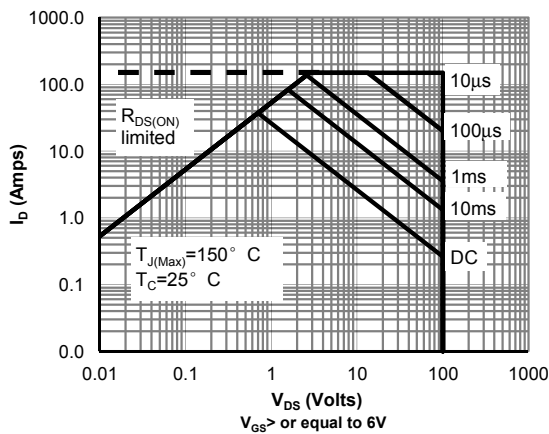

Figure 16: Normalized Maximum Transient Thermal Impedance (Note H) - AOW296

TYPICAL ELECTRICAL AND THERMAL CHARACTERISTICS



TYPICAL ELECTRICAL AND THERMAL CHARACTERISTICS

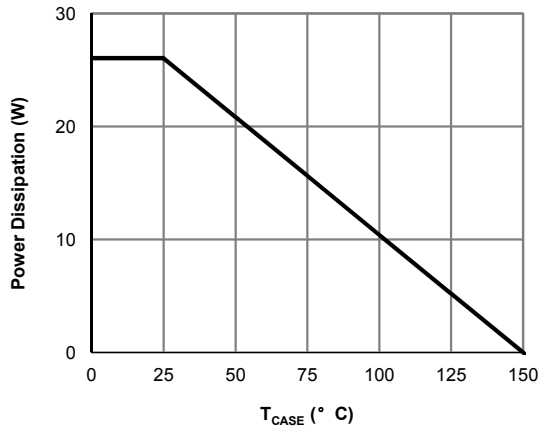

Figure 12: Power De-rating (Note F) - AOWF296

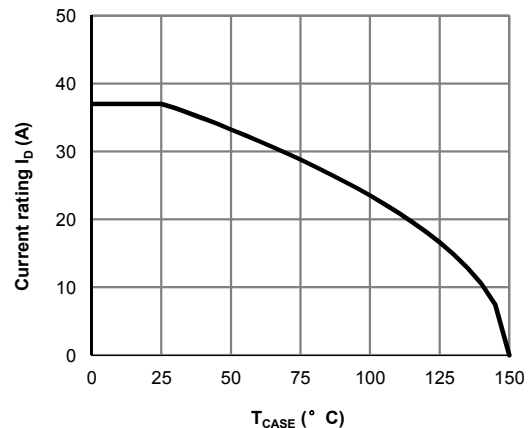

Figure 13: Current De-rating (Note F) - AOWF296

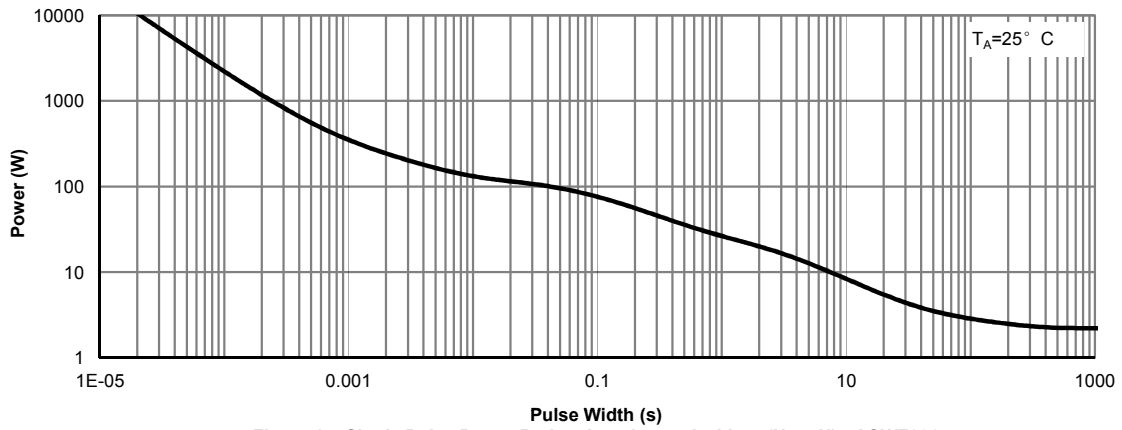

Figure 15: Single Pulse Power Rating Junction-to-Ambient (Note H) - AOWF296

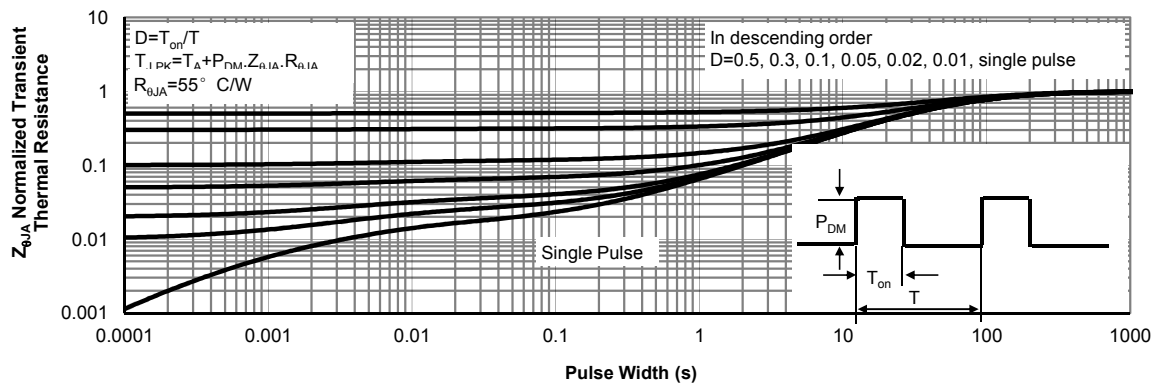

Figure 16: Normalized Maximum Transient Thermal Impedance (Note H) - AOWF296

Figure A: Gate Charge Test Circuit & Waveforms

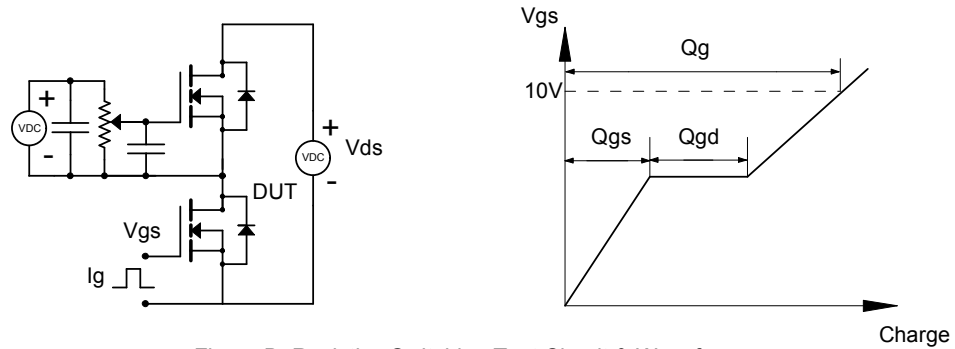

Figure B: Resistive Switching Test Circuit & Waveforms

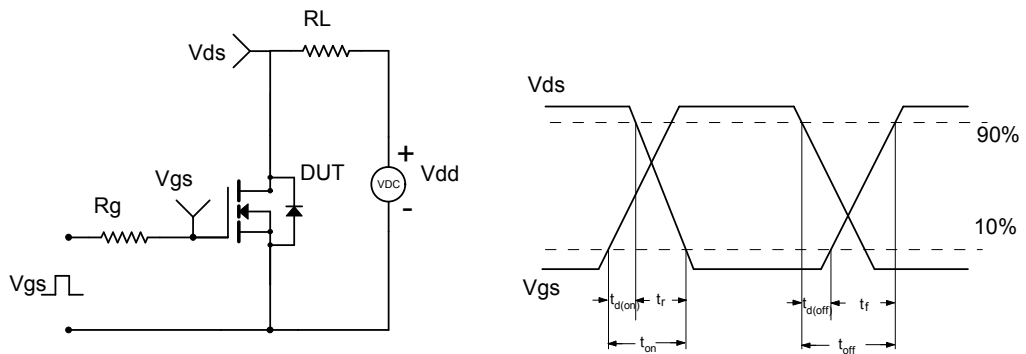

Figure C: Unclamped Inductive Switching (UIS) Test Circuit & Waveforms

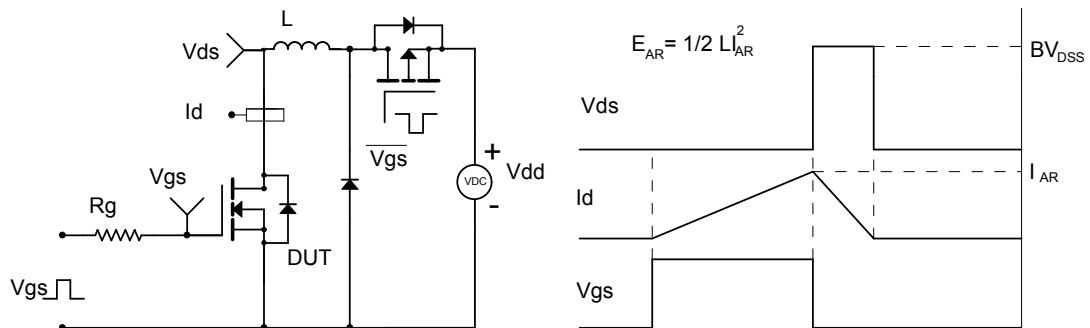
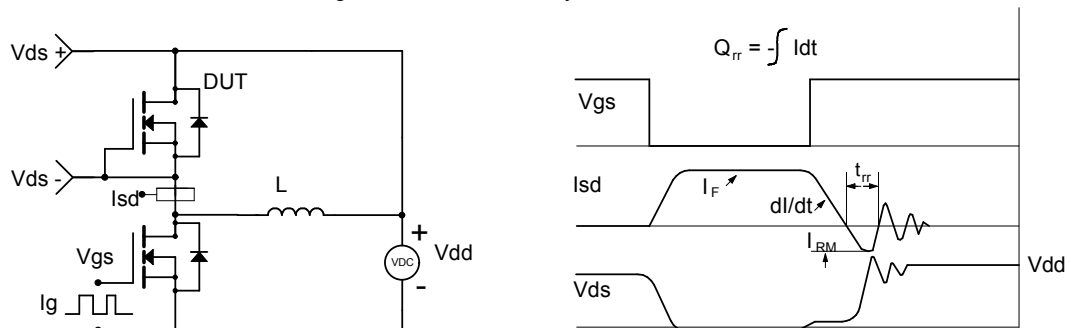

Figure D: Diode Recovery Test Circuit & Waveforms



单击下面可查看定价，库存，交付和生命周期等信息

[>>AOS\(万国半导体\)](#)