

General Description

The AOZ1336DI is a single channel load switch with typical 27mΩ on-resistance in a small package. It contains an n-channel MOSFET for up to 5.5V input voltage operation and 4A current channel with 2.5V to 5V bias supply. The load switch is independently controlled by a low voltage control signal through ON pin.

The AOZ1336DI integrates an internal 220Ω load resistor for quick output discharge when load switch is off. The optional external capacitor connected CT for output slew rate control.

The AOZ1336DI is available in a 2mm x 2mm DFN-8L package with bottom thermal pad and is rated over a -40°C to +85°C ambient temperature range.

Features

- 0.8V to 5.5V input voltage range
- 4A continuous current
- Low $R_{DS(ON)}$ internal NFETs
– 27mΩ at $V_{BIAS} = 2.5V$ to 5V & $V_{BIAS} \geq V_{IN}$
- 50μA low quiescent current
- Adjustable rise time
- 2.5V to 5V bias voltage
- Integrated quick output discharge resistor
- Thermally enhanced 2mm x 2mm DFN-8L package

Applications

- Portable computers
- Ultrabooks
- Tablet PC
- Set top boxes
- LCD TVs
- Telecom/Networking/Datacom equipment
- SSD
- Consumer electronics



Typical Application

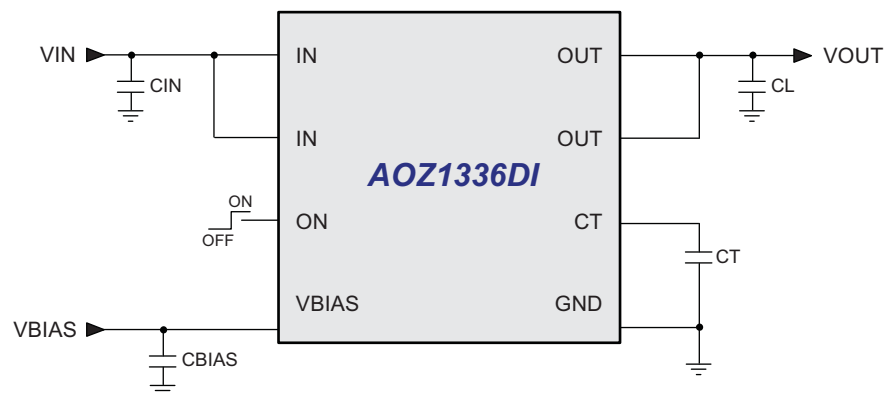

Ordering Information

Part Number	Temperature Range	Package	Environmental
AOZ1336DI	-40°C to +85°C	2mm x 2mm DFN-8L	Green



All AOS products are offered in packages with Pb-free plating and compliant to RoHS standards. Please visit www.aosmd.com/media/AOSGreenPolicy.pdf for additional information.

Pin Configuration

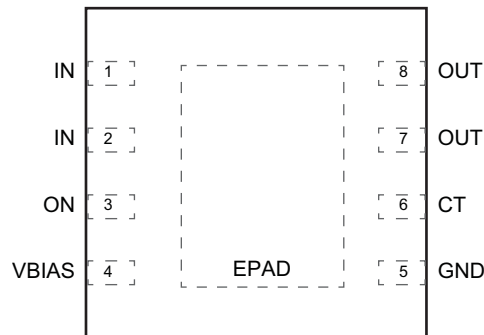

2mm x 2mm DFN-8
(Top View)

Pin Description

Pin Number	Pin Name	Pin Function
1, 2	IN	Load Switch Input. Bypass IN and GND with ceramic capacitor.
3	ON	Enable Input. Load switch is on when ON is pulled high. Load switch is off when ON is pulled low.
4	VBIAS	Supply input for the device.
5	GND	Ground.
6	CT	Load switch slew rate control.
7, 8	OUT	Load switch output.
EPAD	Exposed Pad	The exposed bottom pad must be connected to GND.

Functional Block Diagram

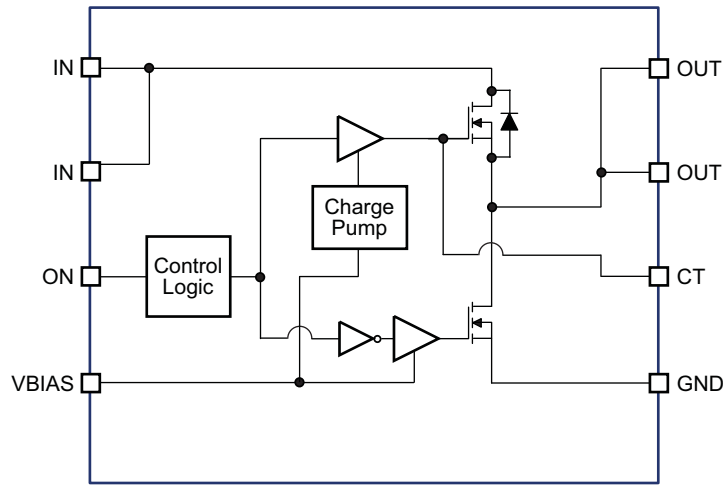

Absolute Maximum Ratings

Exceeding the Absolute Maximum ratings may damage the device.

Parameter	Rating
IN, ON, VBIAS, OUT to GND	-0.3V to 6V
Junction Temperature (T_J)	+150°C
Storage Temperature (T_S)	-65°C to +150°C
ESD Rating HBM/CDM	2kV/1kV

Recommend Operating Ratings

The device is not guaranteed to operate beyond the Maximum Operating Ratings.

Parameter	Rating
Supply Voltage (V_{IN})	5.5V
Ambient Temperature (T_A)	-40°C to +85°C
Package Thermal Resistance	
2x2 DFN-8 (θ_{JC})	12°C/W
2x2 DFN-8 (θ_{JA})	90°C/W

Electrical Characteristics

$T_A = 25^\circ\text{C}$, $V_{BIAS} = 5\text{V}$, unless otherwise specified. Specifications in **BOLD** indicate a temperature range of -40°C to +85°C.

Symbol	Parameter	Conditions	Min.	Typ.	Max.	Units
V_{IN}	IN Supply Voltage		0.8		V_{BIAS}	V
V_{BIAS}	VBIAS Supply Voltage		2.5		5.5	V
I_q	Quiescent Supply Current of V_{BIAS}	$I_{OUT} = 0\text{V}$, $V_{ON} = 0\text{V}$, $V_{IN} = V_{ON} = 5\text{V}$		50	75	μA
I_{OFF}	VBIAS Shutdown Supply Current	$V_{ON} = 0\text{V}$, $V_{OUT} = 0\text{V}$		1	2	μA
I_D	Maximum Continuous Current	$V_{IN} = V_{ON} = 5\text{V}$		4		A
I_{PLS}	Maximum Pulsed Switch Current	$V_{IN} = V_{ON} = 5\text{V}$ Pulse < 300 μs , 2% Duty Cycle		6		A
I_{INOFF}	IN Shutdown Supply Current	$V_{ON} = 0\text{V}$, $V_{OUT} = 0\text{V}$, $V_{IN} = 5\text{V}$		2.1	8	μA
		$V_{ON} = 0\text{V}$, $V_{OUT} = 0\text{V}$, $V_{IN} = 3.3\text{V}$		0.3	3	
		$V_{ON} = 0\text{V}$, $V_{OUT} = 0\text{V}$, $V_{IN} = 1.8\text{V}$		0.07	2	
		$V_{ON} = 0\text{V}$, $V_{OUT} = 0\text{V}$, $V_{IN} = 0.8\text{V}$		0.04	1	
I_{ON}	ON Leakage Current	$V_{ON} = 5\text{V}$			1	μA
V_{ONH}	ON High Level Voltage	$V_{IN} = 0.8\text{V}$ to 5V	1.2			V
V_{ONL}	ON Low Level Voltage	$V_{IN} = 0.8\text{V}$ to 5V			0.5	V
Switching ON Resistance						
R_{ON}	Switch ON-State Resistance	$I_{OUT} = -200\text{mA}$, $V_{IN} = 0.8\text{V}$ to 5V		27	33	m Ω
R_{PD}	Output Pull-Down Resistance	$I_{OUT} = 15\text{mA}$, $V_{IN} = 5\text{V}$, $V_{ON} = 0\text{V}$		220	300	Ω

Note:

Greater on-resistance if $V_{IN} > V_{BIAS}$.

Switching Characteristics

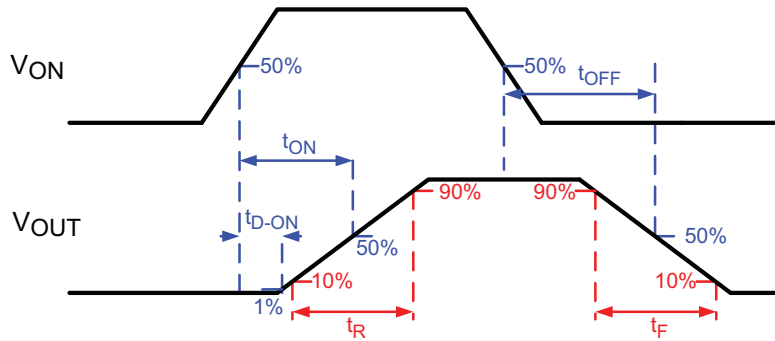

Test conditions: $T_A = 25^\circ\text{C}$, $C_{IN} = 1\mu\text{F}$, $C_T = 1\text{nF}$, $C_L = 0.1\mu\text{F}$, $R_L = 10\Omega$ (unless otherwise specified).

Symbol	Parameter	Min.	Typ.	Max.	Units
VIN = 5V, VBIAS = VON = 5V					
t _{ON}	Turn-ON Time		1420		μs
t _{D-ON}	Turn-ON Delay time		450		
t _R	Turn-ON Rise Time		1740		
t _{OFF}	Turn-OFF Time		7.7		
t _F	Turn-OFF Fall Time		2.5		
VIN = 0.8V, VBIAS = VON = 5V					
t _{ON}	Turn-ON Time		620		μs
t _{D-ON}	Turn-ON Delay time		450		
t _R	Turn-ON Rise Time		280		
t _{OFF}	Turn-OFF Time		89		
t _F	Turn-OFF Fall Time		10		
VIN = 2.5V, VBIAS = VON = 2.5V					
t _{ON}	Turn-ON Time		2100		μs
t _{D-ON}	Turn-ON Delay time		780		
t _R	Turn-ON Rise Time		2200		
t _{OFF}	Turn-OFF Time		8		
t _F	Turn-OFF Fall Time		2.5		
VIN = 0.8V, VBIAS = VON = 2.5V					
t _{ON}	Turn-ON Time		1250		μs
t _{D-ON}	Turn-ON Delay time		730		
t _R	Turn-ON Rise Time		750		
t _{OFF}	Turn-OFF Time		76		
t _F	Turn-OFF Fall Time		10		

Typical Characteristics

Quiescent Current vs. VBIAS
(VIN=VBIAS, VON=5V)

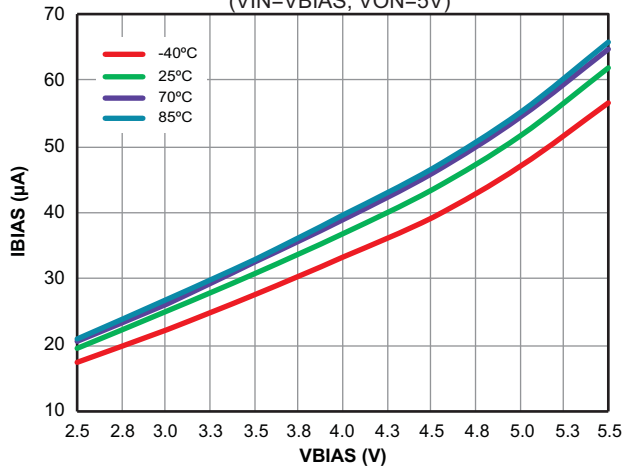

RPD vs. VIN
(VBIAS=5.5V)

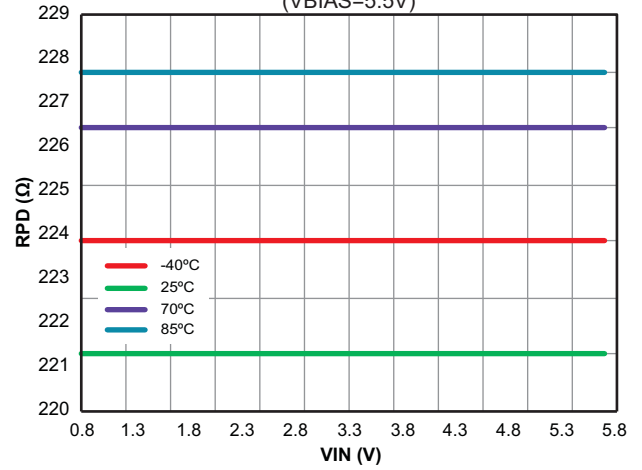

RDSON vs. VIN
(VBIAS=2.5V, IOU=-200mA)

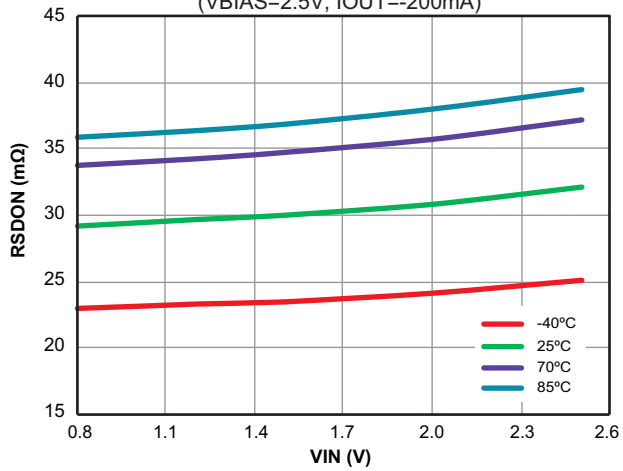

VOUT vs. VON
(TA=25°C, VOUT=2V)

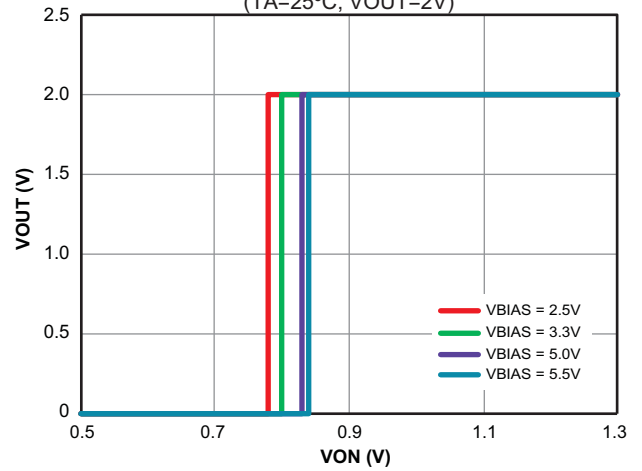

RDSON vs. VIN
(VBIAS=5.5V, IOU=-200mA)

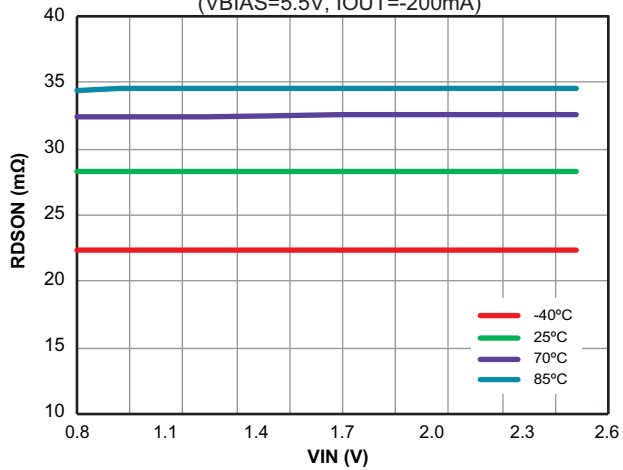

Typical Characteristics (Continued)

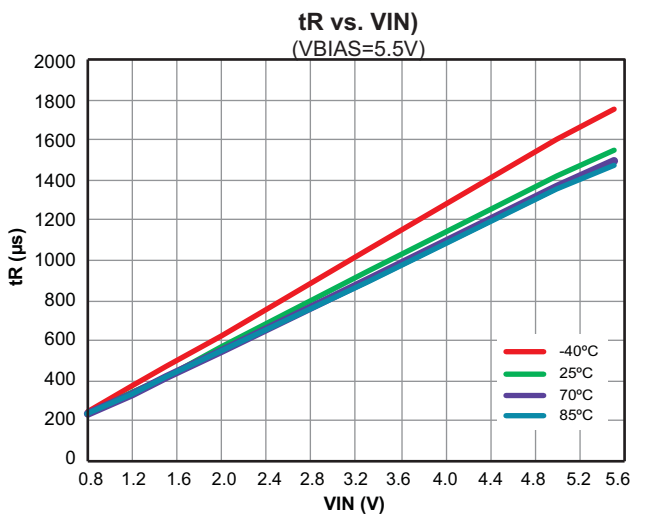
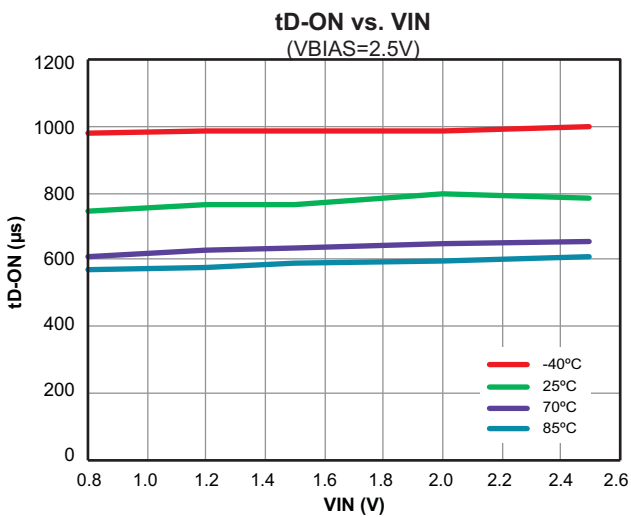
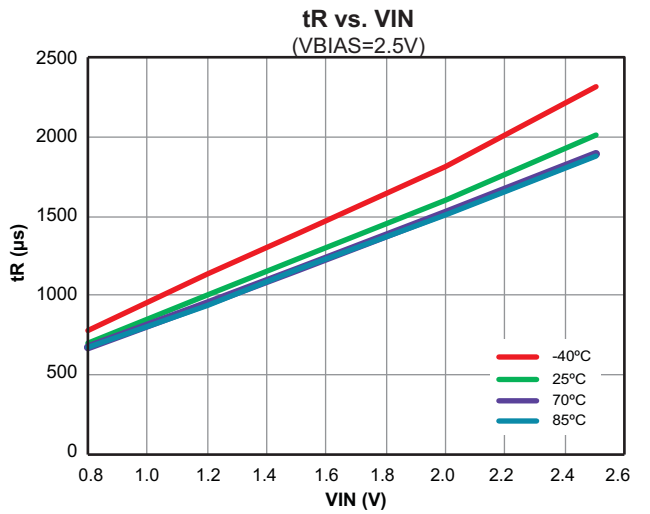
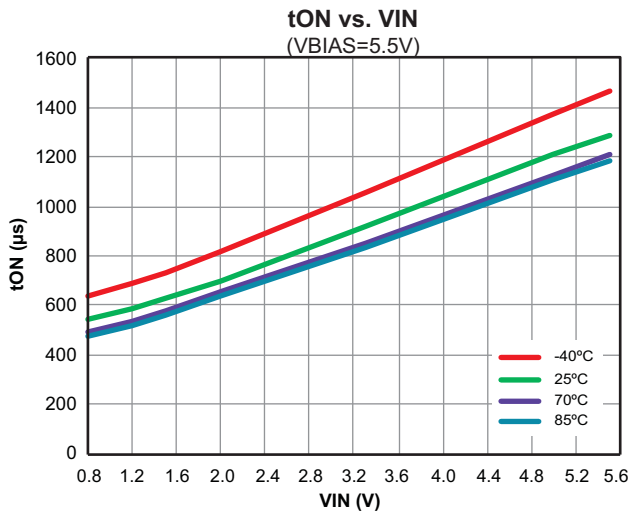
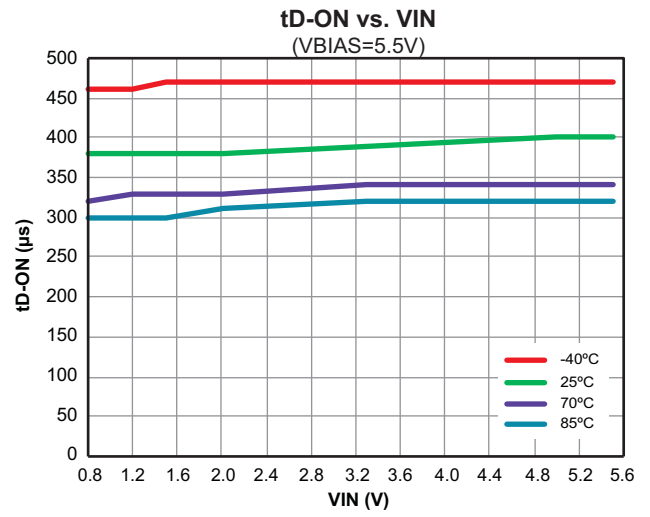
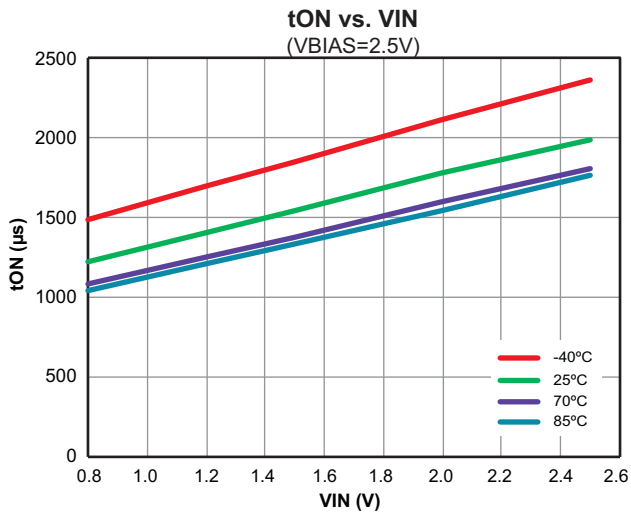

Typical Characteristics (Continued)

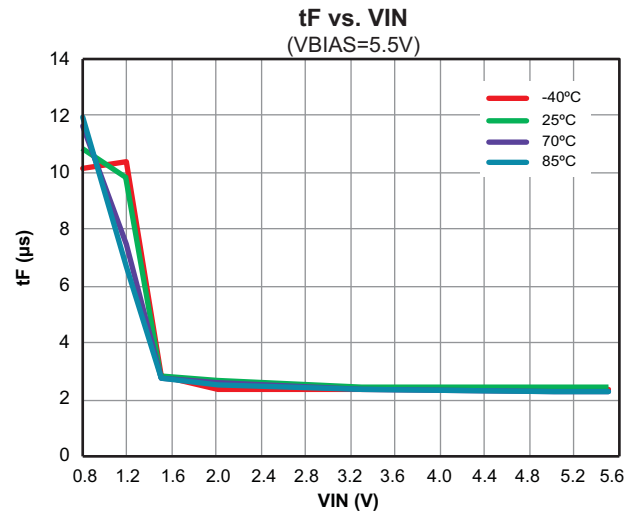
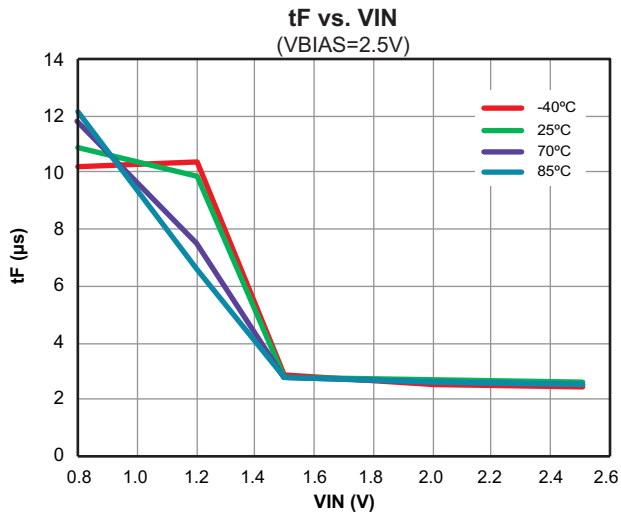
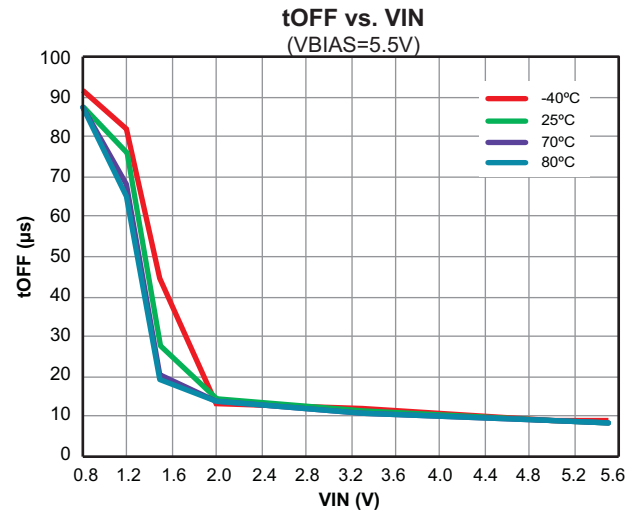
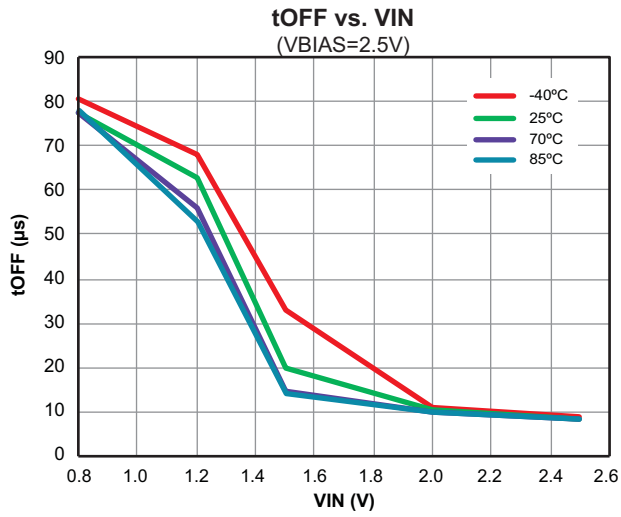

Functional Characteristics

Turn-ON & Turn-ON Rise Times

($V_{IN}=5V$, $V_{BIAS}=5V$, $C_{IN}=1\mu F$, $C_T=1nF$, $C_L=0.1\mu F$, $R_L=10\Omega$)

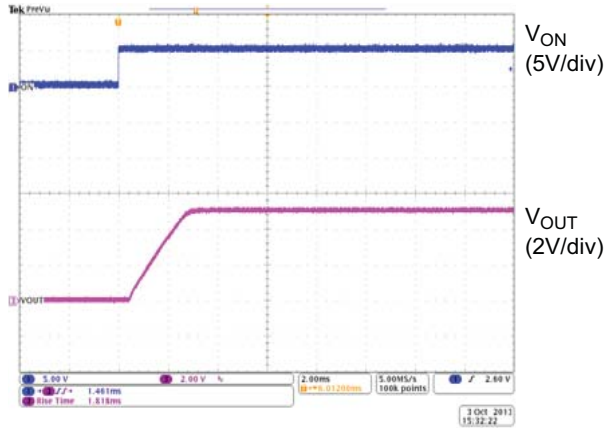

Turn-ON & Turn-ON Rise Times

($V_{IN}=0.8V$, $V_{BIAS}=5V$, $C_{IN}=1\mu F$, $C_T=1nF$, $C_L=0.1\mu F$, $R_L=10\Omega$)

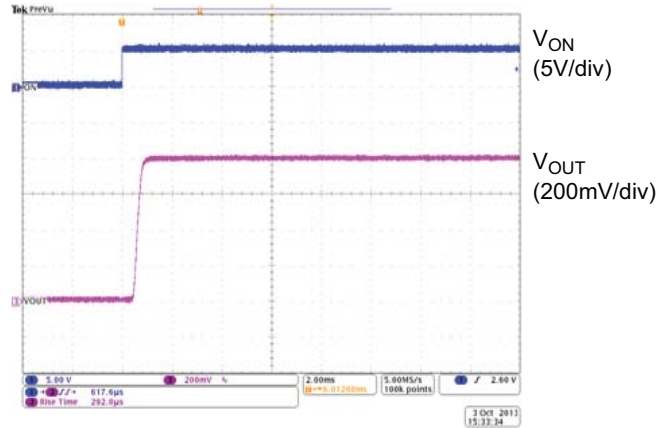

Turn-ON & Turn-ON Rise Times

($V_{IN}=2.5V$, $V_{BIAS}=2.5V$, $C_{IN}=1\mu F$, $C_T=1nF$, $C_L=0.1\mu F$, $R_L=10\Omega$)

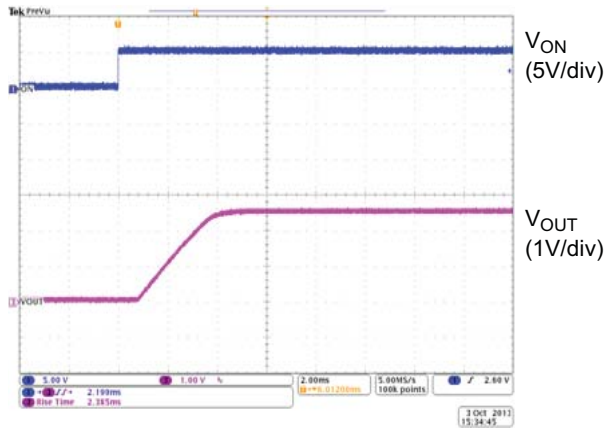

Turn-ON & Turn-ON Rise Times

($V_{IN}=0.8V$, $V_{BIAS}=2.5V$, $C_{IN}=1\mu F$, $C_T=1nF$, $C_L=0.1\mu F$, $R_L=10\Omega$)

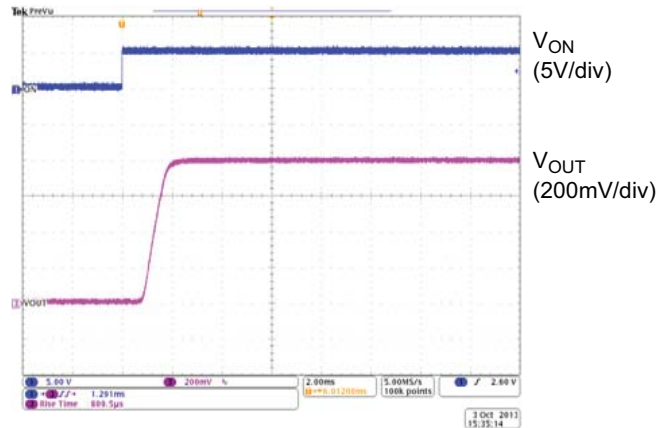

Turn-OFF & Turn-OFF Fall Times

($V_{IN}=5V$, $V_{BIAS}=5V$, $C_{IN}=1\mu F$, $C_T=1nF$, $C_L=0.1\mu F$, $R_L=10\Omega$)

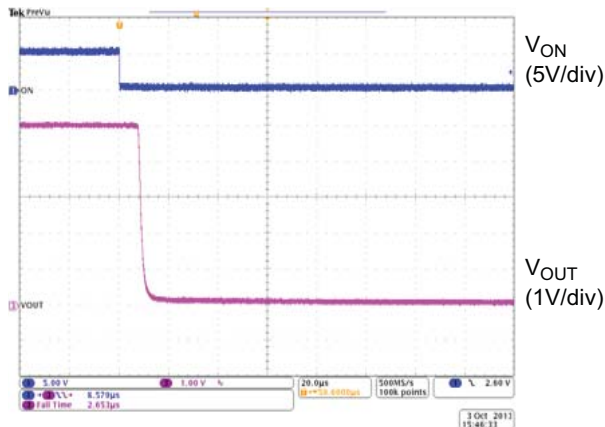

Turn-OFF & Turn-OFF Fall Times

($V_{IN}=0.8V$, $V_{BIAS}=5V$, $C_{IN}=1\mu F$, $C_T=1nF$, $C_L=0.1\mu F$, $R_L=10\Omega$)

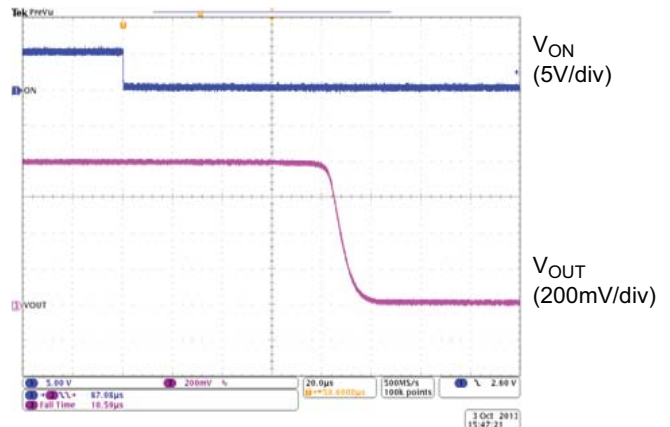

Functional Characteristics (Continued)

Turn-OFF Fall Times

($V_{IN}=2.5V$, $V_{BIAS}=2.5V$, $C_{IN}=1\mu F$, $C_T=1nF$, $C_L=0.1\mu F$, $R_L=10\Omega$)

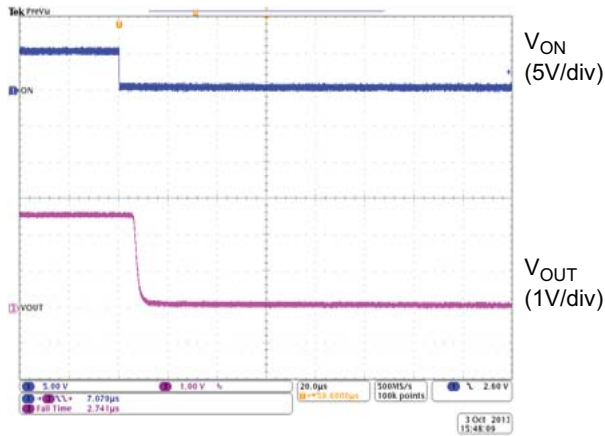

Turn-OFF Fall Times

($V_{IN}=0.8V$, $V_{BIAS}=2.5V$, $C_{IN}=1\mu F$, $C_T=1nF$, $C_L=0.1\mu F$, $R_L=10\Omega$)

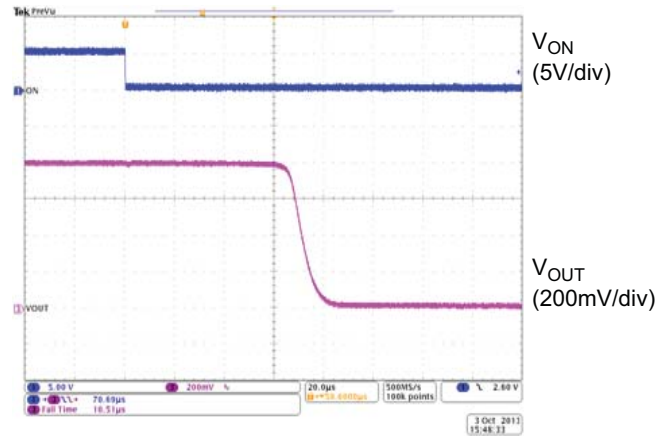

Turn-ON & Turn-OFF @ $I_{OUT} = 4A$

($V_{IN}=5V$, $V_{BIAS}=5V$, $C_{IN}=4.7\mu F$, $C_L=4.7\mu F$)

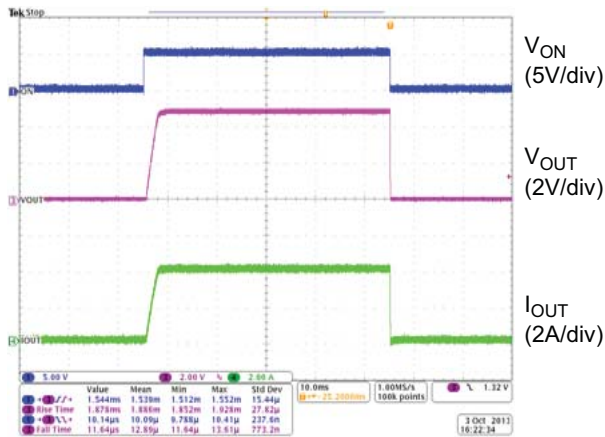

Turn-ON & Turn-OFF @ $I_{OUT} = 4A$

($V_{IN}=2.5V$, $V_{BIAS}=5V$, $C_{IN}=4.7\mu F$, $C_L=4.7\mu F$)

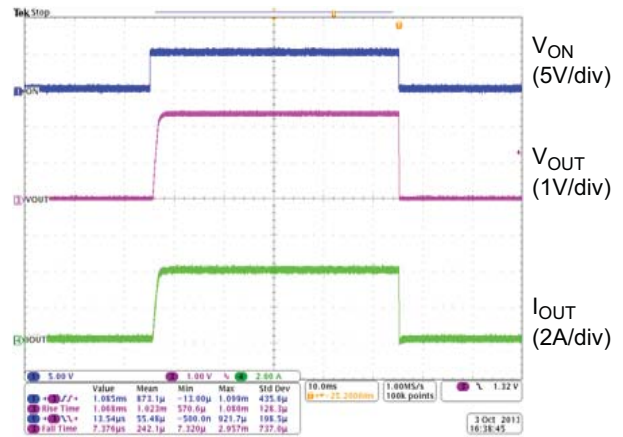

Detailed Description

ON/OFF Control

The AOZ1336DI is enabled when the ON pin is on active high with 1.2V or above voltage. The device is disabled when the ON pin voltage is 0.5V or lower. The EN input is compatible with both TTL and CMOS logic.

VBIAS Voltage Range

For optimal on-resistance of load switch, make sure $V_{IN} \leq V_{BIAS}$ and V_{BIAS} is within the voltage range from 2.5V to 5.5V. On-resistance of load switch will be higher if $V_{IN} > V_{BIAS}$. Resistance curves of a typical sample device at different V_{BIAS} and different V_{IN} are shown as below.

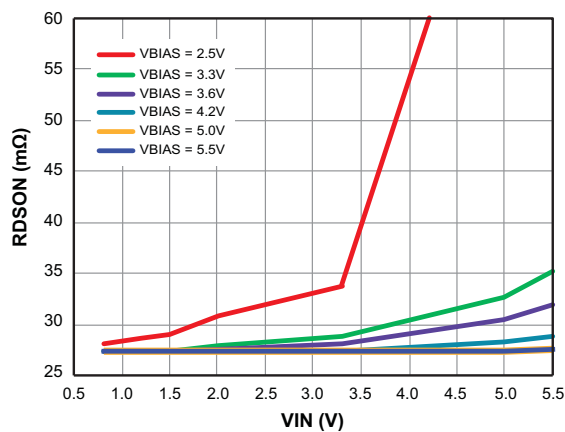

Adjustable Rise Time

The slew rate of V_{OUT} can be adjusted by external capacitors connected to the corresponding CT and GND pins. Multiply the input voltage and the slew rate to obtain the rise time. The table below shows rise times, which are measured on a typical device at V_{BIAS} = 5V.

C _T (pF)	Rise Time (μs) 10%~90%, C _L =0.1μF, C _{IN} 1μF, R _L =10Ω (Typical values at 25°C, 25V X7R 10% Ceramic Cap)						
	V _{IN} =5V	3.3V	1.8V	1.5V	1.2V	1.05V	0.8V
0	58	42	33	29	26	24	22
220	372	226	130	104	91	81	66
470	740	486	255	198	169	148	115
1000	1607	1021	570	452	366	322	252
2200	3532	2447	1351	1139	904	785	664
4700	7275	4708	2802	2277	1920	1663	1286
10000	16640	10700	6372	5176	4425	3868	3098

Applications Information

The basic AOZ1336DI application circuit is shown in the first page. Component selection is explained below.

Input Capacitor Selection

A capacitor of 1μF or higher value is recommended to be placed close to the IN pins of AOZ1336DI. This capacitor can reduce the voltage drop caused by the in-rush current during the turn-on transient of the load switch. A higher value capacitor can be used to further reduce the voltage drop during high-current application.

Output Capacitor Selection

A capacitor of 0.1μF or higher value is recommended to be placed between the OUT pins and GND. The switching times are affected by the capacitance. A larger capacitor makes the initial turn-on transient smoother. This capacitor must be large enough to supply a fast transient load in order to prevent the output from dropping.

Thermal Considerations

To ensure proper operation, the maximum junction temperature of the AOZ1336DI should not exceed 150°C. Several factors attribute to the junction temperature rise: load current, MOSFET on-resistance, junction-to-ambient thermal resistance, and ambient temperature. The maximum load current can be determined by:

$$I_{LOAD(MAX)} = \sqrt{\frac{T_{J(MAX)} - T_C}{\Theta_{JC} \times R_{DS(on)}}$$

It is noted that the maximum continuous load current is 4A.

Layout Guidelines

Good PCB is important for improving the thermal performance of AOZ1336DI. Place the input and output bypass capacitors close to the IN and OUT pins. The input and output PCB traces should be as wide as possible for the given PCB space. Use a ground plane to enhance the power dissipation capability of the device.

Package Dimensions, DFN2x2_8L, EP1_S

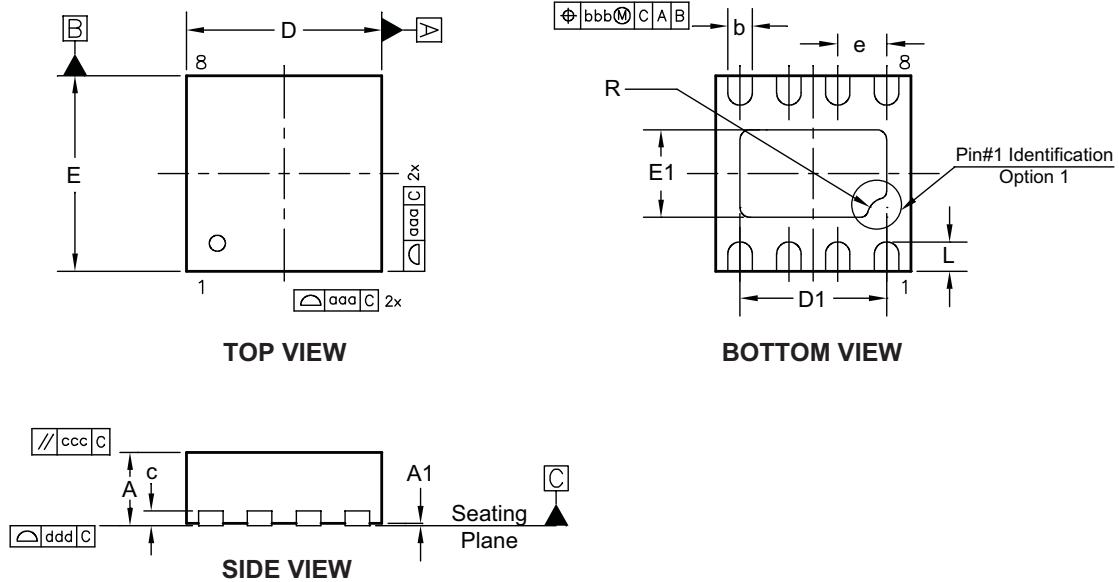

RECOMMENDED LAND PATTERN

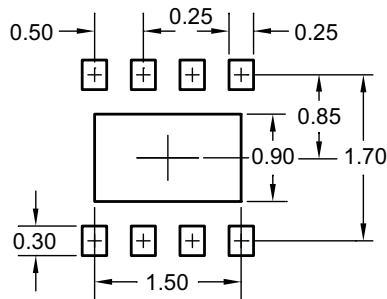

UNIT: mm

Dimensions in millimeters

Symbols	Min.	Nom.	Max.
A	0.70	0.75	0.80
A1	0.00	0.02	0.05
b	0.18	0.25	0.30
c	0.20 REF		
D	1.90	2.00	2.10
D1	1.10	1.50	1.60
E	1.90	2.00	2.10
E1	0.50	0.90	1.00
e	0.50 BSC		
L	0.20	0.30	0.40
R	0.20		
aaa	0.15		
bbb	0.10		
ccc	0.10		
ddd	0.08		

Dimensions in inches

Symbols	Min.	Nom.	Max.
A	0.028	0.030	0.031
A1	0.000	0.001	0.002
b	0.007	0.010	0.012
c	0.008 REF		
D	0.075	0.079	0.083
D1	0.043	0.059	0.063
E	0.075	0.079	0.083
E1	0.020	0.035	0.039
e	0.020 BSC		
L	0.008	0.012	0.016
R	0.008		
aaa	0.006		
bbb	0.004		
ccc	0.004		
ddd	0.003		

Notes:

1. Dimensions and tolerances conform to ASME Y14.5M-1994.
2. Controlling dimension is millimeter, converted inch dimensions are not necessarily exact.
3. Dimension b applied to metallized terminal and is measured between 0.10mm and 0.30mm from the terminal tip. If the terminal has the optional radius on the other end of the terminal, dimension b should not be measured in that radius area.
4. Coplanarity ddd applies to the terminals and all other bottom surface metallization.

Tape and Reel Dimensions, DFN2x2_8L, EP1_S

Carrier Tape

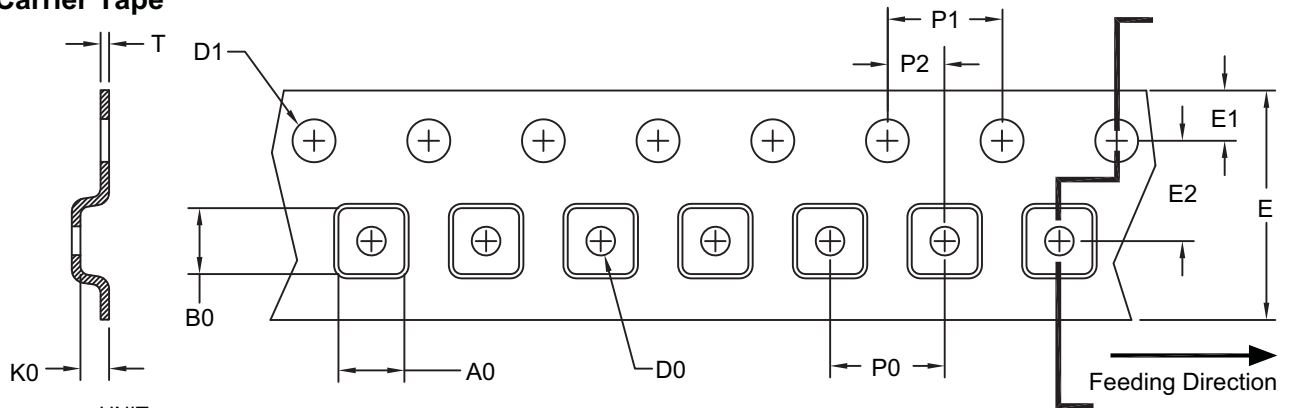

UNIT: mm

Package	A0	B0	K0	D0	D1	E	E1	E2	P0	P1	P2	T
DFN 2x2	2.30 ±0.20	2.30 ±0.20	1.00 ±0.20	1.00 MIN.	1.50 +0.10/-0.0	8.00 +0.30/-0.10	1.75 ±0.10	3.50 ±0.05	4.00 ±0.20	4.00 ±0.20	2.00 ±0.05	0.30 ±0.05

Reel

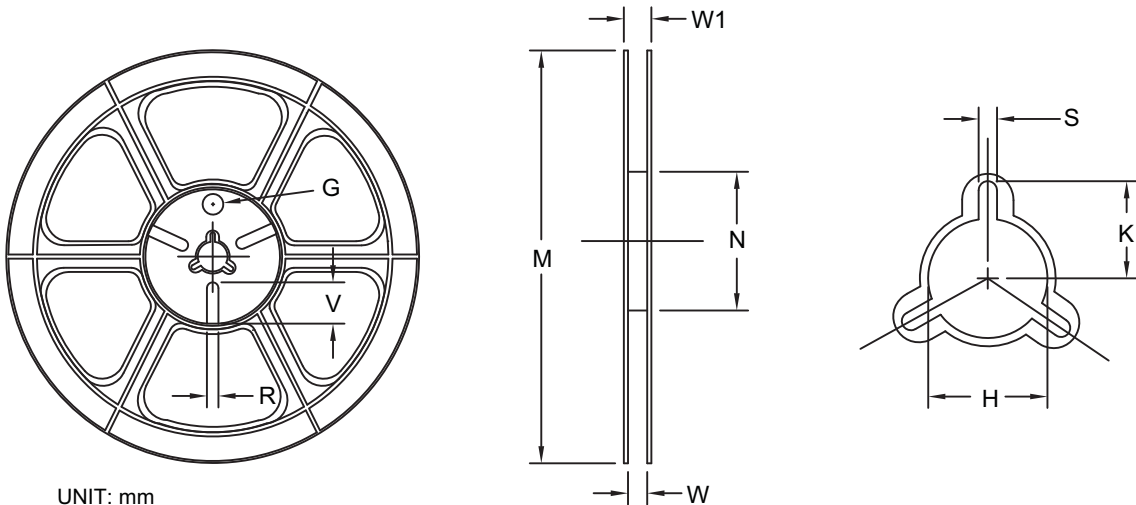

UNIT: mm

Tape Size	Reel Size	M	N	W	W1	H	K	S	G	R	V
8mm	ø178	ø178.00 ±1.00	ø70.50 ±1.00	9.00 ±0.50	11.80 ±1.10	ø13.00 +0.5/-0.2	10.25 ±0.20	2.40 ±0.10	ø9.80	N/A	N/A

Leader / Trailer & Orientation

Unit Per Reel:
3000pcs

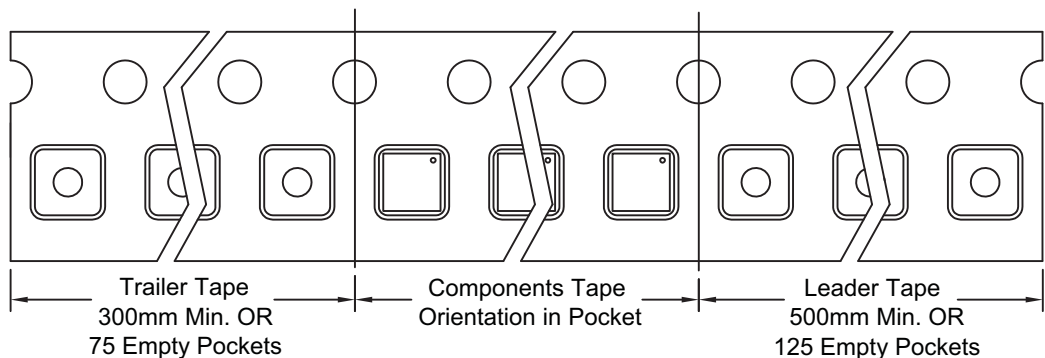

Package Marking

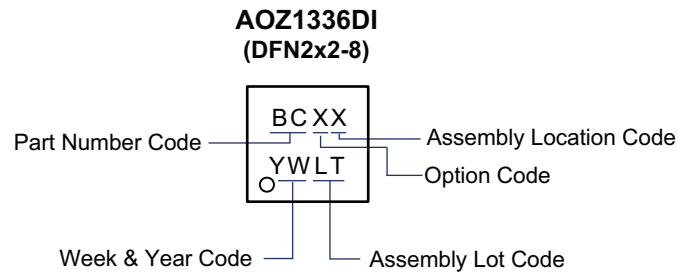

LEGAL DISCLAIMER

Applications or uses as critical components in life support devices or systems are not authorized. AOS does not assume any liability arising out of such applications or uses of its products. AOS reserves the right to make changes to product specifications without notice. It is the responsibility of the customer to evaluate suitability of the product for their intended application. Customer shall comply with applicable legal requirements, including all applicable export control rules, regulations and limitations.

AOS' products are provided subject to AOS' terms and conditions of sale which are set forth at:

http://www.aosmd.com/terms_and_conditions_of_sale

LIFE SUPPORT POLICY

ALPHA AND OMEGA SEMICONDUCTOR PRODUCTS ARE NOT AUTHORIZED FOR USE AS CRITICAL COMPONENTS IN LIFE SUPPORT DEVICES OR SYSTEMS.

As used herein:

- | | |
|---|---|
| <p>1. Life support devices or systems are devices or systems which, (a) are intended for surgical implant into the body or (b) support or sustain life, and (c) whose failure to perform when properly used in accordance with instructions for use provided in the labeling, can be reasonably expected to result in a significant injury of the user.</p> | <p>2. A critical component in any component of a life support, device, or system whose failure to perform can be reasonably expected to cause the failure of the life support device or system, or to affect its safety or effectiveness.</p> |
|---|---|

单击下面可查看定价，库存，交付和生命周期等信息

[>>AOS\(万代\)](#)