

General Description

The AOZ1353LI is a current-limited power switch targeting applications that require comprehensive protections. The input operating voltage range is between 3.4V and 5.5V. The output terminal is rated 28V absolute maximum. The internal current-limiting circuit protects the supply from large load current. The current limit level is set with an external resistor. The soft-start circuit controls inrush current due to highly capacitive loads. The soft-start time can be optionally adjusted with an external capacitor. The device features very low quiescent current of 125µA. The supply current reduces 6µA in shutdown. It also has under-voltage lockout (UVLO), over-voltage protection (OVP) and thermal shutdown protection.

The AOZ1353LI has True Reverse-Current Blocking (TRCB) protection to avoid undesired reverse-current from VOUT to VIN.

The device features fast recovery to turn on power switch once reverse current blocking protection is deactivated.

The AOZ1353LI is available in a 1.31mm x 1.81mm Wafer-Level Chip-Scale Package (WLCSP with 12 bumps).

Features

- 28V voltage rating on VOUT pin
- 3.4V to 5.5V operating input voltage
- 3.5A current capability
- Typical R_{ON} : 32mΩ
- Programmable current limit
- True Reverse-Current Blocking (TRCB)
- Fast recovery from TRCB
- Adjustable soft-start
- 125µA quiescent current
- Over-voltage protection
- Input under-voltage lockout
- Thermal shutdown protection
- ±4kV HBM rating
- ±1kV CDM Rating
- UL2367 file no. E326264
- IEC62368 file no. E326264-A6002

Applications

- USB PD power source switch
- Smart phone and tablet
- Notebook, ultrabook and desktop
- Portable devices



Typical Application

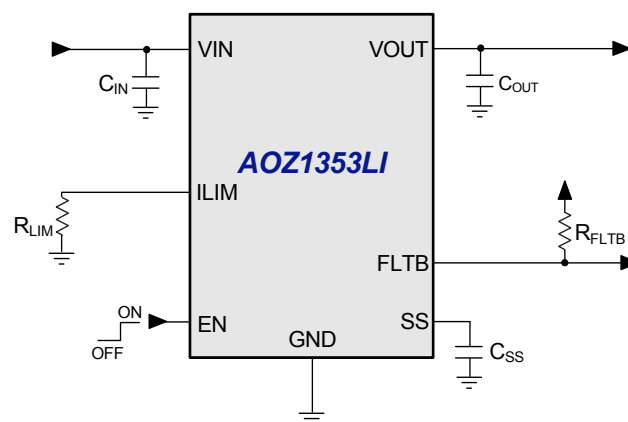

Ordering Information

Part Number	Fault Recovery	Short Circuit Protection Response	Package	Environmental
AOZ1353LI-01	Auto-Restart	Current Limit	WLCSP, 12- bumps	RoHS
AOZ1353LI-02	Latch-Off	Current Limit	WLCSP, 12- bumps	RoHS
AOZ1353LI-03	Auto-Restart	Fast Shutdown	WLCSP, 12- bumps	RoHS
AOZ1353LI-04	Latch-Off	Fast Shutdown	WLCSP, 12- bumps	RoHS



All AOS products are offered in packages with Pb-free plating and compliant to RoHS standards. Please visit www.aosmd.com/media/AOSGreenPolicy.pdf for additional information.

Pin Configuration

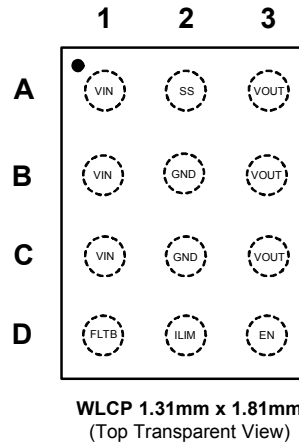

Pin Description

Pin Number	Pin Name	Pin Function
1A, 1B, 1C	VIN	Input to the current limiting switch.
1D	FLT B	Fault indicator, open-drain output, active-low when fault condition occurs.
2A	SS	Soft-start pin. Connect a capacitor C_{SS} from SS to GND to set the soft-start time or short to GND for fixed-time soft-start.
2B, 2C	GND	Ground.
2D	ILIM	Current limit threshold. Connect a resistor R_{LIM} from ILIM to GND to set the current limit threshold.
3A, 3B, 3C	VOUT	Current limiting switch output. In Type-C USB application, connect to VBUS.
3D	EN	Enable input. Active high.

Absolute Maximum Ratings

Exceeding the Absolute Maximum Ratings may damage the device.

Parameter	Rating
VOUT to GND	-0.3V to +28V
VIN, EN, ILIM, SS, FLT B to GND	-0.3V to +6V
Junction Temperature (T _J)	+150°C
Storage Temperature (T _S)	-65°C to +150°C
ESD Rating HBM/CDM	±4kV / ±1kV

Note:

- Part mounted on a 1 square inch 2-oz copper area. Double-sided PCB.

Recommended Operating Ratings

The device is not guaranteed to operate beyond the Maximum Operating Ratings.

Parameter	Rating
VIN to GND	3.4V to 5.5V
EN, FLT B to GND	0V to 5.5V
Switch Current (I _{SW})	0A to 3.5A
SS, ILIM	0V to 3.5A
Ambient Temperature (T _A)	-40°C to +85°C
Package Thermal Resistance ⁽¹⁾	84°C/W

Electrical Characteristics

T_A = 25°C, V_{IN} = 5V, SS pin is shorted to GND unless otherwise specified.

Symbol	Parameter	Conditions	Min.	Typ.	Max.	Units
General						
V _{IN}	Input Supply Voltage		3.4		5.5	V
V _{UVLO_R}	Under-voltage Lockout Threshold	VIN rising	3	3.25	3.35	V
V _{UVLO_HYS}	Under-voltage Lockout Hysteresis	VIN falling		150		mV
I _{IN_ON}	Input Quiescent Current	VIN = 5V, I _{OUT} = 0A, EN = 5V		125		µA
I _{IN_OFF}	Input Shutdown Current	VIN = 5V, EN = 0V		6		µA
R _{ON}	Switch On Resistance	VIN = 5V, I _{OUT} = 1A		32		mΩ
V _{EN_H}	Enable Input Logic High Threshold	EN rising	1.4			V
V _{EN_L}	Enable Input Logic Low Threshold	EN falling			0.4	V
I _{EN_BIAS}	Enable Input Bias Current	EN = 1.8V		1	1.5	µA
V _{FLT B_LO}	FLT B Pull-down Voltage	I _{SINK} = 3mA			0.3	V
Over-Voltage Protection						
V _{OVLO_R}	Over-voltage Lockout Threshold	VIN rising	5.5	5.75	6	V
V _{OVLO_F}		VIN falling		5.5		
V _{OVLO_HYS}	Over-voltage Lockout Hysteresis			250		mV
T _{DELAY_OVP}	OVP Turn-Off Delay	Time between VIN rises from 5V to 6.5V and power switch turns off		2		µs
Over-Current Protection						
I _{LIM}	Current Limit Threshold	VOUT = 5V, R _{LIM} = 4.02kΩ	3.08	3.5	3.92	A
		VOUT = 5V, R _{LIM} = 14.3kΩ	0.9	1	1.1	
		VOUT = 5V, R _{LIM} = 29.4kΩ	0.45	0.5	0.55	
T _{OCP_FLT B}	Over-Current Flag Delay	From I _{OUT} ≥ I _{LIM} to FLT B pulled low		12		ms
Reverse-Current Blocking						
V _{T_RCB}	RCB Protection Trip Point	VOUT-VIN, VOUT rising		20		mV
V _{R_RCB}	RCB Protection Release Trip Point	VIN-VOUT, VOUT falling		40		mV
V _{RCB_HYS}	RCB Hysteresis	V _{T_RCB} + V _{R_RCB}		60		mV
T _{RCB}	RCB Response Time			0.5		µs

Electrical Characteristics

$T_A = 25^\circ\text{C}$, $V_{IN} = 5\text{V}$, SS pin is shorted to GND unless otherwise specified.

Symbol	Parameter	Conditions	Min.	Typ.	Max.	Units
Thermal Shutdown						
T_{SD}	Thermal Shutdown Threshold	Temperature rising		140		°C
T_{SD_HYS}	Thermal Shutdown Hysteresis	Temperature falling		20		
Dynamic Characteristics						
T_{D_ON}	Turn-On Delay Time (From VEN 50% to VOUT=0.5V)	$V_{IN} = 5\text{V}$, $R_L = 100\Omega$, $C_{OUT} = 1\mu\text{F}$, $C_{SS} = 1\text{nF}$, $R_{LIM} = 14.3\text{k}\Omega$		3		ms
T_{ON}	Turn-ON Time (VOUT from 0.5V to 4.5V)	$V_{IN} = 5\text{V}$, $R_L = 100\Omega$, $C_{OUT} = 1\mu\text{F}$, SS Pin grounded, $R_{LIM} = 14.3\text{k}\Omega$		3.4		ms

Functional Block Diagram

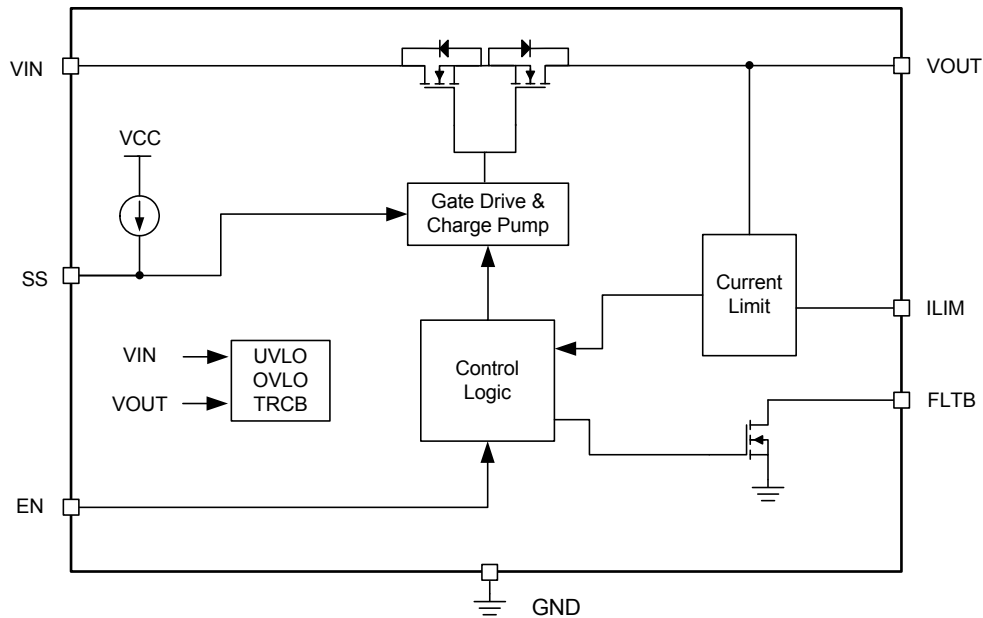

Timing Diagrams

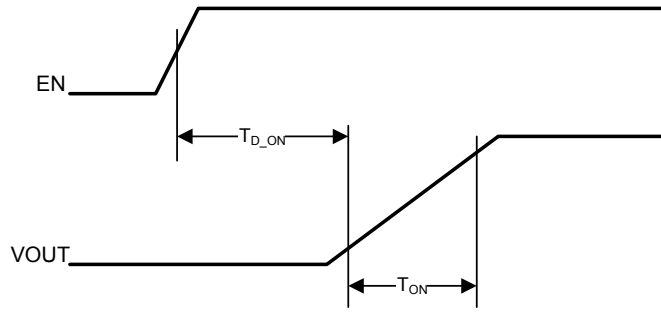

Turn-on Delay and Turn-on Time

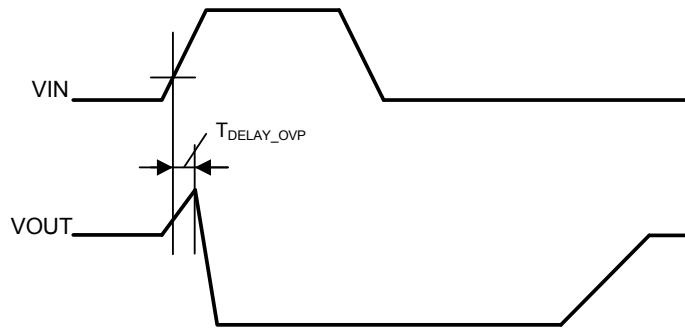

OVP Delay and Recovery

Typical Characteristics

$T_A=25^{\circ}\text{C}$, $V_{IN}=5\text{V}$, device option Auto-Restart, $C_{IN}=76\mu\text{F}$ (nominal), $C_{OUT}=9.4\mu\text{F}$ (nominal), $R_{LIM}=4.75\text{k}\Omega$, unless otherwise noted. "Offset" or "ofst" in the scope shots below means vertical position of the channel's ground reference relative to the mid horizontal line.

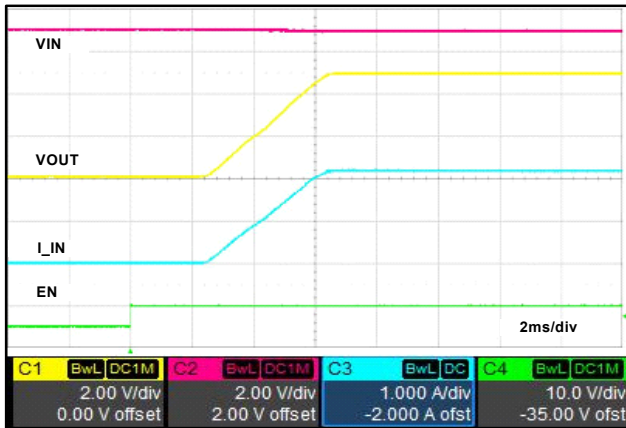

Figure 1. Soft Start by EN (LOAD = 2.3Ω)

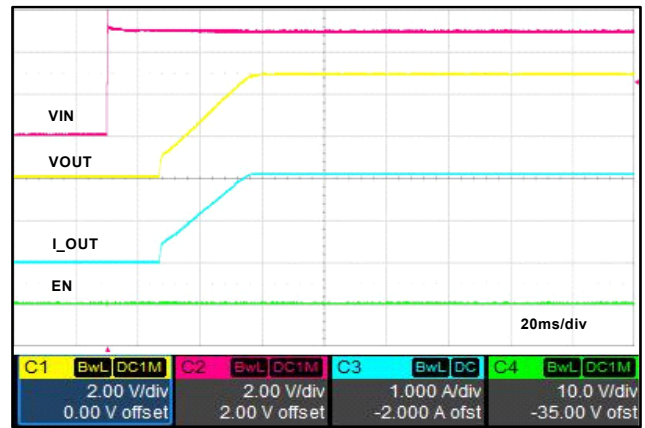

Figure 2. Soft Start by Toggling VIN (LOAD = 2.4Ω)

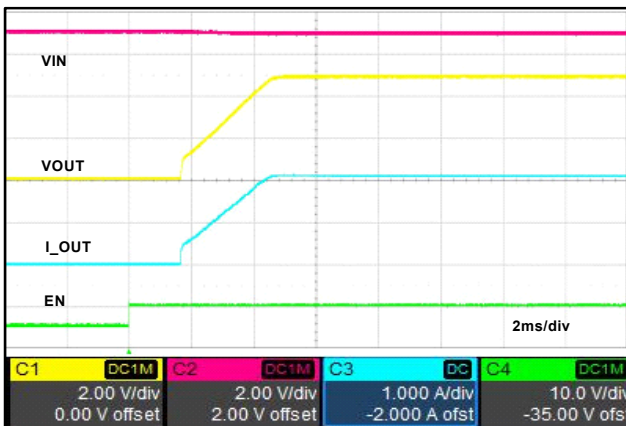

Figure 3. Soft Start by EN
(LOAD = 2.4Ω, Device Option -03)

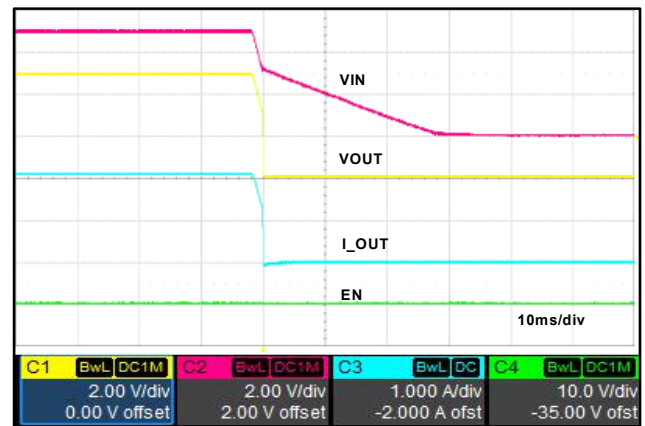

Figure 4. Shutdown by Toggling VIN (LOAD = 2.4Ω)

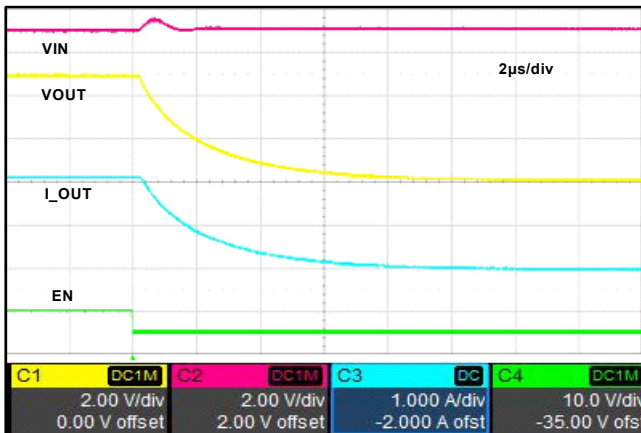

Figure 5. Shutdown by EN (LOAD = 2.4Ω)

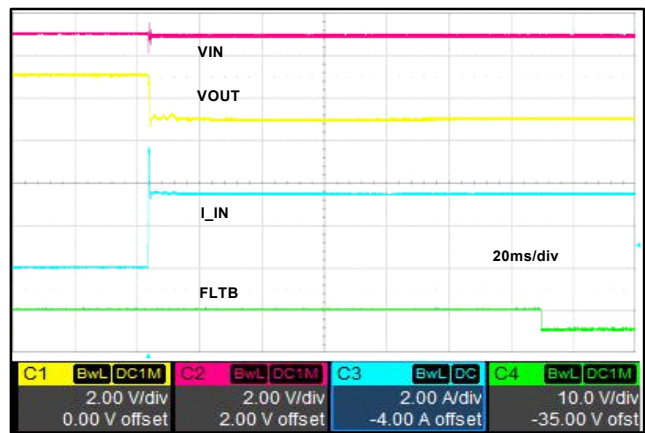

Figure 6. Over Current Protection
(LOAD = 1.2Ω, Plugged in)

Typical Characteristics (continued)

$T_A=25^{\circ}\text{C}$, $V_{IN}=5\text{V}$, device option Auto Restart, $C_{IN}=76\mu\text{F}$ (nominal), $C_{OUT}=9.4\mu\text{F}$ (nominal), $R_{LIM}=4.75\text{k}\Omega$, unless otherwise noted. "Offset" or "ofst" in the scope shots below means vertical position of the channel's ground reference relative to the mid horizontal line.

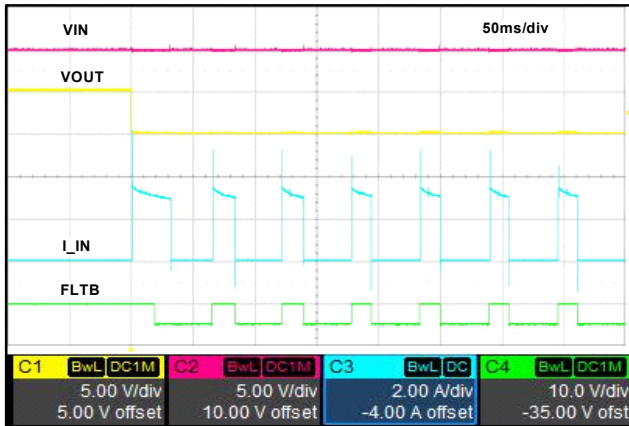

Figure 7. Short Circuit Protection, Thermal Shutdown and Auto Retry (Device Option -03)

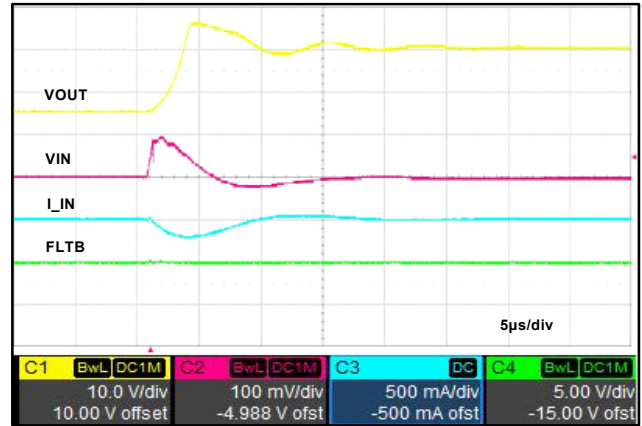

Figure 8. Reverse Current Blocking (VOUT Shorted to 20V)

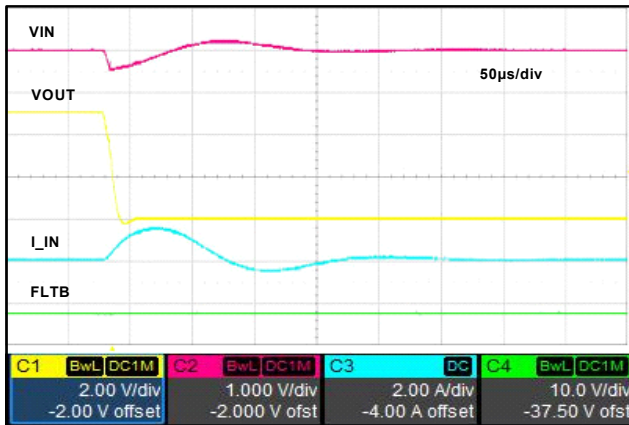

Figure 9. Short Circuit Protection (Device Option -03)

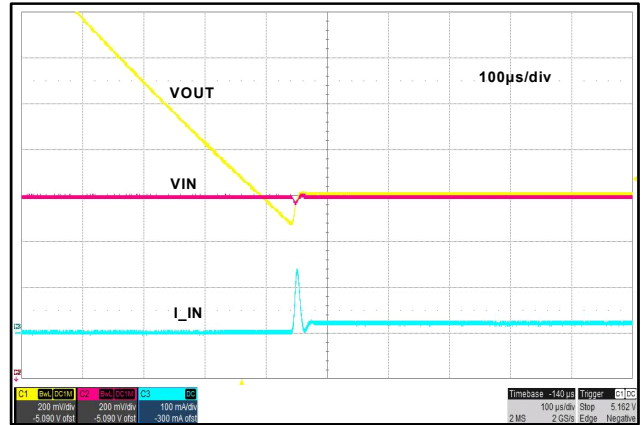

Figure 10. Recovery from Reverse Current Blocking

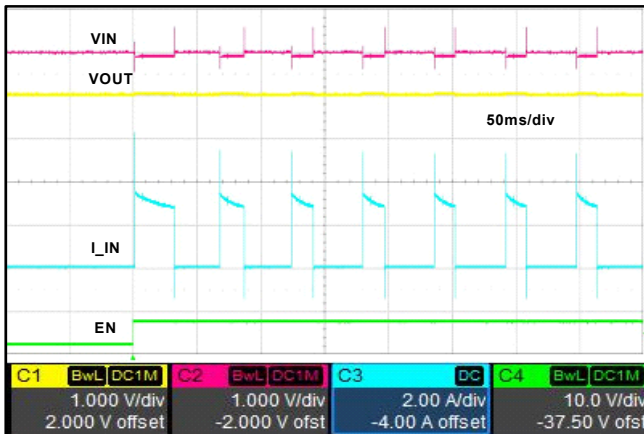

Figure 11. Starting Up into Shorted Output (Device Option -03)

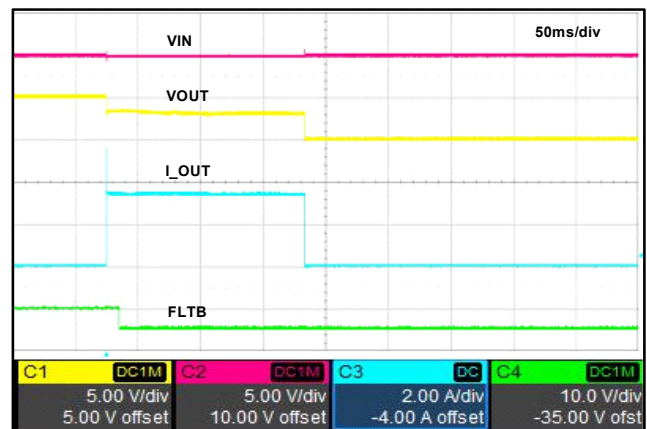

Figure 12. Over Current and Thermal Protection (LOAD = 1.2Ω, Plugged in, Device Option -04)

Typical Characteristics (continued)

$T_A=25^{\circ}\text{C}$, $V_{IN}=5\text{V}$, device option Auto-restart, $C_{IN}=76\mu\text{F}$ (nominal), $C_{OUT}=9.4\mu\text{F}$ (nominal), $R_{LIM}=4.75\text{k}\Omega$, unless otherwise noted. "Offset" or "ofst" in the scope shots below means vertical position of the channel's ground reference relative to the mid horizontal line.

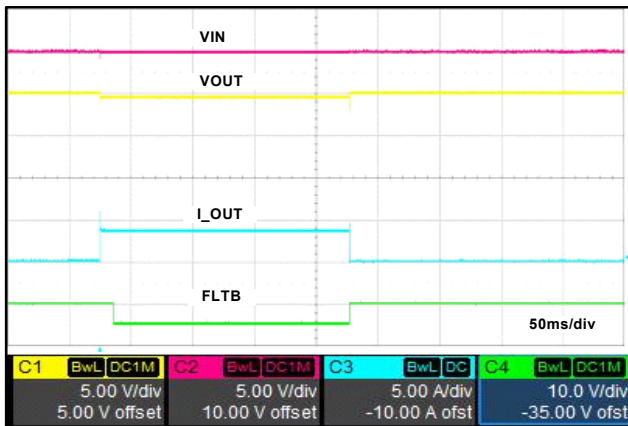

Figure 13. Short Duration Over Current
w/o causing Thermal Shutdown
(LOAD = 1.2Ω Applied for 200ms, Device Option -04)

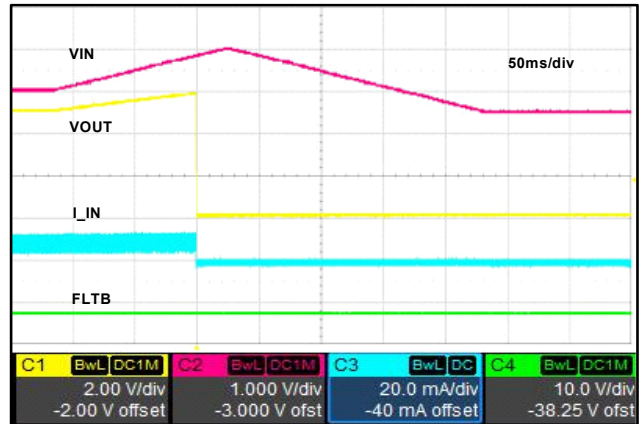

Figure 14. Over-Voltage Protection
(LOAD = 938Ω - Device Option -04)



Figure 15. Short Circuit Protection
(No Load, Device Option -04)

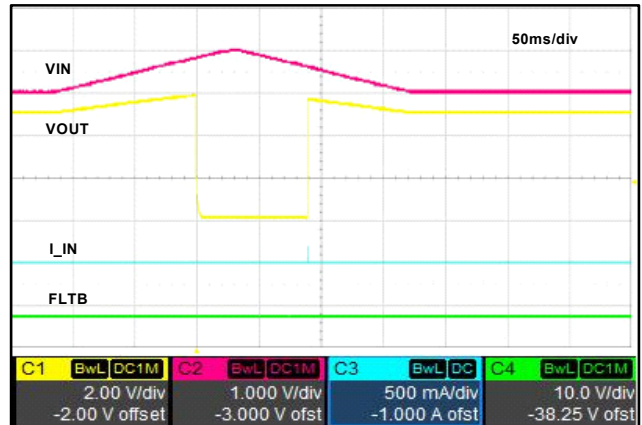

Figure 16. Over-Voltage Protection and Recovery
(LOAD = $10\text{k}\Omega$, Device Option -03)

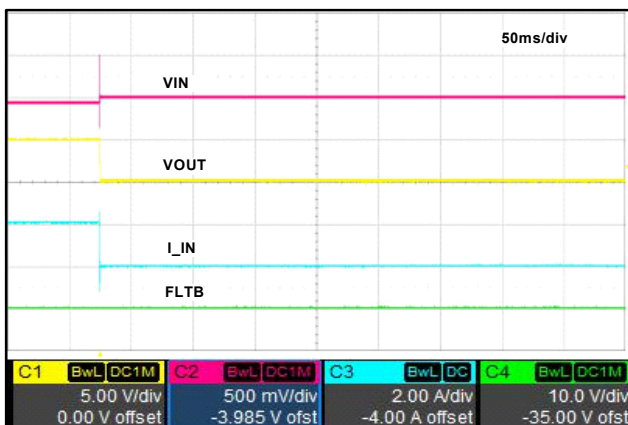

Figure 17. Short Circuit Protection
(LOAD = 2.5Ω , Device Option -04)

Typical Characteristics

$T_A = 25^\circ\text{C}$, $V_{IN} = 5\text{V}$ unless otherwise specified.

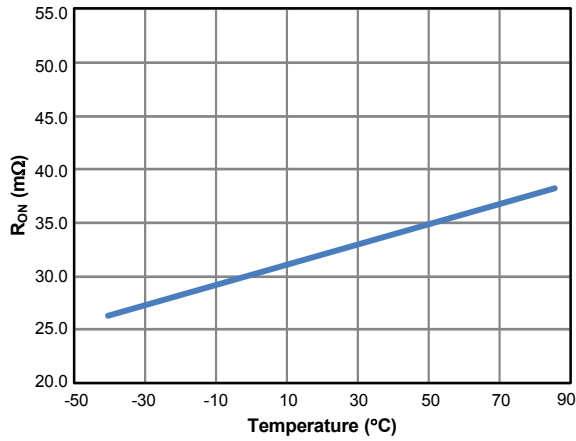

Figure 18. R_{ON} vs. Temperature

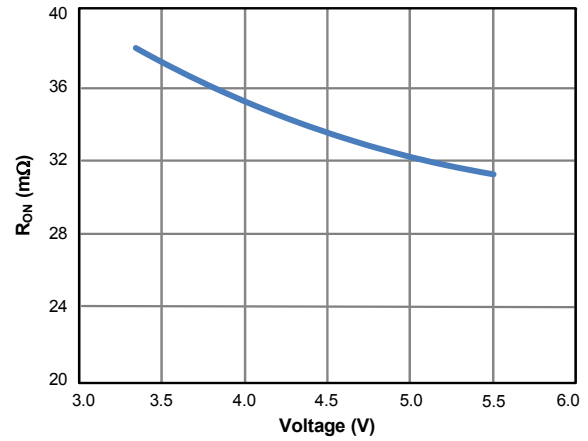

Figure 19. R_{ON} vs. Input Voltage

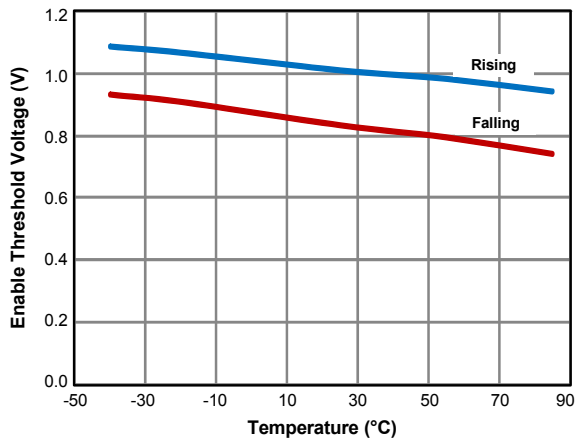

Figure 20. EN Threshold vs. Temperature

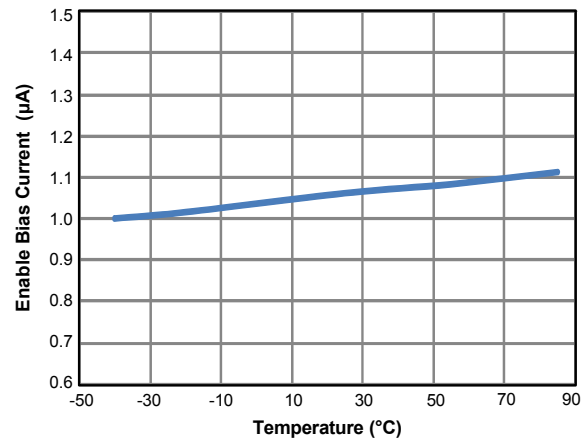

Figure 21. EN Bias Current vs. Temperature

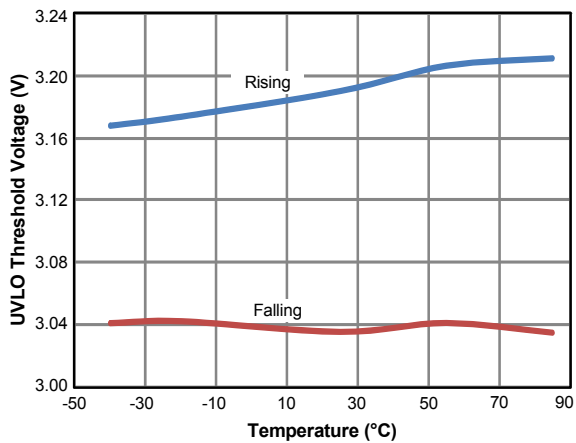

Figure 22. UVLO Threshold vs. Temperature

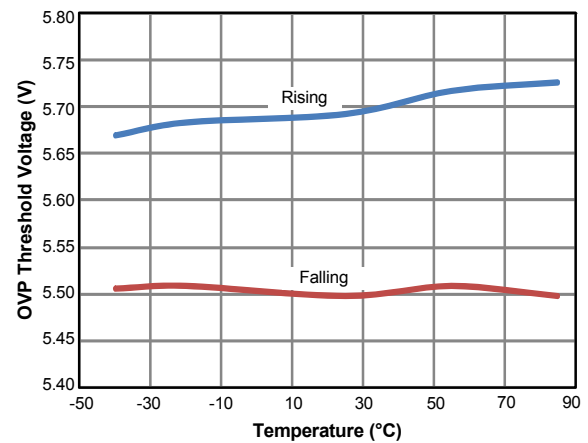

Figure 23. OVP Threshold vs. Temperature

Typical Characteristics (Continued)

$T_A = 25^\circ\text{C}$, $V_{IN} = 5\text{V}$ unless otherwise specified.

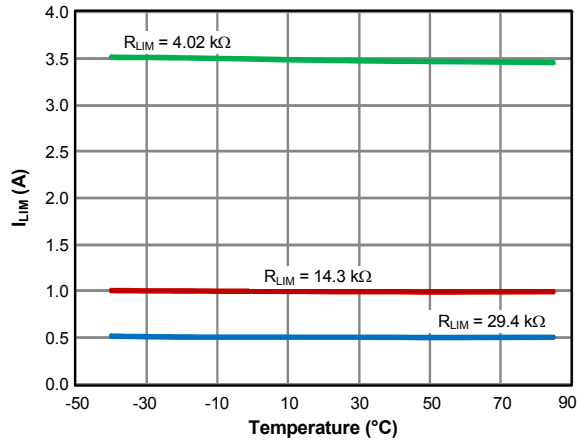

Figure 24. Current Limit Threshold vs. Temperature

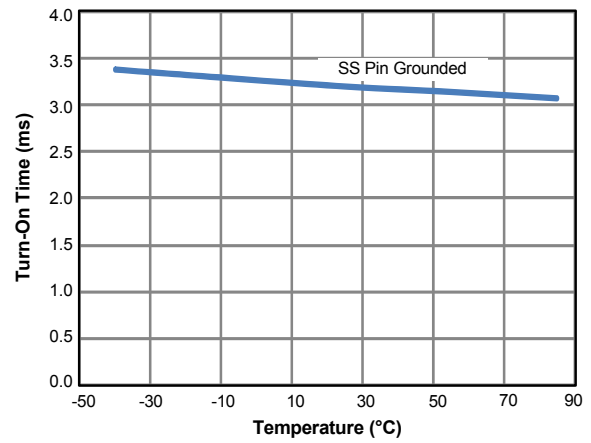

Figure 25. Turn-On Time vs. Temperature

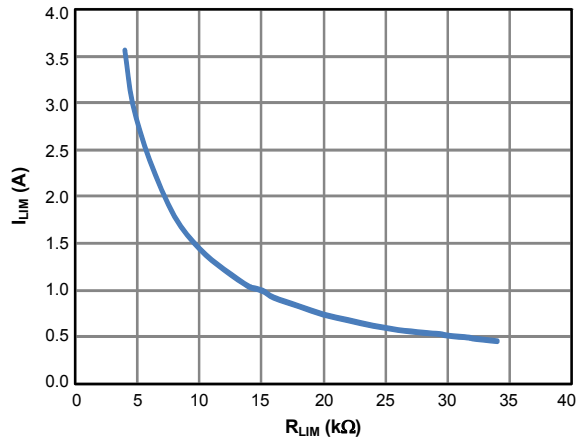

Figure 26. Current Limit vs. R_{LIM}

Functional Description

The AOZ1353LI is a current limited power switch with over-voltage, over-current, reverse-current and thermal shutdown protections. The VOUT pin is rated 28V. The operating input voltage ranges from 3.4V to 5.5V. The switch current is rated up to 3.5A.

The device has true reverse-current blocking features that will prevent undesired current flow from output to its input in either enabled or disabled state.

Enable

The EN pin is the ON/OFF control for the power switch. The device is enabled when EN pin is high and not in under-voltage lockout state. The EN pin must be driven to a logic high or logic low state to guarantee operation. While disabled, the AOZ1353LI draws less than 1µA from supply.

For AOZ1353LI-02, -04 toggle EN pin to restart the device and clear fault flag after device latches off due to fault.

Input Under-Voltage Lockout (UVLO)

The under-voltage lockout (UVLO) circuit monitors the input voltage. The power switch is only allowed to turn on when input voltage is higher than UVLO threshold. Otherwise the switch is off.

Over-Voltage Protection (OVP)

The voltages at VIN terminal is constantly monitored once the device is enabled. In case input voltage exceeds the over-voltage lockout threshold (V_{OVLO_R}), the power switch is either turned off immediately or kept off, depending on its initial state. AOZ1353LI-01 and -03 can restart when VIN drops below V_{OVLO_F} .

Programmable Current Limit and Over-Current Protection (OCP)

The AOZ1353LI implemented current limit to ensure that the current through the switch does not exceed current limit threshold set by the external resistor R_{LIM} .

The current limit threshold can be estimated using the equation below:

$$I_{LIM} = 14300/R_{LIM} \text{ (A)}$$

For example, for 1A current limit threshold, a 14.3kΩ R_{LIM} resistor should be selected. 1% resistor is recommended for R_{LIM} .

AOZ1353LI continuously limits the output current when output is overloaded, Under current-limiting, FLT is pulled low after delay (T_{OCP_FLT}). Severe overload causes power dissipation and die temperature to increase and may trigger thermal shutdown.

Short Circuit Protection (SCP)

AOZ1353LI offers protection against output short circuit. In case of AOZ1353LI-01, -02 options, when a hard short occurs while enabled, there will be a sudden increase in output current that can cause the input to drop momentarily before the part enters current limit. The device will remain in current limit indefinitely until the device is disabled or enters thermal shutdown.

In contrast, AOZ1353LI-03, -04 options have fast SCP comparator that will immediately shut down the pass device to minimize input voltage drop when a short occurs. Part will restart the soft start after 3ms to resume normal operation. If the short stills persists the device will enter current limit until disabled or enters thermal shutdown.

True Reverse-Current Blocking Protection (TRCB)

True reverse-current blocking prevents undesired current flow from output to input when power switch is in either on or off state. When device is enabled, power switch is quickly turned off whenever output voltage is higher than input voltage. The power switch is turned on again when output voltage falls below input by 70mV.

Fast Recovery

Once RCB event is removed, power switch turns on again quickly. The recovery time is less than 100µs.

Thermal Shutdown Protection

Thermal shutdown protects device from excessive temperature. The power switch is turned off when the die temperature reaches thermal shutdown threshold of 140°C. There is a 20°C hysteresis. For AOZ1353LI-01, -03 power switch is allowed to turn on again if die temperature drops below approximately 120°C.

Soft Start

The AOZ1353LI has soft-start circuitry to limit in-rush current due to large capacitive load. By default the turn-on time is 3.4ms when SS pin is connected to GND.

Fast turn-on time can be set by adding an external capacitor C_{SS} between SS pin and ground. The capacitor value is selected using Table 1.

Table 1. Turn-On Time Settings by C_{SS}

C _{SS} (nF)	Turn-On Time (ms)
1	0.3
1.2	0.4
2.2	0.8
3.3	1.2
4.7	1.7
5.6	1.9
6.8	2.4
8.2	2.8
10	3.2
12	3.4
SS pin short to GND	3.4

Startup

The device is enabled when $EN \geq V_{EN_H}$ and input voltage is above UVLO threshold. The device first checks if any fault condition exists. When no fault exists, the power switch is turned on and the output is then ramped up. Power switch is kept off if fault condition was detected.

Fault Reporting

AOZ1353LI protects itself and load from the following fault condition: over-voltage, over-current, reverse-current, and over-temperature.

The FLT_B pin is an open drain output. It is asserted low when either an over-current, or over-temperature condition occurs. The FLT_B pin becomes high impedance when the fault conditions are removed. A pull-up resistor (R_{FLT_B}) must be connected between FLT_B to 5V to provide a logic signal.

When thermal shutdown is activated, FLT_B is pulled low immediately to report fault condition to host. FLT_B is pulled high once fault is removed.

In case of output overload, FLT_B pin is pulled low about 12ms (T_{OCP_FLTB}) after device is in current-limiting. For AOZ1353LI-02, -04 power switch is then turned off after another 12ms.

There is no fault reporting for UVLO, OVP and RCB event.

Auto-restart or Latch-off

AOZ1353LI-01, -03 (auto-restart version): The device will try to restart 24ms after the power switch is turned off and when OVP or thermal shutdown fault is removed.

Power switch is turned on immediately after a RCB event is removed.

AOZ1353LI-02, -04 (latch-off version): The device keeps off even after the fault condition is removed. Power switch can only be turned on again by either toggle EN pin or recycle the input supply.

Input Capacitor Selection

The input capacitor prevents large voltage transients from appearing at the input, and provides the instantaneous current needed each time the switch turns on to charge output capacitors and to limit input voltage drop. It is also to prevent high-frequency noise on the power line from passing through to the output. The input capacitor should be located as close to the pin as possible. A minimum of 10µF ceramic capacitor should be used. However, higher capacitor value is strongly recommended to further reduce the transient voltage drop at the input.

Output Capacitor Selection

The output capacitor acts in a similar way. Also, the output capacitor has to supply enough current for a large load that it may encounter during system transient. This bulk capacitor must be large enough to supply fast transient load in order to prevent the output from dropping.

There is an upper limit for output capacitor for AOZ1353LI to ensure the output capacitor can be charged fully during start-up. This upper limit is set by the current limit level and soft-start time.

$$C_{out} = I_{LIM} \times (T_{ON} / VIN)$$

Power Dissipation Calculation

Calculate the power dissipation for normal load condition using the following equation:

$$Power\ Dissipated = R_{ON} \times (I_{OUT})^2$$

The worst case power dissipation occurs when the load current hits the current limit due to over-current. The power dissipation can be calculated using the following equation:

$$Power\ Dissipated = (VIN - VOUT) \times I_{LIM}$$

Layout Guidelines

Good PCB layout is important for improving the thermal and overall performance of AOZ1353LI. To optimize the switch response time to output short-circuit conditions, keep all traces as short as possible to reduce the effect of unwanted parasitic inductance. Place the input and output bypass capacitors as close as possible to the VIN and VOUT pins. The input and output PCB traces should be as wide as possible for the given PCB space. Use a ground plane to enhance the power dissipation capability of the device.

Package Dimensions, 1.81x1.31 Array WLCSP_12L

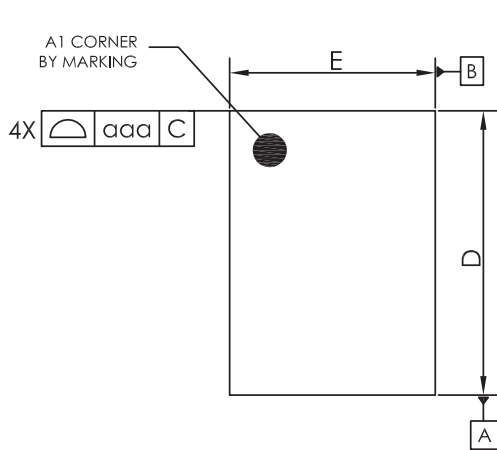

TOP VIEW

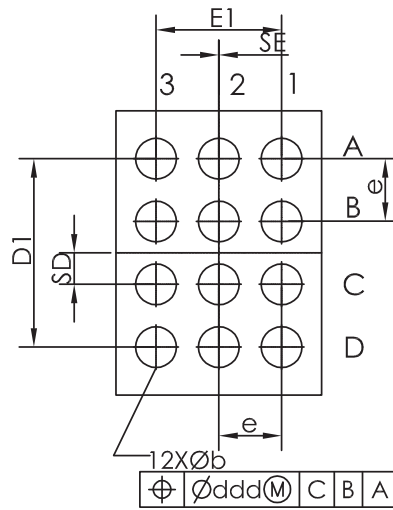

BOTTOM VIEW

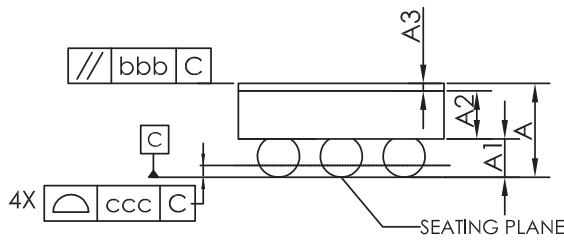

SIDE VIEW

SYMBOL	DIMENSION IN MM			DIMENSION IN INCH		
	MIN.	NOM.	MAX.	MIN.	NOM.	MAX.
A	0.445	0.495	0.545	0.0175	0.0195	0.0215
A1	0.188	0.208	0.228	0.0074	0.0082	0.0090
A2	0.240	0.265	0.290	0.0094	0.0104	0.0114
A3	0.012	0.022	0.032	0.0005	0.0009	0.0013
D	1.785	1.810	1.835	0.0703	0.0713	0.0722
D1	1.150	1.200	1.250	0.0453	0.0472	0.0492
E	1.285	1.310	1.335	0.0506	0.0516	0.0526
E1	0.750	0.800	0.850	0.0295	0.0315	0.0335
b	0.230	0.260	0.290	0.0091	0.0102	0.0114
e	0.400 BSC.			0.0157 BSC.		
SD	0.200 BSC.			0.0079 BSC.		
SE	0.000 BSC.			0.0000 BSC.		
Tol. of Form & Position			Tol. of Form & Position			
aaa	0.05			0.0020		
bbb	0.05			0.0020		
ccc	0.05			0.0020		
ddd	0.05			0.0020		

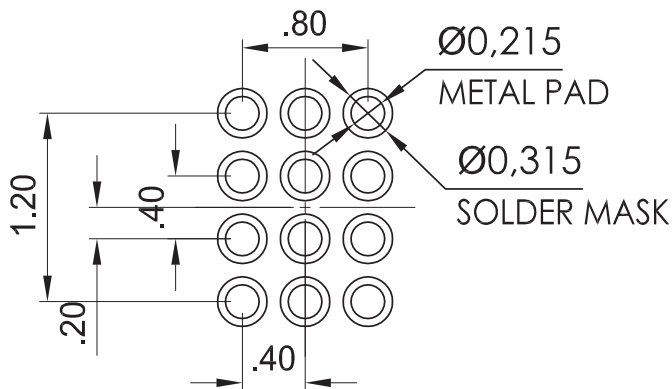

RECOMMENDED LAND PATTERN

NOTES:

- 1.NO JEDEC REGISTRATION APPLIES.
- 2.DIMENSIONS ARE IN MILLIMETERS.
- 3.DIMENSIONS AND TOLERANCES PER PROCESS CAPABILITY
- 4.DATUM C IS DEFINED BY THE SPHERICAL CROWNS OF THE BALLS.

Tape and Reel Drawing, 1.81x1.31 Array WLCSP_12L

Carrier Tape

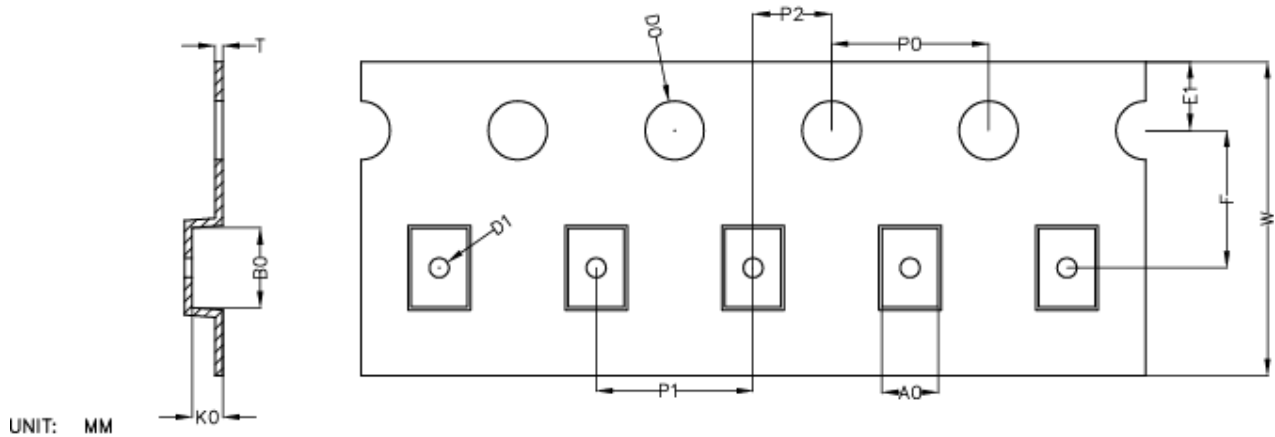

UNIT: MM

A0	B0	K0	D0	D1	W	E1	F	P0	P1	P2	T
1.43 ±0.05	2.00 ±0.05	0.78 ±0.05	1.50 +0.10 -0.00	0.50 ±0.05	8.00 +0.30 -0.10	1.75 ±0.10	3.50 ±0.05	4.00 ±0.10	4.00 ±0.10	2.00 ±0.05	0.20 ±0.02

REEL

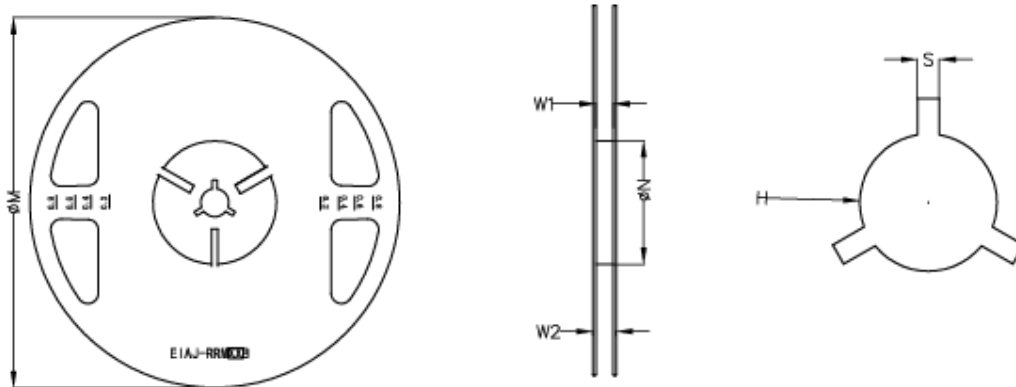

UNIT: MM

TAPE SIZE	REEL SIZE	M	N	W1	W2	H	S
8	ø180	ø180.0 +0.0 -1.0	ø60.0 +1.0 -0.0	9.0 +1.0 -0.0	11.4 +1.0 -0.0	ø13.0 ±0.2	2.0 ±0.5

TAPE

Leader / Trailer & Orientation

Unit Per Reel:
3000pcs

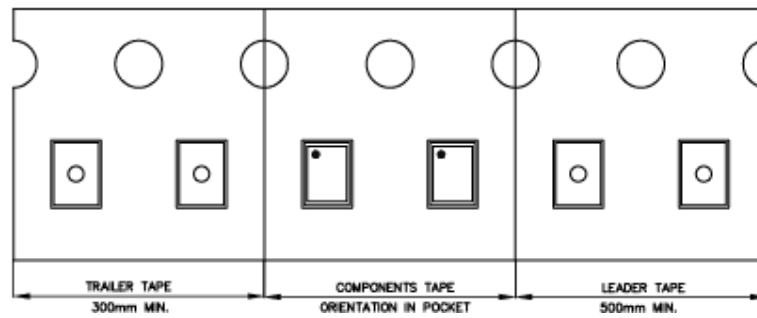

Part Marking

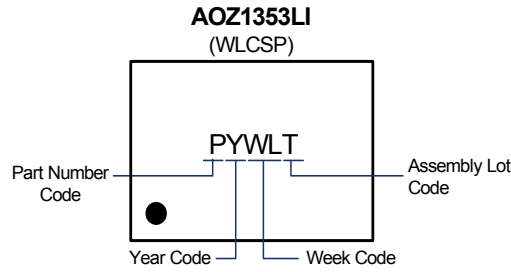

Part Number	Description	Code
AOZ1353LI-01	Green Product	C
AOZ1353LI-02	Green Product	D
AOZ1353LI-03	Green Product	G
AOZ1353LI-04	Green Product	H

LEGAL DISCLAIMER

Applications or uses as critical components in life support devices or systems are not authorized. AOS does not assume any liability arising out of such applications or uses of its products. AOS reserves the right to make changes to product specifications without notice. It is the responsibility of the customer to evaluate suitability of the product for their intended application. Customer shall comply with applicable legal requirements, including all applicable export control rules, regulations and limitations.

AOS' products are provided subject to AOS' terms and conditions of sale which are set forth at:

[http://www.aosmd.com/terms and conditions of sale](http://www.aosmd.com/terms_and_conditions_of_sale)

LIFE SUPPORT POLICY

ALPHA AND OMEGA SEMICONDUCTOR PRODUCTS ARE NOT AUTHORIZED FOR USE AS CRITICAL COMPONENTS IN LIFE SUPPORT DEVICES OR SYSTEMS.

As used herein:

1. Life support devices or systems are devices or systems which, (a) are intended for surgical implant into the body or (b) support or sustain life, and (c) whose failure to perform when properly used in accordance with instructions for use provided in the labeling, can be reasonably expected to result in a significant injury of the user.
2. A critical component in any component of a life support, device, or system whose failure to perform can be reasonably expected to cause the failure of the life support device or system, or to affect its safety or effectiveness.

单击下面可查看定价，库存，交付和生命周期等信息

[>>AOS\(万代\)](#)