

General Description

The AOZ8033 is an 4-line device integrating EMI filtering with ESD protection for each line. It is designed to suppress unwanted EMI/RFI signals and provide electrostatic discharge (ESD) protection in portable electronic equipment. This state-of-the-art device utilizes AOS leading edge Trench Vertical Structure [TVS]²™ technology for superior clamping performance and filter attenuation over the full operating display range. The AOZ8033 has been optimized for protection of color LCD displays and CCD camera lines in cellular phones and other portable consumer electronic devices.

The AOZ8033 consists of four identical circuits comprised of TVS diodes for ESD protection, and a resistor–capacitor network for EMI/RFI filtering. A series resistor value of 100Ω and a capacitance value of 28pF are used to achieve -35dB minimum attenuation from 800MHz to 3.0GHz. The TVS diodes provide effective suppression of ESD voltages in excess of ±20kV (air discharge) and ±20kV (contact discharge). This exceeds IEC 61000-4-2, level 4 ESD immunity test.

The AOZ8033 comes in an RoHS compliant, 1.2mm x 1.8mm, 0.4mm pitch DFN package and is rated over a -40°C to +85°C ambient temperature range.

Features

- 4 lines for EMI filtering and ESD protection:
 - Exceeds IEC 61000-4-2, level 4 (ESD) immunity test
 - ±20kV (air discharge) and ±20kV (contact discharge)
- Trench Vertical Structure [TVS]²™ based technology used to achieve excellent ESD clamping & filter performance over the full operating display range
- Filter performance: -35db attenuation from 800MHz to 3.0GHz
- Low operating voltage: 5.0V
- Capacitance stability over wide range of voltages and temperatures
- DFN package: 1.2mm x 1.8mm, 0.4mm pitch
- Pb-Free device

Applications

- EMI filtering and ESD protection for data lines
- LCD displays, camera interface, I/O interface
- Portable handheld devices, cell phones, PDA phones



Typical Application

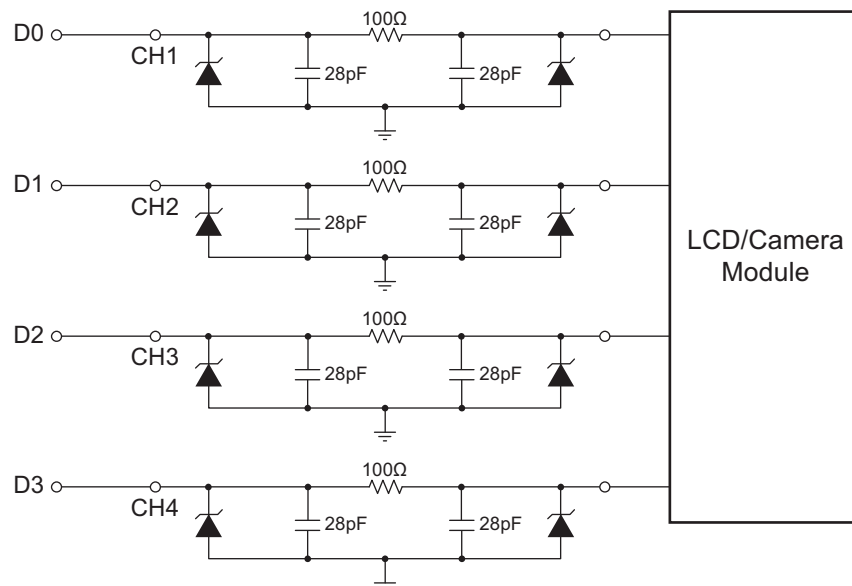

Figure 1

Ordering Information

Part Number	Ambient Temperature Range	Package	Environmental
AOZ8033DIL	-40°C to +85°C	DFN-8	RoHS Compliant Green Product



All AOS products are offered in packages with Pb-free plating and compliant to RoHS standards. Parts marked as Green Products (with "L" suffix) use reduced levels of Halogens, and are also RoHS compliant. Please visit www.aosmd.com/web/quality/rohs_compliant.jsp for additional information.

Pin Configuration

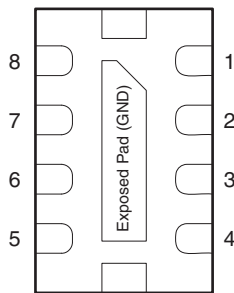

DFN-8
(Bottom View)

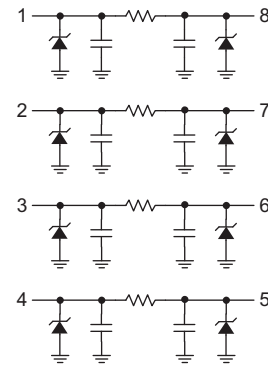

Top View

Pin Description

Pin Number	Pin Name	Pin Function
1, 8	CH 1	Channel 1 Connections
2, 7	CH 2	Channel 2 Connections
3, 6	CH 3	Channel 3 Connections
4, 5	CH 4	Channel 4 Connections
Exposed Pad	GND	Common Ground Connection

Absolute Maximum Ratings

Exceeding the Absolute Maximum ratings may damage the device.

Parameter	Rating
Storage Temperature (T _S)	-65°C to +150°C
ESD Rating per IEC61000-4-2, contact ⁽¹⁾	±20kV
ESD Rating per IEC61000-4-2, air ⁽¹⁾	±20kV
ESD Rating per Human Body Model ⁽²⁾	±30kV

Notes:

- IEC 61000-4-2 discharge with C_{Discharge} = 150pF, R_{Discharge} = 330Ω.
- Human Body Discharge per MIL-STD-883, Method 3015 C_{Discharge} = 100pF, R_{Discharge} = 1.5kΩ.

Electrical Characteristics

T_A = 25°C unless otherwise specified.

Symbol	Parameter	Conditions	Min.	Typ.	Max.	Units
V _{RWM}	Reverse Working Voltage	⁽³⁾			5.0	V
V _{BR}	Reverse Breakdown Voltage	I _T = 1mA ⁽⁴⁾	6	7	8	V
I _R	Reverse Leakage Current	V _{RWM} = 3.3V			0.1	μA
V _{CL}	Signal Clamp Voltage	I _{LOAD} = 1A, positive clamp ⁽⁵⁾⁽⁶⁾			7.00	V
		I _{LOAD} = 1A, negative clamp ⁽⁵⁾⁽⁶⁾			-3.00	
		I _{LOAD} = 5A, positive clamp ⁽⁵⁾⁽⁶⁾			8.00	
		I _{LOAD} = 5A, negative clamp ⁽⁵⁾⁽⁶⁾			-5.00	
		I _{LOAD} = 12A, positive clamp ⁽⁵⁾⁽⁶⁾			10.00	
		I _{LOAD} = 12A, negative clamp ⁽⁵⁾⁽⁶⁾			-10.00	
R _{CH}	Total Series Resistance	I _R = 20mA	90	100	110	Ω
f _C	Cut-off Frequency	Measured with 50Ω source and 50Ω load termination		90		MHz
	Attenuation from 800MHz to 3.0GHz	V _R = 0V Measured with 50Ω source and 50Ω load termination		-35		dB
	Attenuation from 800MHz to 3.0GHz	V _R = 5V Measured with 50Ω source and 50Ω load termination		-35		dB

Notes:

- The working peak reverse voltage, V_{RWM}, should be equal to or greater than the DC or continuous peak operating voltage level.
- V_{BR} is measured at the pulse test current I_T.
- Measurements performed using a 100ns Transmission Line Pulse (TLP) system.
- Guaranteed by design.

Typical Performance Characteristics

Insertion Loss Characteristics

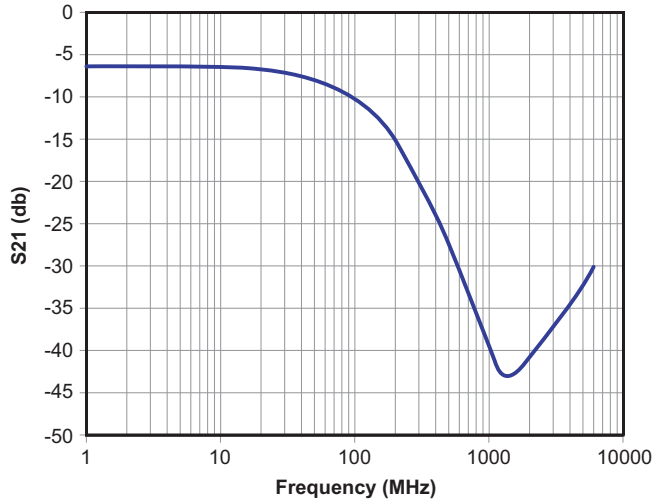

Typical Line Capacitance vs. Reverse Bias Voltage
(Normalized to Capacitance @ 2.5V)

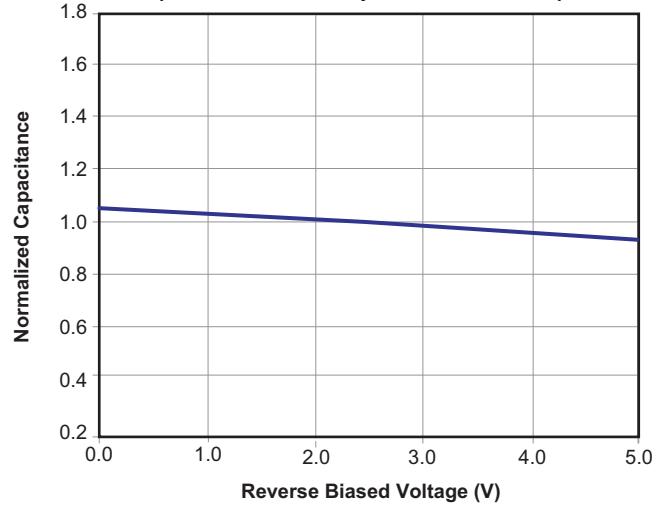

Analog Crosstalk

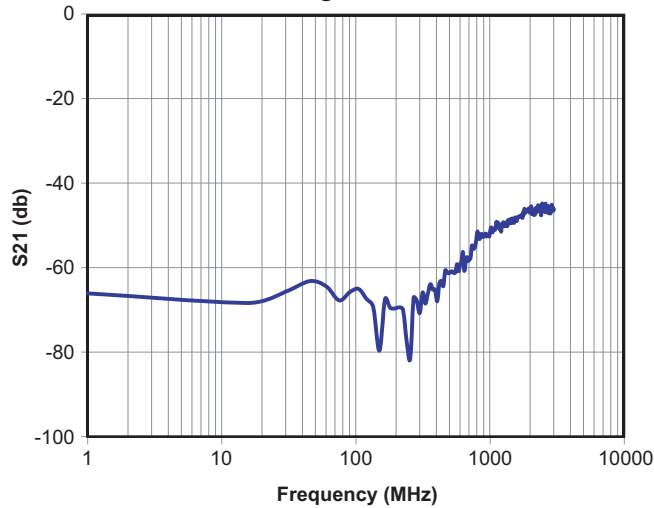

Clamping Voltage vs. Peak Pulse Current

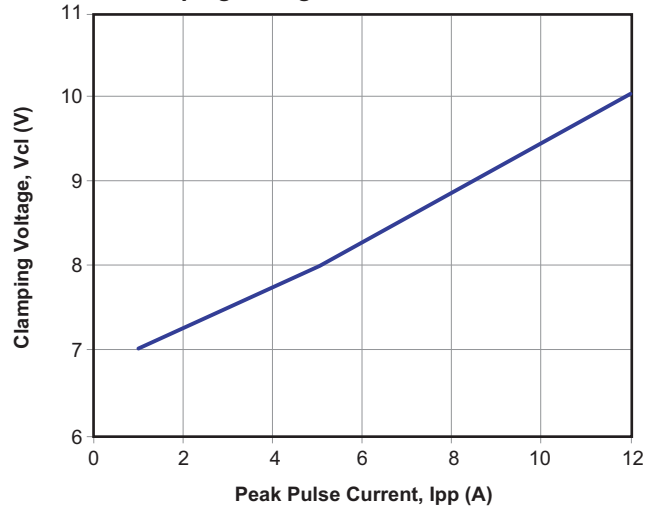

Forward Voltage vs. Forward Current

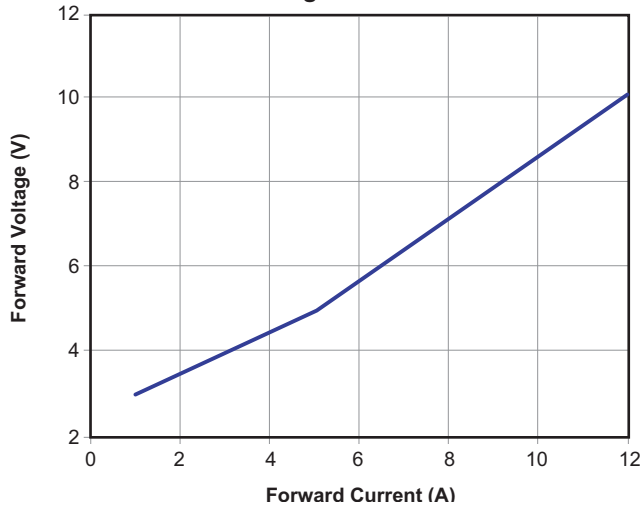

Typical Resistance vs. Temperature

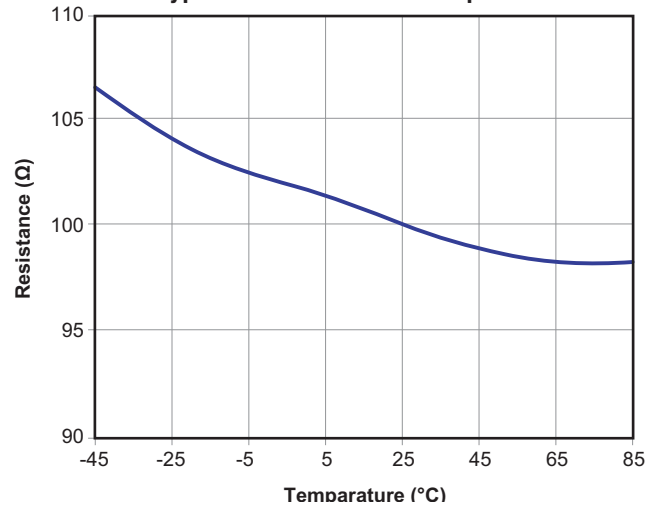

Package Dimensions, DFN 1.2 x 1.8, 8L

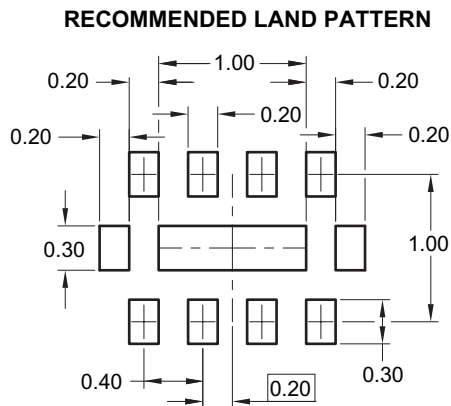
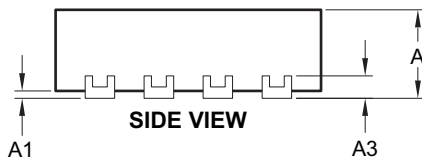
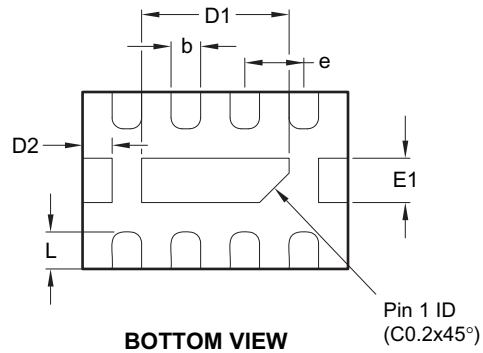
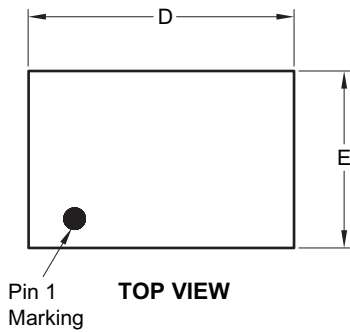

Dimensions in millimeters

Symbols	Min.	Nom.	Max.
A	0.50	0.55	0.60
A1	0.00	—	0.05
A3	0.152 Ref.		
b	0.15	0.20	0.25
D	1.75	1.80	1.85
D1	0.95	1.00	1.05
D2	0.200 Ref.		
E	1.15	1.20	1.25
E1	0.25	0.30	0.35
e	0.40 BSC		
L	0.20	0.25	0.30

Dimensions in inches

Symbols	Min.	Nom.	Max.
A	0.020	0.022	0.024
A1	0.000	—	0.002
A3	0.006 Ref.		
b	0.006	0.008	0.010
D	0.069	0.071	0.073
D1	0.037	0.039	0.041
D2	0.008 Ref.		
E	0.045	0.047	0.049
E1	0.010	0.012	0.014
e	0.016 BSC		
L	0.008	0.010	0.012

Notes:

1. Controlling dimension is millimeter, converted inch dimensions are not necessarily exact.
2. Warpage shall not exceed 0.10mm.
3. Marking is for package orientation reference only.

Tape and Reel Dimensions, DFN 1.2 x 1.8, 8L

Carrier Tape

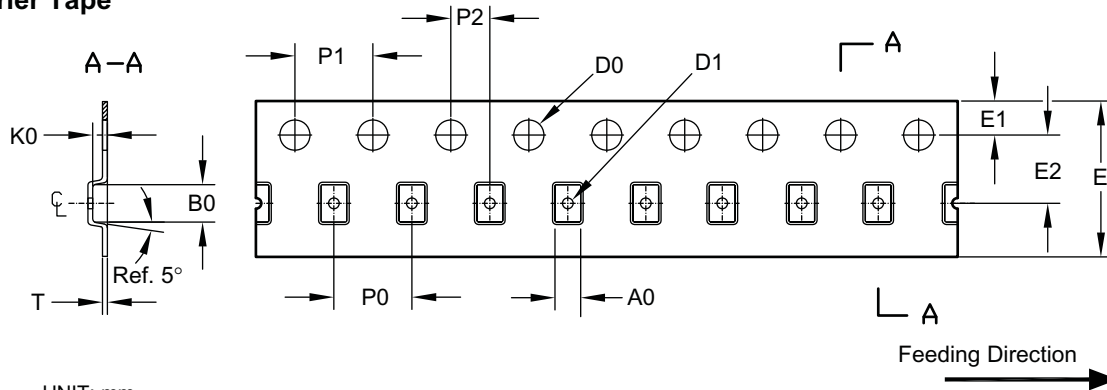

UNIT: mm

Package	A0	B0	K0	D0	D1	E	E1	E2	P0	P1	P2	T
DFN 1.8x1.2	1.32 ±0.05	1.92 ±0.05	0.75 ±0.05	ø1.55 ±0.05	ø0.55 ±0.05	8.00 +0.3/-0.1	1.75 ±0.1	3.50 ±0.05	4.00 ±0.1	4.0 ±0.1	2.0 ±0.05	0.25 ±0.05

Reel

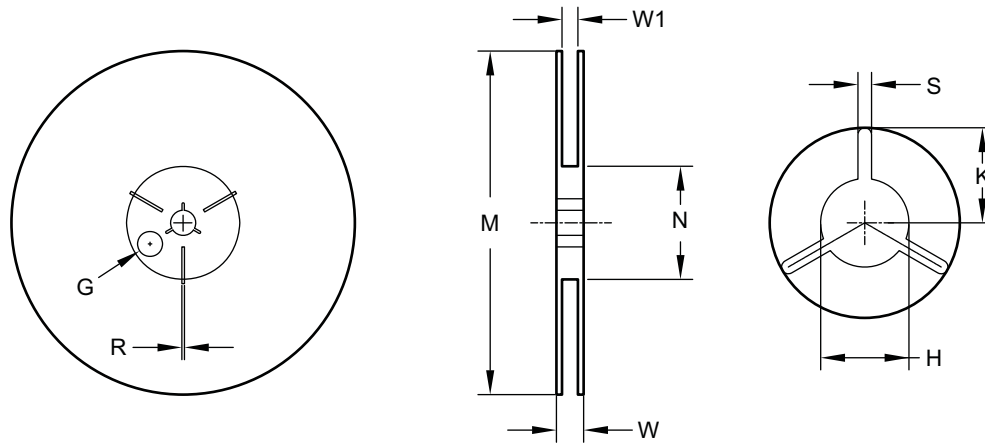

UNIT: mm

Tape Size	Reel Size	M	N	W	W1	H	S	K	G	R
8mm	ø178	ø178.0 ±1.0	ø60.0 ±1.0	11.80 ±0.5	9.0 ±0.5	ø13.0 +0.5/-0.2	2.40 ±0.10	10.25 ±0.2	ø9.8	—

Leader/Trailer & Orientation

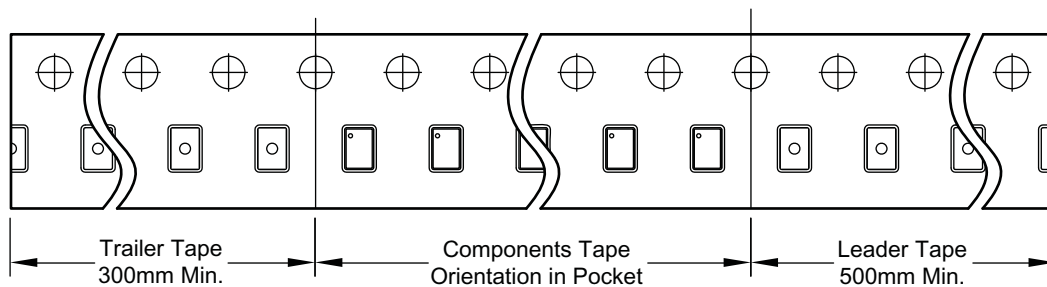

单击下面可查看定价，库存，交付和生命周期等信息

[>>AOS\(万代\)](#)