

## General Description

The AOZ8310DI is a series of one-line, high-power transient voltage suppressor designed to protect power rail/bus from surge and ESD events, with an operating voltage range from 2.5V to 36V.

This device incorporates one unidirectional TVS diode in an ultra-small 1.6mm x 1.0mm DFN package. It may be used to meet the ESD immunity requirements of IEC 61000-4-2, Level 4 ( $\pm 15\text{kV}$  air,  $\pm 8\text{kV}$  contact discharge).

The AOZ8310DI comes in an RoHS compliant package and is rated over a  $-40^{\circ}\text{C}$  to  $+125^{\circ}\text{C}$  ambient temperature range.

## Features

- Surge protection for power rail
- IEC 61000-4-5 8/20 $\mu\text{s}$  22-85A
- IEC 61000-4-2 (ESD)  $\pm 30\text{kV}$  (air and contact)
- Human body model (HBM)  $\pm 30\text{kV}$
- IEC 61000-4-4 (EFT) 80A (5/50ns)
- Peak pulse power 1100W to 1500W
- Operating voltage: 2.5V, 5V, 8V, 9V, 12V, 18V, 20V, 26V, 36V
- Green product

## Applications

- USB voltage bus
- Battery protection
- Mobile devices
- Screen panels
- Other power rails



## Typical Application

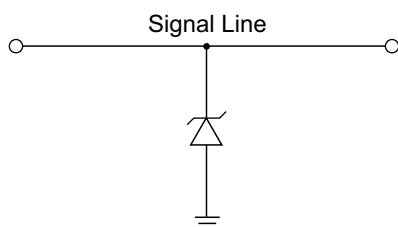

Unidirection Protection of Single Line

## Pin Configuration

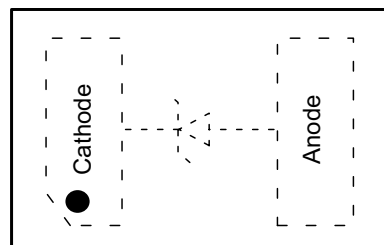

DFN1.6x1.0\_2L

## Ordering Information

Part Number	Ambient Temperature Range	Package	Environmental
AOZ8310DI-02	-40°C to +125°C	1.6mm x 1.0mm DFN-2L	Green Product
AOZ8310DI-05			
AOZ8310DI-08			
AOZ8310DI-09			
AOZ8310DI-12			
AOZ8310DI-18			
AOZ8310DI-20			
AOZ8310DI-26			
AOZ8310DI-36			



AOS Green Products use reduced levels of Halogens, and are also RoHS compliant. Please visit [www.aosmd.com/media/AOSGreenPolicy.pdf](http://www.aosmd.com/media/AOSGreenPolicy.pdf) for additional information.

## Absolute Maximum Ratings

Exceeding the Absolute Maximum ratings may damage the device.

Parameter	Rating
VP-VN	2.5V to 36V
Peak Pulse Current ( $I_{PP}$ ), $t_P = 8/20\mu s$	22A to 85A
Peak Pulse Power ( $P_{PP}$ ), $t_P = 8/20\mu s$	1100W to 1500W
Storage Temperature ( $T_S$ )	-65°C to +150°C
ESD Rating per IEC61000-4-2, Contact <sup>(1)</sup>	±30kV
ESD Rating per IEC61000-4-2, Air <sup>(1)</sup>	±30kV
ESD Rating per Human Body Model <sup>(2)</sup>	±30kV

### Notes:

- IEC 61000-4-2 discharge with  $C_{Discharge} = 150pF$ ,  $R_{Discharge} = 330\Omega$ .
- Human Body Discharge per MIL-STD-883, Method 3015  $C_{Discharge} = 100pF$ ,  $R_{Discharge} = 1.5k\Omega$ .

## Maximum Operating Ratings

Parameter	Rating
Junction Temperature ( $T_J$ )	-40°C to +125°C

Electrical Characteristics

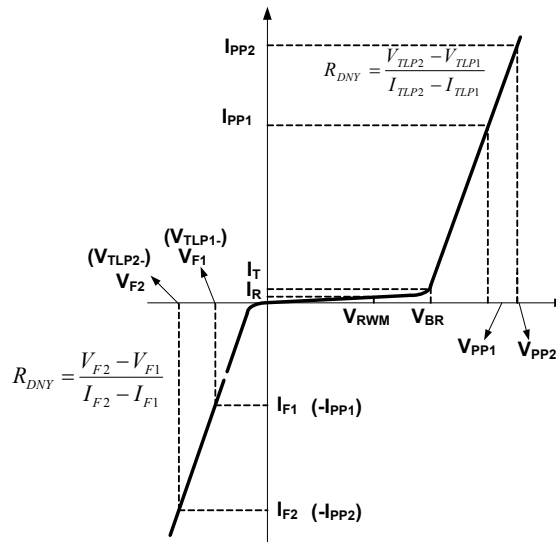

$T_A = 25^\circ\text{C}$  unless otherwise specified.

Symbol	Parameter	Condition	Min.	Typ.	Max.	Units
<b>AOZ8310DI-02</b>						
$V_{RWM}$	Reverse Working Voltage	I/O Pin-to-Ground			2.5	V
$V_{BR}$	Reverse Breakdown Voltage	$I_T = 1\text{mA}$ , I/O Pin-to-Ground	2.8	3.3	5	V
$I_R$	Reverse Leakage Current	Max. $V_{RWM}$ , I/O Pin-to-Ground		100	1000	nA
$I_{PP}$	Peak Pulse Current	IEC61000-4-5, 8/20 $\mu\text{s}$ , I/O Pin-to-Ground			75	A
$V_{CL}$	Clamping Voltage <sup>(3)</sup> (100ns Transmission Line Pulse, I/O Pin-to-Ground)	$I_{TLP} = 1\text{A}$ $I_{TLP} = -1\text{A}$		4.5 -1	6 -2	V
		$I_{TLP} = 30\text{A}$ $I_{TLP} = -30\text{A}$		5.5 -3.5	7.5 -5	V
	Clamping Voltage <sup>(3)</sup> (IEC61000-4-5 8/20 $\mu\text{s}$ , I/O Pin-to-Ground)	$I_{PP} = 10\text{A}$ $I_{PP} = -10\text{A}$		5.5 -2.5	7.5 -4	V
		$I_{PP} = 75\text{A}$ $I_{PP} = -75\text{A}$		13 -10	15 -12	V
$R_{DNY}$	Dynamic Resistance <sup>(3)</sup>	$I_{TLP} = 1\text{A to } 30\text{A}$ $I_{TLP} = -1\text{A to } -30\text{A}$		0.05 0.1		$\Omega$
$P_{PP}$	Peak Pulse Power	IEC61000-4-5, 8/20 $\mu\text{s}$ , I/O Pin-to-Ground			1100	W
$C_J$	Junction Capacitance	$V_{I/O} = 0\text{V}$ , $f = 1\text{MHz}$ , I/O Pin-to-Ground		100		pF

Symbol	Parameter	Condition	Min.	Typ.	Max.	Units
<b>AOZ8310DI-05</b>						
V <sub>RWM</sub>	Reverse Working Voltage	I/O Pin-to-Ground			5	V
V <sub>BR</sub>	Reverse Breakdown Voltage	I <sub>T</sub> = 1mA, I/O Pin-to-Ground	6	7.5	8.5	V
I <sub>R</sub>	Reverse Leakage Current	Max. V <sub>RWM</sub> , I/O Pin-to-Ground		100	1000	nA
I <sub>PP</sub>	Peak Pulse Current	IEC61000-4-5, 8/20μs, I/O Pin-to-Ground			85	A
V <sub>CL</sub>	Clamping Voltage <sup>(3)</sup> (100ns Transmission Line Pulse, I/O Pin-to-Ground)	I <sub>TLP</sub> = 1A I <sub>TLP</sub> = -1A		8 -1	9.5 -2	V
		I <sub>TLP</sub> = 30A I <sub>TLP</sub> = -30A		9.5 -3.5	11 -5	V
	Clamping Voltage <sup>(3)</sup> (IEC61000-4-5 8/20μs, I/O Pin-to- Ground)	I <sub>PP</sub> = 20A I <sub>PP</sub> = -20A		9.5 -2.5	11 -4	V
		I <sub>PP</sub> = 85A I <sub>PP</sub> = -85A		14.3 -6	16 -8	V
R <sub>DNY</sub>	Dynamic Resistance <sup>(3)</sup>	I <sub>TLP</sub> = 1A to 30A I <sub>TLP</sub> = -1A to -30A		0.05 0.09		Ω
P <sub>PP</sub>	Peak Pulse Power	IEC61000-4-5, 8/20μs, I/O Pin-to-Ground			1500	W
C <sub>J</sub>	Junction Capacitance	V <sub>I/O</sub> = 0V, f = 1MHz, I/O Pin-to-Ground		675		pF
<b>AOZ8310DI-08</b>						
V <sub>RWM</sub>	Reverse Working Voltage	I/O Pin-to-Ground			8	V
V <sub>BR</sub>	Reverse Breakdown Voltage	I <sub>T</sub> = 1mA, I/O Pin-to-Ground	9	10	12	V
I <sub>R</sub>	Reverse Leakage Current	Max. V <sub>RWM</sub> , I/O Pin-to-Ground		10	100	nA
I <sub>PP</sub>	Peak Pulse Current	IEC61000-4-5, 8/20μs, I/O Pin-to-Ground			70	A
V <sub>CL</sub>	Clamping Voltage <sup>(3)</sup> (100ns Transmission Line Pulse, I/O Pin-to-Ground)	I <sub>TLP</sub> = 1A I <sub>TLP</sub> = -1A		10.5 -0.9	12 -1.5	V
		I <sub>TLP</sub> = 30A I <sub>TLP</sub> = -30A		12 -3.7	13.5 -5	V
	Clamping Voltage <sup>(3)</sup> (IEC61000-4-5 8/20μs, I/O Pin-to- Ground)	I <sub>PP</sub> = 10A I <sub>PP</sub> = -10A		12 -2.4	14 -4	V
		I <sub>PP</sub> = 70A I <sub>PP</sub> = -70A		21 -9	24 -11	V
R <sub>DNY</sub>	Dynamic Resistance <sup>(3)</sup>	I <sub>TLP</sub> = 1A to 30A I <sub>TLP</sub> = -1A to -30A		0.05 0.1		Ω
P <sub>PP</sub>	Peak Pulse Power	IEC61000-4-5, 8/20μs, I/O Pin-to-Ground			1500	W
C <sub>J</sub>	Junction Capacitance	V <sub>I/O</sub> = 0V, f = 1MHz, I/O Pin-to-Ground		425		pF

Symbol	Parameter	Condition	Min.	Typ.	Max.	Units
<b>AOZ8310DI-09</b>						
V <sub>RWM</sub>	Reverse Working Voltage	I/O Pin-to-Ground			9	V
V <sub>BR</sub>	Reverse Breakdown Voltage	I <sub>T</sub> = 1mA, I/O Pin-to-Ground	10	11	13	V
I <sub>R</sub>	Reverse Leakage Current	Max. V <sub>RWM</sub> , I/O Pin-to-Ground		10	100	nA
I <sub>PP</sub>	Peak Pulse Current	IEC61000-4-5, 8/20μs, I/O Pin-to-Ground			65	A
V <sub>CL</sub>	Clamping Voltage <sup>(3)</sup> (100ns Transmission Line Pulse, I/O Pin-to-Ground)	I <sub>TLP</sub> = 1A I <sub>TLP</sub> = -1A		11.5 -0.9	13 -1.5	V
		I <sub>TLP</sub> = 30A I <sub>TLP</sub> = -30A		13.3 -3.7	15 -5	V
	Clamping Voltage <sup>(3)</sup> (IEC61000-4-5 8/20μs, I/O Pin-to-Ground)	I <sub>PP</sub> = 10A I <sub>PP</sub> = -10A		13.5 -2.4	15 -4.5	V
		I <sub>PP</sub> = 65A I <sub>PP</sub> = -65A		21.5 -8.5	24 -10.5	V
R <sub>DNY</sub>	Dynamic Resistance <sup>(3)</sup>	I <sub>TLP</sub> = 1A to 30A I <sub>TLP</sub> = -1A to -30A		0.05 0.1		Ω
P <sub>PP</sub>	Peak Pulse Power	IEC61000-4-5, 8/20μs, I/O Pin-to-Ground			1500	W
C <sub>J</sub>	Junction Capacitance	V <sub>I/O</sub> = 0V, f = 1MHz, I/O Pin-to-Ground		385		pF
<b>AOZ8310DI-12</b>						
V <sub>RWM</sub>	Reverse Working Voltage	I/O Pin-to-Ground			12	V
V <sub>BR</sub>	Reverse Breakdown Voltage	I <sub>T</sub> = 1mA, I/O Pin-to-Ground	13.2	15	17	V
I <sub>R</sub>	Reverse Leakage Current	Max. V <sub>RWM</sub> , I/O Pin-to-Ground		5	100	nA
I <sub>PP</sub>	Peak Pulse Current	IEC61000-4-5, 8/20μs, I/O Pin-to-Ground			45	A
V <sub>CL</sub>	Clamping Voltage <sup>(3)</sup> (100ns Transmission Line Pulse, I/O Pin-to-Ground)	I <sub>TLP</sub> = 1A I <sub>TLP</sub> = -1A		15.5 -0.9	18 -1.5	V
		I <sub>TLP</sub> = 30A I <sub>TLP</sub> = -30A		17 -3.5	19 -5	V
	Clamping Voltage <sup>(3)</sup> (IEC61000-4-5 8/20μs, I/O Pin-to-Ground)	I <sub>PP</sub> = 10A I <sub>PP</sub> = -10A		18 -2.4	21 -4.5	V
		I <sub>PP</sub> = 45A I <sub>PP</sub> = -45A		26 -6.8	30 -8.5	V
R <sub>DNY</sub>	Dynamic Resistance <sup>(3)</sup>	I <sub>TLP</sub> = 1A to 30A I <sub>TLP</sub> = -1A to -30A		0.05 0.1		Ω
P <sub>PP</sub>	Peak Pulse Power	IEC61000-4-5, 8/20μs, I/O Pin-to-Ground			1500	W
C <sub>J</sub>	Junction Capacitance	V <sub>I/O</sub> = 0V, f = 1MHz, I/O Pin-to-Ground		275		pF

Symbol	Parameter	Condition	Min.	Typ.	Max.	Units
<b>AOZ8310DI-18</b>						
V <sub>RWM</sub>	Reverse Working Voltage	I/O Pin-to-Ground			18	V
V <sub>BR</sub>	Reverse Breakdown Voltage	I <sub>T</sub> = 1mA, I/O Pin-to-Ground	19	21.5	24	V
I <sub>R</sub>	Reverse Leakage Current	Max. V <sub>RWM</sub> , I/O Pin-to-Ground		10	100	nA
I <sub>PP</sub>	Peak Pulse Current	IEC61000-4-5, 8/20μs, I/O Pin-to-Ground			35	A
V <sub>CL</sub>	Clamping Voltage <sup>(3)</sup> (100ns Transmission Line Pulse, I/O Pin-to-Ground)	I <sub>TLP</sub> = 1A I <sub>TLP</sub> = -1A		22 -1	24 -2	V
		I <sub>TLP</sub> = 30A I <sub>TLP</sub> = -30A		26 -4	29 -6	V
	Clamping Voltage <sup>(3)</sup> (IEC61000-4-5 8/20μs, I/O Pin-to-Ground)	I <sub>PP</sub> = 10A I <sub>PP</sub> = -10A		25 -2.5	29 -4.5	V
		I <sub>PP</sub> = 35A I <sub>PP</sub> = -35A		35 -6	39 -8	V
R <sub>DNY</sub>	Dynamic Resistance <sup>(3)</sup>	I <sub>TLP</sub> = 1A to 30A I <sub>TLP</sub> = -1A to -30A		0.1 0.1		Ω
P <sub>PP</sub>	Peak Pulse Power	IEC61000-4-5, 8/20μs, I/O Pin-to-Ground			1200	W
C <sub>J</sub>	Junction Capacitance	V <sub>I/O</sub> = 0V, f = 1MHz, I/O Pin-to-Ground		200		pF
<b>AOZ8310DI-20</b>						
V <sub>RWM</sub>	Reverse Working Voltage	I/O Pin-to-Ground			20	V
V <sub>BR</sub>	Reverse Breakdown Voltage	I <sub>T</sub> = 1mA, I/O Pin-to-Ground	22	25	28	V
I <sub>R</sub>	Reverse Leakage Current	Max. V <sub>RWM</sub> , I/O Pin-to-Ground		2	100	nA
I <sub>PP</sub>	Peak Pulse Current	IEC61000-4-5, 8/20μs, I/O Pin-to-Ground			32	A
V <sub>CL</sub>	Clamping Voltage <sup>(3)</sup> (100ns Transmission Line Pulse, I/O Pin-to-Ground)	I <sub>TLP</sub> = 1A I <sub>TLP</sub> = -1A		25.5 -0.9	28 -1.5	V
		I <sub>TLP</sub> = 30A I <sub>TLP</sub> = -30A		29 -3.5	32 -5	V
	Clamping Voltage <sup>(3)</sup> (IEC61000-4-5 8/20μs, I/O Pin-to-Ground)	I <sub>PP</sub> = 5A I <sub>PP</sub> = -5A		28 -2	31 -4	V
		I <sub>PP</sub> = 32A I <sub>PP</sub> = -32A		40 -5.5	44 -7.5	V
R <sub>DNY</sub>	Dynamic Resistance <sup>(3)</sup>	I <sub>TLP</sub> = 1A to 30A I <sub>TLP</sub> = -1A to -30A		0.12 0.1		Ω
P <sub>PP</sub>	Peak Pulse Power	IEC61000-4-5, 8/20μs, I/O Pin-to-Ground			1200	W
C <sub>J</sub>	Junction Capacitance	V <sub>I/O</sub> = 0V, f = 1MHz, I/O Pin-to-Ground		165		pF

Symbol	Parameter	Condition	Min.	Typ.	Max.	Units
<b>AOZ8310DI-26</b>						
V <sub>RWM</sub>	Reverse Working Voltage	I/O Pin-to-Ground			26	V
V <sub>BR</sub>	Reverse Breakdown Voltage	I <sub>T</sub> = 1mA, I/O Pin-to-Ground	28	31	35	V
I <sub>R</sub>	Reverse Leakage Current	Max. V <sub>RWM</sub> , I/O Pin-to-Ground		1	100	nA
I <sub>PP</sub>	Peak Pulse Current	IEC61000-4-5, 8/20μs, I/O Pin-to-Ground			25	A
V <sub>CL</sub>	Clamping Voltage <sup>(3)</sup> (100ns Transmission Line Pulse, I/O Pin-to-Ground)	I <sub>TLP</sub> = 1A I <sub>TLP</sub> = -1A		32 -0.9	35 -1.5	V
		I <sub>TLP</sub> = 30A I <sub>TLP</sub> = -30A		45 -4.5	50 -5	V
	Clamping Voltage <sup>(3)</sup> (IEC61000-4-5 8/20μs, I/O Pin-to-Ground)	I <sub>PP</sub> = 5A I <sub>PP</sub> = -5A		36 -2	40 -4	V
		I <sub>PP</sub> = 25A I <sub>PP</sub> = -25A		50 -5.5	55 -7.5	V
R <sub>DNY</sub>	Dynamic Resistance <sup>(3)</sup>	I <sub>TLP</sub> = 1A to 25A I <sub>TLP</sub> = -1A to -25A		0.45 -0.12		Ω
P <sub>PP</sub>	Peak Pulse Power	IEC61000-4-5, 8/20μs, I/O Pin-to-Ground			1200	W
C <sub>J</sub>	Junction Capacitance	V <sub>I/O</sub> = 0V, f = 1MHz, I/O Pin-to-Ground		150		pF
<b>AOZ8310DI-36</b>						
V <sub>RWM</sub>	Reverse Working Voltage	I/O Pin-to-Ground			36	V
V <sub>BR</sub>	Reverse Breakdown Voltage	I <sub>T</sub> = 1mA, I/O Pin-to-Ground	37	39	44	V
I <sub>R</sub>	Reverse Leakage Current	Max. V <sub>RWM</sub> , I/O Pin-to-Ground		10	100	nA
I <sub>PP</sub>	Peak Pulse Current	IEC61000-4-5, 8/20μs, I/O Pin-to-Ground			22	A
V <sub>CL</sub>	Clamping Voltage <sup>(3)</sup> (100ns Transmission Line Pulse, I/O Pin-to-Ground)	I <sub>TLP</sub> = 1A I <sub>TLP</sub> = -1A		43 -1	47 -2	V
		I <sub>TLP</sub> = 30A I <sub>TLP</sub> = -30A		52 -3.5	56 -5	V
	Clamping Voltage <sup>(3)</sup> (IEC61000-4-5 8/20μs, I/O Pin-to-Ground)	I <sub>PP</sub> = 2A I <sub>PP</sub> = -2A		45 -1.3	48 -2	V
		I <sub>PP</sub> = 22A I <sub>PP</sub> = -22A		72 -4.3	77 -7	V
R <sub>DNY</sub>	Dynamic Resistance <sup>(3)</sup>	I <sub>TLP</sub> = 1A to 30A I <sub>TLP</sub> = -1A to -30A		0.28 0.1		Ω
P <sub>PP</sub>	Peak Pulse Power	IEC61000-4-5, 8/20μs, I/O Pin-to-Ground			1500	W
C <sub>J</sub>	Junction Capacitance	V <sub>I/O</sub> = 0V, f = 1MHz, I/O Pin-to-Ground		130		pF

**Note:**

3. These specifications are guaranteed by design and characterization.

## Typical Characteristics

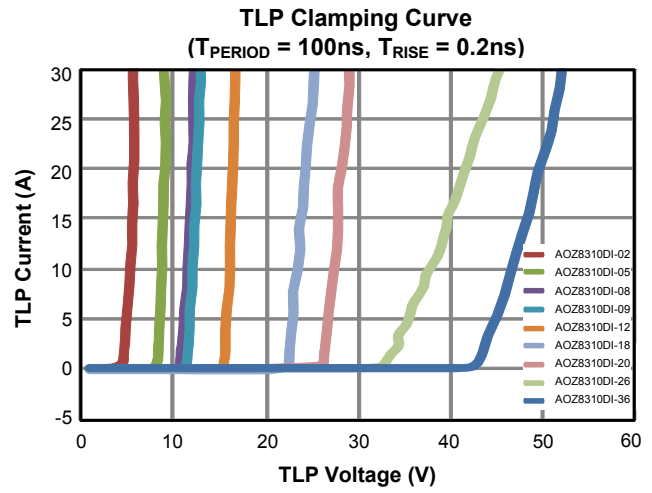
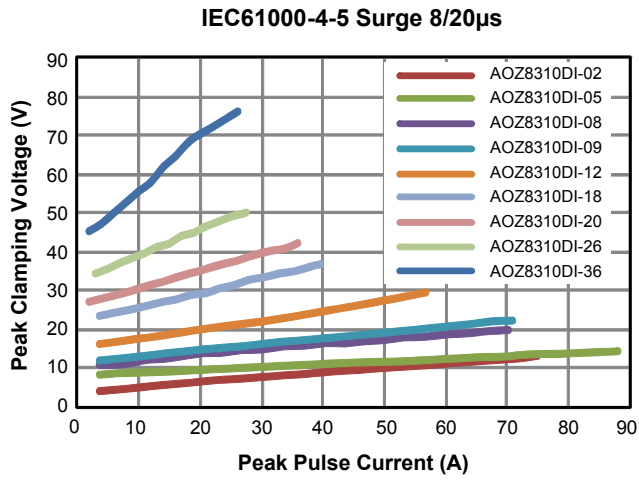



Package Dimensions, DFN1.6x1.0-2L, EPS\_S

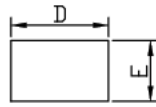

TOP VIEW



SIDE VIEW

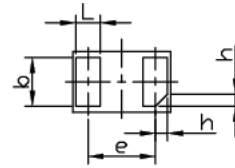

BOTTOM VIEW

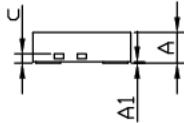

SIDE VIEW

RECOMMENDED LAND PATTERN

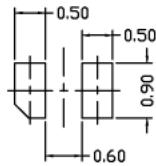

SYMBOLS	DIMENSIONS IN MILLIMETERS			DIMENSIONS IN INCHES		
	MIN	NOM	MAX	MIN	NOM	MAX
A	0.45	0.50	0.55	0.018	0.020	0.022
A1	---	0.02	0.05	----	0.001	0.002
b	0.75	0.80	0.85	0.030	0.031	0.033
c	0.10	0.15	0.20	0.004	0.006	0.008
D	1.55	1.60	1.65	0.061	0.063	0.065
e	1.10 BSC			0.043 BSC		
E	0.95	1.00	1.05	0.037	0.039	0.041
L	0.35	0.40	0.45	0.014	0.016	0.018
h	0.15	0.20	0.25	0.006	0.008	0.010

UNIT: mm

NOTE

1. CONTROLLING DIMENSION IS MILLIMETER.  
CONVERTED INCH DIMENSIONS ARE NOT NECESSARILY EXACT.
2. TOLERANCE :±0.05 UNLESS OTHERWISE SPECIFIED.
3. RADIUS ON ALL CORNER ARE 0.152 MAX., UNLESS OTHERWISE SPECIFIED.
4. PACKAGE WARPAGE: 0.012 MAX.
5. NO ANY PLASTIC FLASH ALLOWED ON THE TOP AND BOTTOM LEAD SURFACE.
6. PAD PLANARITY: ±0.102
7. CRACK BETWEEN PLASTIC BODY AND LEAD IS NOT ALLOWED.

Tape and Reel Dimensions, DFN1.6x1.0-2L, EPS\_S

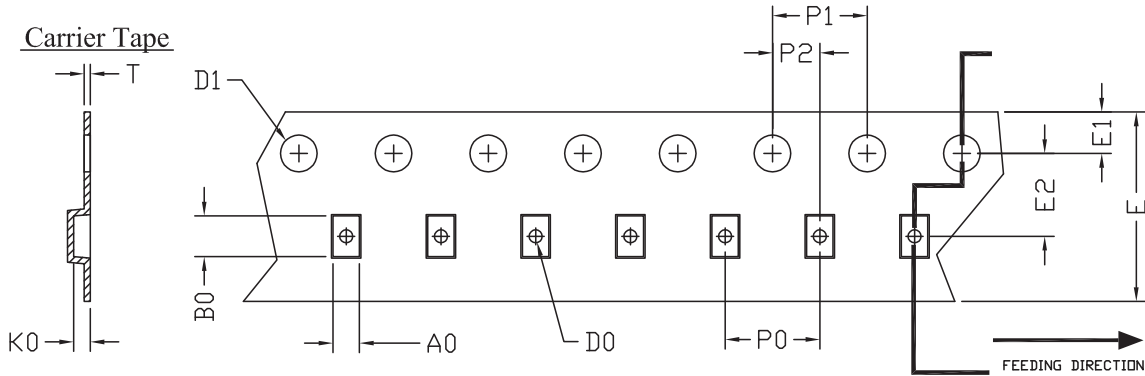

UNIT: MM

PACKAGE	A0	B0	K0	D0	D1	E	E1	E2	P0	P1	P2	T
DFN1.6x1.0	1.07	1.67	0.65	0.40	1.45	7.80	1.75	3.50	4.00	4.00	2.00	0.18
DFN1.6x0.8	~1.35	~1.90	~0.90	~0.60	~1.65	~8.30	±0.10	±0.05	±0.10	±0.10	±0.05	~0.30
DFN1.45x1.0												

Reel

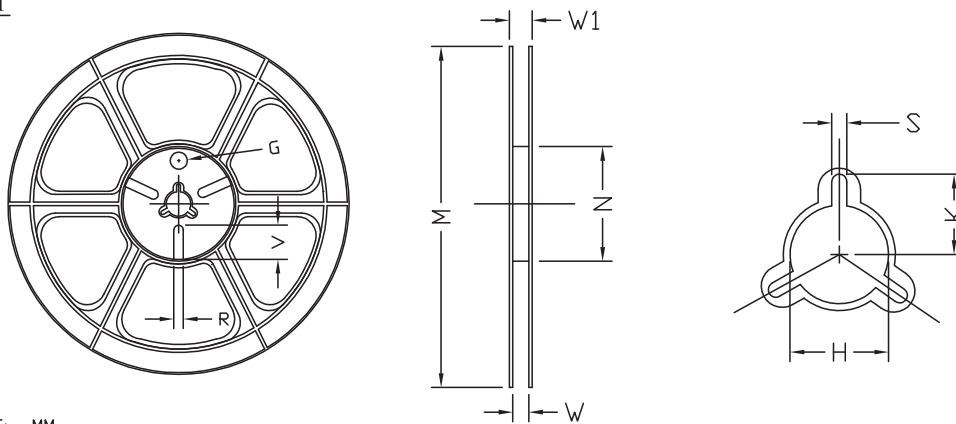

UNIT: MM

TAPE SIZE	REEL SIZE	M	N	W	W1	H	K	S	G	R	V
8 mm	ø178	ø178 ±1.0	ø52.0 ±1.0	9.0 ±0.5	N/A	ø13.0 <sup>+0.5</sup> -0.2	10.25 ±0.2	2.40 ±0.10	ø9.8	N/A	N/A

Tape

Leader / Trailer  
& Orientation

Unit Per Reel:  
3000pcs

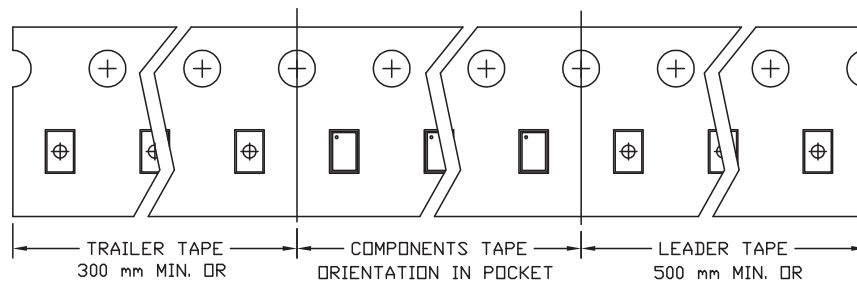

## Part Marking

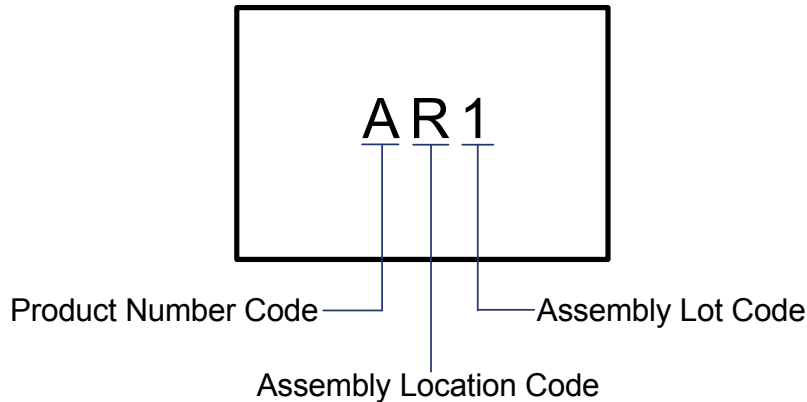

Part Number	Part Number Code of Marking
AOZ8310DI-02	N
AOZ8310DI-05	L
AOZ8310DI-08	E
AOZ8310DI-09	F
AOZ8310DI-12	G
AOZ8310DI-18	H
AOZ8310DI-20	D
AOZ8310DI-26	S
AOZ8310DI-36	K

### LEGAL DISCLAIMER

Alpha and Omega Semiconductor makes no representations or warranties with respect to the accuracy or completeness of the information provided herein and takes no liabilities for the consequences of use of such information or any product described herein. Alpha and Omega Semiconductor reserves the right to make changes to such information at any time without further notice. This document does not constitute the grant of any intellectual property rights or representation of non-infringement of any third party's intellectual property rights.

### LIFE SUPPORT POLICY

ALPHA AND OMEGA SEMICONDUCTOR PRODUCTS ARE NOT AUTHORIZED FOR USE AS CRITICAL COMPONENTS IN LIFE SUPPORT DEVICES OR SYSTEMS.

As used herein:

1. Life support devices or systems are devices or systems which, (a) are intended for surgical implant into the body or (b) support or sustain life, and (c) whose failure to perform when properly used in accordance with instructions for use provided in the labeling, can be reasonably expected to result in a significant injury of the user.
2. A critical component in any component of a life support, device, or system whose failure to perform can be reasonably expected to cause the failure of the life support device or system, or to affect its safety or effectiveness.

单击下面可查看定价，库存，交付和生命周期等信息

[>>AOS\(万国半导体\)](#)