

## General Description

The AOZ8831-24 is an ultra low capacitance one-line bi-directional transient voltage suppressor diode designed to protect high speed data lines and voltage sensitive electronics from high transient conditions and ESD.

This device incorporates one TVS diode in an ultra-small DFN 1.0 x 0.6 package. It may be used to meet the ESD immunity requirements of IEC 61000-4-2, Level 4 ( $\pm 15\text{kV}$  air,  $\pm 13\text{kV}$  contact discharge).

The AOZ8831-24 comes in an RoHS compliant DFN package and is rated over a  $-40^{\circ}\text{C}$  to  $+125^{\circ}\text{C}$  ambient temperature range.

The ultra-small 1.0 x 0.6 x 0.4mm DFN package makes it ideal for applications where PCB space is a premium. The small size and high ESD protection makes it ideal for protecting voltage sensitive electronics from high transient conditions and ESD.

## Features

- ESD protection for high-speed data lines:
  - Exceeds: IEC 61000-4-2 (ESD)  $\pm 15\text{kV}$  (air),  $\pm 13\text{kV}$  (contact)
  - Human Body Model (HBM)  $\pm 15\text{kV}$
- Small package saves board space
- Ultra low capacitance: 0.35pF
- Low clamping voltage
- Operating voltage: 24V
- Pb-free device

## Applications

- Portable handheld devices
- Notebook computers
- Digital Cameras
- Portable GPS



## Typical Application

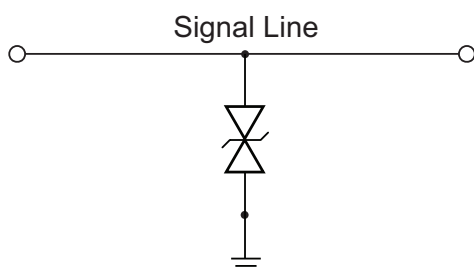

**Bidirection Protection of Single Line**

## Pin Configuration

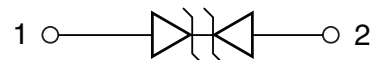

## Ordering Information

Part Number	Ambient Temperature Range	Package	Environmental
AOZ8831DT-24	-40°C to +125°C	DFN 1.0 x 0.6	Green Product



AOS Green Products use reduced levels of Halogens, and are also RoHS compliant. Please visit [www.aosmd.com/media/AOSGreenPolicy.pdf](http://www.aosmd.com/media/AOSGreenPolicy.pdf) for additional information.

## Absolute Maximum Ratings

*Exceeding the Absolute Maximum ratings may damage the device.*

Parameter	Rating
VP – VN	24V
Peak Pulse Current ( $I_{PP}$ ), $t_P = 8/20\mu s$	1.2A
Peak Pulse Power, $t_P = 8/20\mu s$	60W
Storage Temperature ( $T_S$ )	-65°C to +150°C
ESD Rating per IEC61000-4-2, Contact <sup>(1)</sup>	±13kV
ESD Rating per IEC61000-4-2, Air <sup>(1)</sup>	±15kV
ESD Rating per Human Body Model <sup>(2)</sup>	±15kV

### Notes:

- IEC 61000-4-2 discharge with  $C_{Discharge} = 150pF$ ,  $R_{Discharge} = 330\Omega$ .
- Human Body Discharge per MIL-STD-883, Method 3015  $C_{Discharge} = 100pF$ ,  $R_{Discharge} = 1.5k\Omega$ .

## Maximum Operating Ratings

Parameter	Rating
Junction Temperature ( $T_J$ )	-40°C to +125°C

### Electrical Characteristics

T<sub>A</sub> = 25°C unless otherwise specified.

Symbol	Parameter	Diagram
I <sub>PP</sub>	Maximum Reverse Peak Pulse Current <sup>(3)</sup> (100ns Transmission Line Pulse (TLP))	
V <sub>CL</sub>	Clamping Voltage @ I <sub>PP</sub> <sup>(3)</sup>	
V <sub>P</sub>	Peak Voltage (IEC61000-4-5 8/20μs, Surge Current I <sub>PEAK</sub> = 1A)	
V <sub>RWM</sub>	Working Peak Reverse Voltage	
I <sub>R</sub>	Maximum Reverse Leakage Current	
V <sub>BR</sub>	Breakdown Voltage	
C <sub>J</sub>	Capacitance @ V <sub>R</sub> = 0 and f = 1MHz	

Device	Device Marking	V <sub>RWM</sub> (V) Max.	V <sub>BR</sub> (V) Min.	I <sub>R</sub> (μA) Max.	V <sub>CL</sub> Max.			V <sub>P</sub> (V) Max.	C <sub>J</sub> (pF)		
					I <sub>PP</sub> = 1A	I <sub>PP</sub> = 2A	I <sub>PP</sub> = 5A		Min.	Typ.	Max.
AOZ8831DT-24	2	24	26	0.1	38	40	48	45	0.2	0.35	0.5

**Notes:**

3. These specifications are guaranteed by design and characterization.

## Typical Performance Characteristics

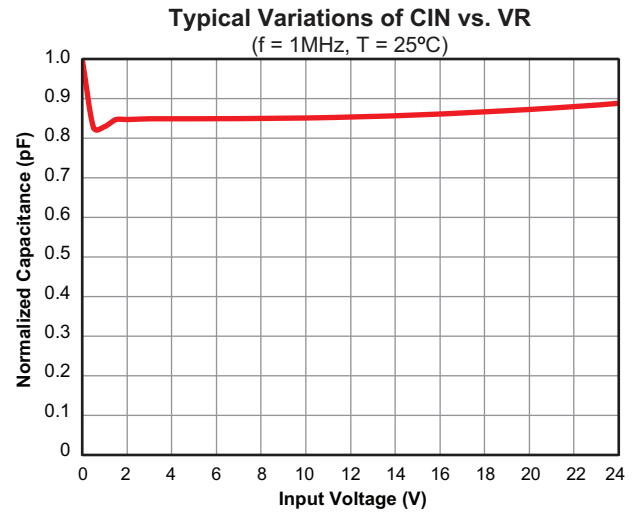
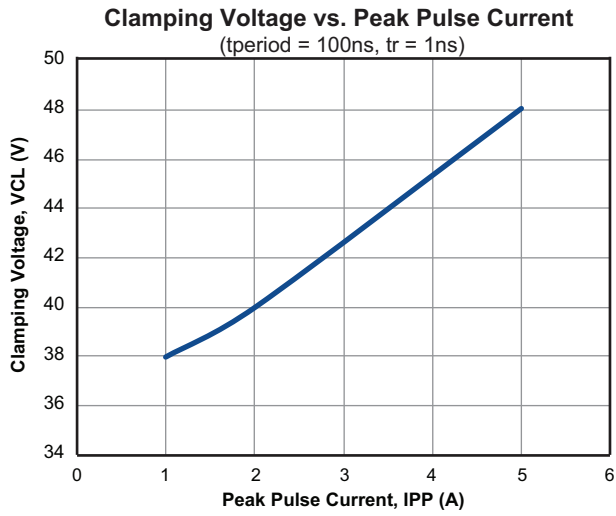

Package Dimensions, DFN 1.0 x 0.6

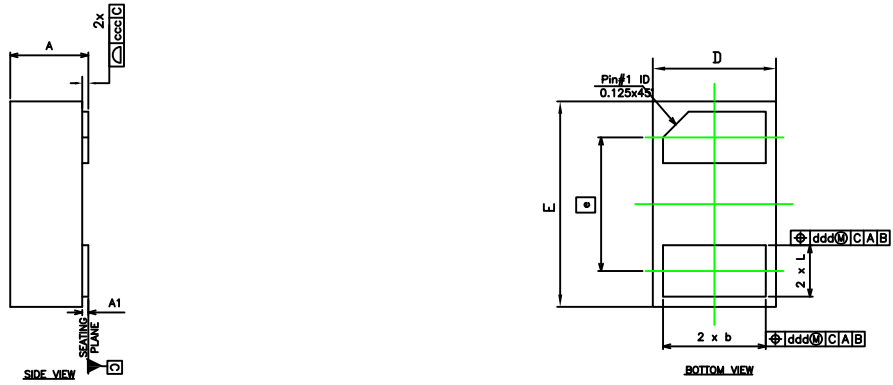

RECOMMENDED LAND PATTERN

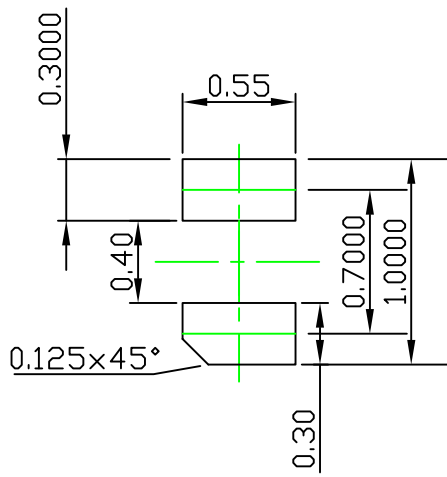

UNIT: mm

SYMBOLS	DIMENSIONS IN MILLIMETERS			DIMENSIONS IN INCHES		
	MIN	NOM	MAX	MIN	NOM	MAX
A	0.31	0.38	0.40	0.012	0.015	0.016
A1	0.00	0.02	0.05	0.000	0.001	0.002
b	0.45	0.50	0.55	0.018	0.020	0.022
D	0.55	0.60	0.65	0.022	0.024	0.026
E	0.95	1.00	1.05	0.037	0.039	0.041
e	0.65 BSC			0.026 BSC		
L	0.20	0.25	0.30	0.008	0.010	0.012
ccc	0.03			0.001		
ddd	0.10			0.004		

### Tape and Reel Dimensions, DFN 1.0 x 0.6

#### Carrier Tape

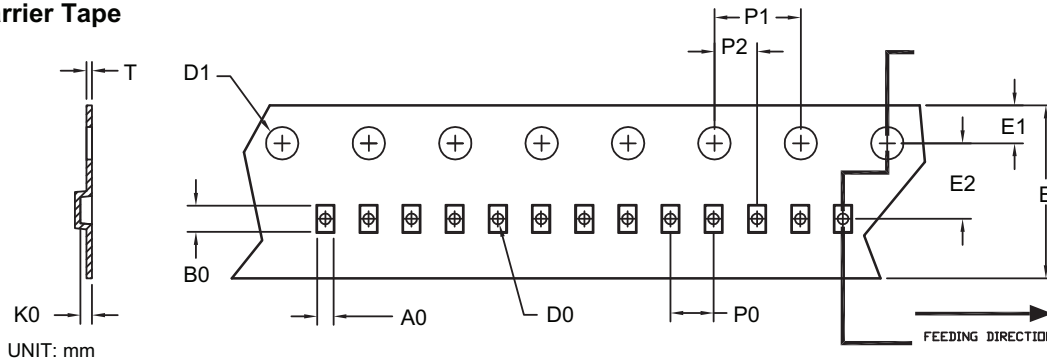

UNIT: mm

Option	Package	A0	B0	K0	D0	D1	E	E1	E2	P0	P1	P2	T
A	DFN 1.0x0.6/ DFN 1.0x0.6A (8 mm)	0.69 ±0.05	1.19 ±0.05	0.66 ±0.05	0.40 ±0.05	1.50 ±0.10	8.00 +0.3/-0.1	1.75 ±0.10	3.50 ±0.05	2.00 ±0.05	4.00 ±0.10	0.20 ±0.05	0.23 ±0.02
B	DFN 1.0x0.6/ DFN 1.0x0.6A (8 mm)	0.65 ±0.04	1.05 ±0.04	0.61 ±0.04	0.40 ±0.05	1.50 ±0.10	8.00 +0.3/-0.1	1.75 ±0.10	3.50 ±0.05	2.00 ±0.10	4.00 ±0.10	0.20 ±0.05	0.20 ±0.05

#### Reel

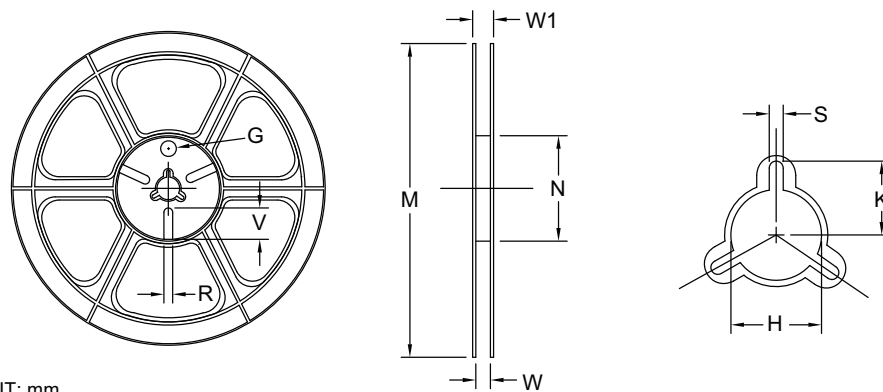

UNIT: mm

Tape Size	Reel Size	M	N	W	W1	H	K	S	G	R	V
8mm	ø178	ø178 ±0.5	ø55 ±1	8.4 +1.5/-0	Max. 14.4	ø13.0 ±0.5	Max. 10.1	2.0 ±0.5	N/A	N/A	N/A

#### Leader / Trailer & Orientation

TVS  
Unit Per Reel:  
10000pcs

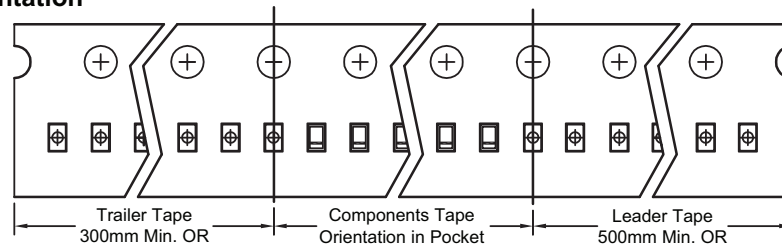

MOS  
Unit Per Reel:  
10000pcs

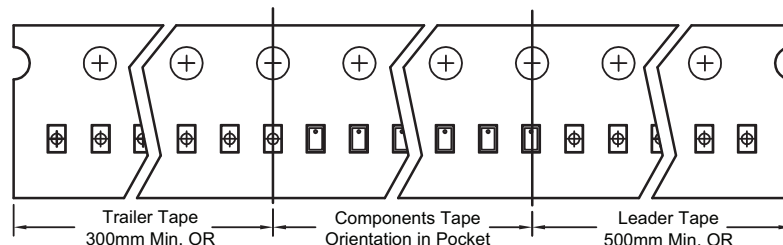

## Part Marking

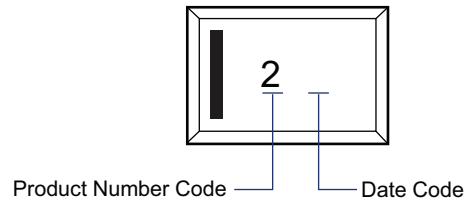

### LEGAL DISCLAIMER

Alpha and Omega Semiconductor makes no representations or warranties with respect to the accuracy or completeness of the information provided herein and takes no liabilities for the consequences of use of such information or any product described herein. Alpha and Omega Semiconductor reserves the right to make changes to such information at any time without further notice. This document does not constitute the grant of any intellectual property rights or representation of non-infringement of any third party's intellectual property rights.

### LIFE SUPPORT POLICY

ALPHA AND OMEGA SEMICONDUCTOR PRODUCTS ARE NOT AUTHORIZED FOR USE AS CRITICAL COMPONENTS IN LIFE SUPPORT DEVICES OR SYSTEMS.

As used herein:

1. Life support devices or systems are devices or systems which, (a) are intended for surgical implant into the body or (b) support or sustain life, and (c) whose failure to perform when properly used in accordance with instructions for use provided in the labeling, can be reasonably expected to result in a significant injury of the user.

2. A critical component in any component of a life support, device, or system whose failure to perform can be reasonably expected to cause the failure of the life support device or system, or to affect its safety or effectiveness.

单击下面可查看定价，库存，交付和生命周期等信息

[>>AOS\(万国半导体\)](#)