

## General Description

The AOZ8S315BLS is a single channel transient voltage suppressor designed to protect high speed data lines and voltage sensitive electronics from high transient conditions and ESD.

The AOZ8S315BLS comes in an RoHS compliant package and is rated over a -40°C to +125°C ambient temperature range.

The ultra-small 0.6 mm x 0.3 mm 0201 footprint package makes the AOZ8S315BLS ideal for applications where PCB space is a premium. The small size and high ESD protection makes it ideal for protecting voltage sensitive electronics from high transient conditions and ESD.

## Features

- ESD protection for high-speed data lines:
  - IEC 61000 4-2, ESD immunity:
  - Air discharge:  $\pm 24$  kV
  - Contact Discharge:  $\pm 22$  kV
  - IEC 61000-4-5 (Lightning 8/20  $\mu$ s): 9 A
  - IEC 61000-4-4 EFT (5/50 ns): 80 A
  - Human Body Mode:  $\pm 8$  kV
- Bidirectional TVS
- Low capacitance: 0.2 pF
- Low clamping voltage
- Low operating voltage: 3.3 V, 5 V

## Applications

- USB4, Thunderbolt 4, PCI Express
- Mobile phones
- Notebook computers



## Typical Applications

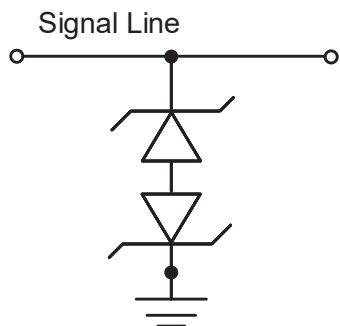

## Pin Configuration

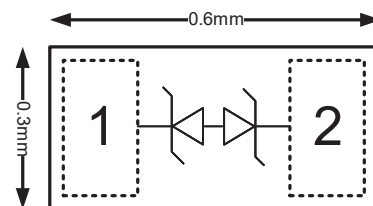

## Ordering Information

Part Number	Ambient Temperature Range	Package	Environmental
AOZ8S315BLS-03	-40°C to +125°C	WLCSP 0.6x0.3-2	Green Product
AOZ8S315BLS-05	-40°C to +125°C	WLCSP 0.6x0.3-2	Green Product



AOS products are offered in packages with Pb-free plating and compliant to RoHS standards. Please visit [www.aosmd.com/media/AOSGreenPolicy.pdf](http://www.aosmd.com/media/AOSGreenPolicy.pdf) for additional information.

## Absolute Maximum Ratings

(T<sub>A</sub> = 25°C, unless otherwise noted) Exceeding the Absolute Maximum Ratings may damage the device.

Parameter	Rating
AOZ8S315BLS-03 Any Pin to Pin AOZ8S315BLS-05 Any Pin to Pin	3.3 V 5 V
Peak Pulse Current (I <sub>PP</sub> ), t <sub>P</sub> = 8/20 μs	9 A
Peak Pulse Power (P <sub>PP</sub> ), t <sub>P</sub> = 8/20 μs	70 W
Storage Temperature (T <sub>S</sub> )	-65°C to +150°C
ESD Rating per IEC61000-4-2, Contact <sup>(1)</sup>	±22 kV
ESD Rating per IEC61000-4-2, Air <sup>(1)</sup>	±24 kV
ESD Rating per Human Body Mode <sup>(2)</sup>	±8 kV

### Notes:

- IEC 61000-4-2 discharge with C<sub>Discharge</sub> = 150 pF, R<sub>Discharge</sub> = 330 Ω.
- Human Body Discharge per MIL-STD-883, Method 3015 C<sub>Discharge</sub> = 100 pF, R<sub>Discharge</sub> = 1.5 kΩ

## Maximum Operating Ratings

The device is not guaranteed to operate beyond the Maximum Operating Conditions.

Parameter	Rating
Junction Temperature (T <sub>J</sub> )	-40 °C to +125 °C

## Electrical Characteristics

T<sub>A</sub> = 25°C, unless otherwise noted. Any I/O Pin-to-Ground.

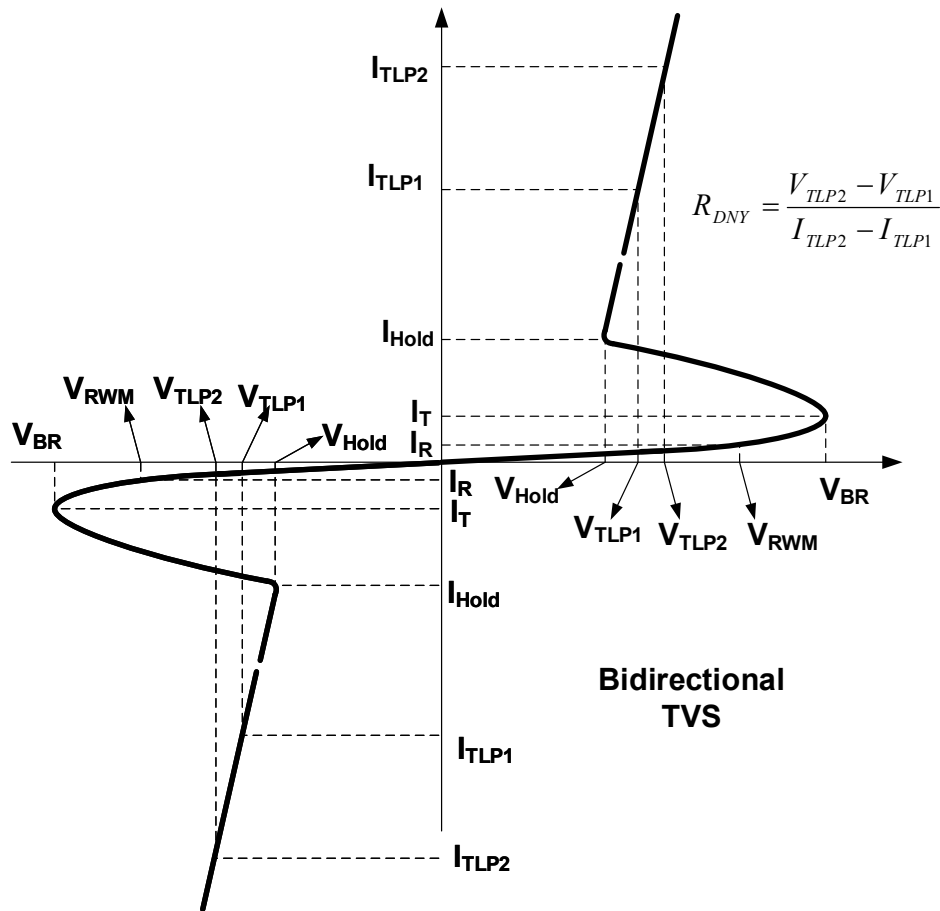

Symbol	Parameter	Conditions	Min	Typ	Max	Units
V <sub>RWM</sub>	Reverse Working Voltage	AOZ8S315BLS-03 AOZ8S315BLS-05			3.3 5	V
V <sub>BR</sub>	Reverse Breakdown Voltage	I <sub>T</sub> = 100 μA	6	7.5	9	V
I <sub>R</sub>	Reverse Leakage Current	Max. V <sub>RWM</sub>		1	50	nA
V <sub>CL</sub>	Clamping Voltage <sup>(3)(4)</sup> (100 ns Transmission Line Pulse)	I <sub>TLP</sub> = 1 A		2.5		V
		I <sub>TLP</sub> = 16 A		5.5		
V <sub>CL</sub>	Clamping Voltage <sup>(3)</sup> (IEC61000-4-5, 8/20 μs)	I <sub>PP</sub> = 1 A		2.5		V
		I <sub>PP</sub> = 9 A		6		
R <sub>DNY</sub>	Dynamic Resistance <sup>(3)(4)</sup>	I <sub>TLP</sub> = 1A to 16 A		0.25		Ω
C <sub>J</sub>	Junction Capacitance	V <sub>I/O</sub> = 0V, f = 1Mhz		0.20	0.25	pF

**Notes:**

- 3. These specifications are guaranteed by design and characterization.
- 4. Measurements performed using a 100ns Transmission Line Pulse (TLP) system.

## Typical Performance Characteristics

Positive Transmission Line Pulse  
( $t_p=100\text{ns}$ ,  $t_r=0.2\text{ns}$ )

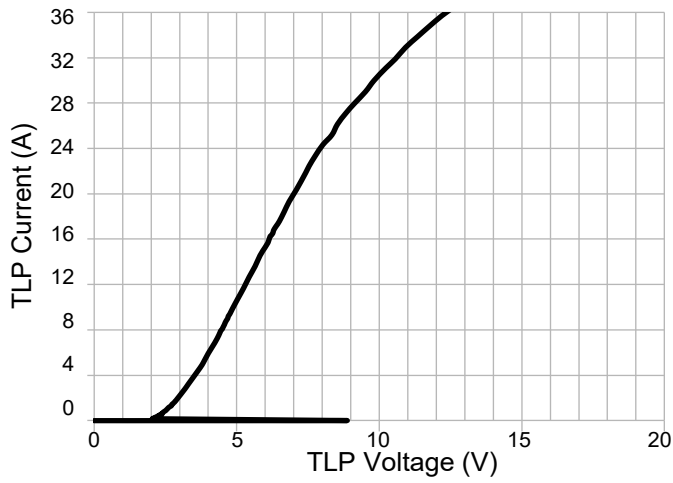

Negative Transmission Line Pulse  
( $t_p=100\text{ns}$ ,  $t_r=0.2\text{ns}$ )

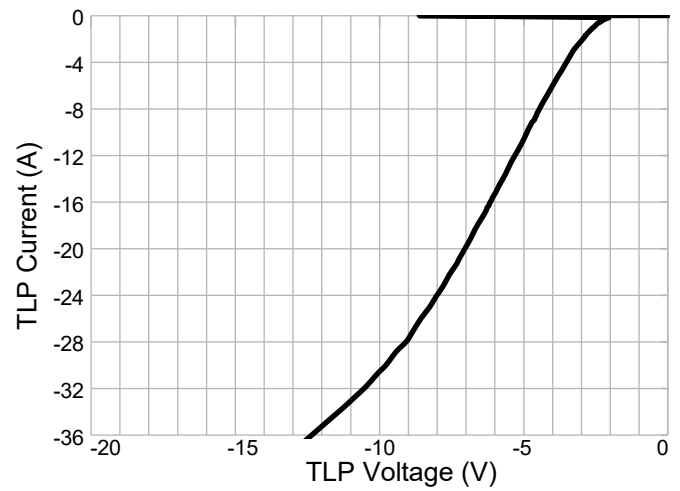

Typical Variations of CJ vs. Input Voltage

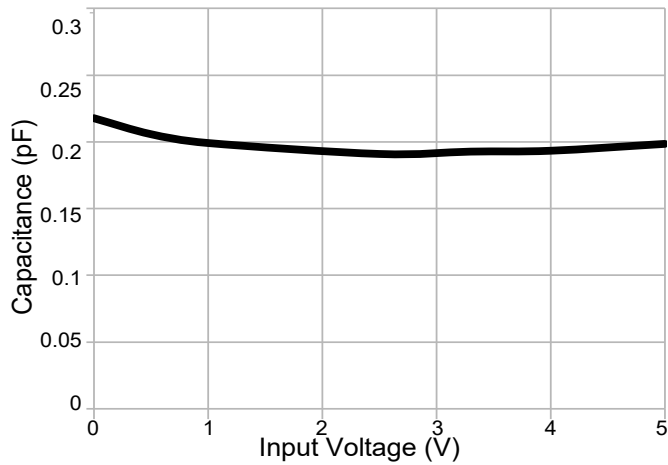

IEC61000-4-5 Surge 8/20 $\mu\text{s}$  (Any pin to pin)

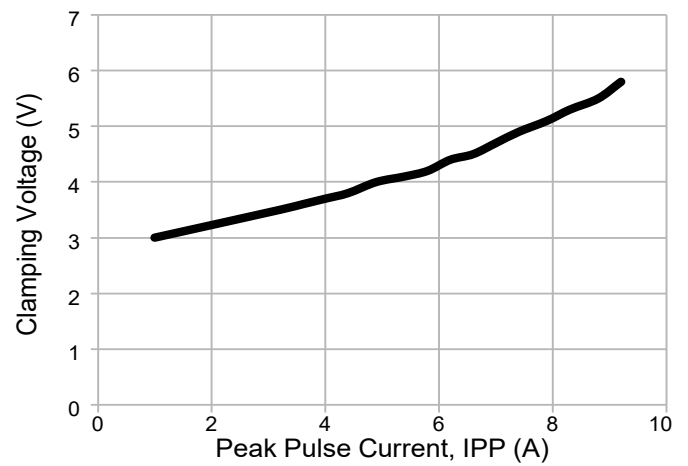

## Typical Performance Characteristics (Continued)

USB3.2 Gen2 Eye Diagram (10 Gbps)

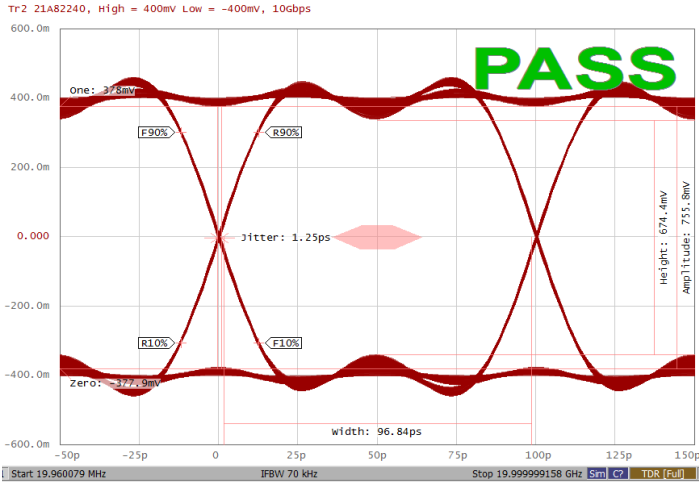

HDMI2.1 Eye Diagram (12 Gbps)

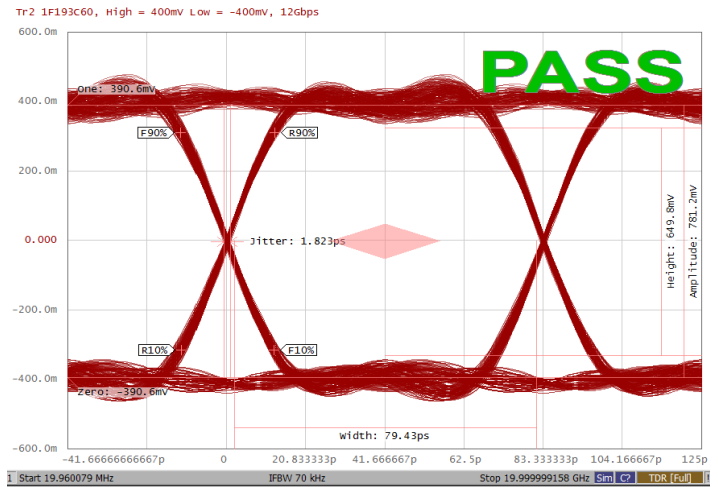

Thunderbolt 3.0 Eye Diagram (20 Gbps)

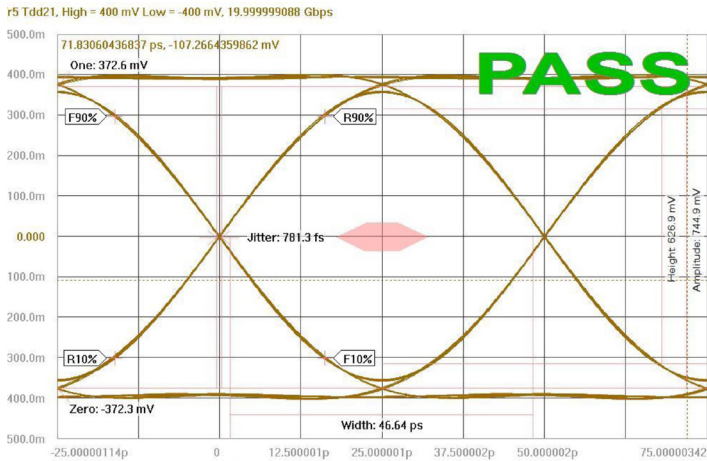

AOZ8S315BLS Inserion Loss

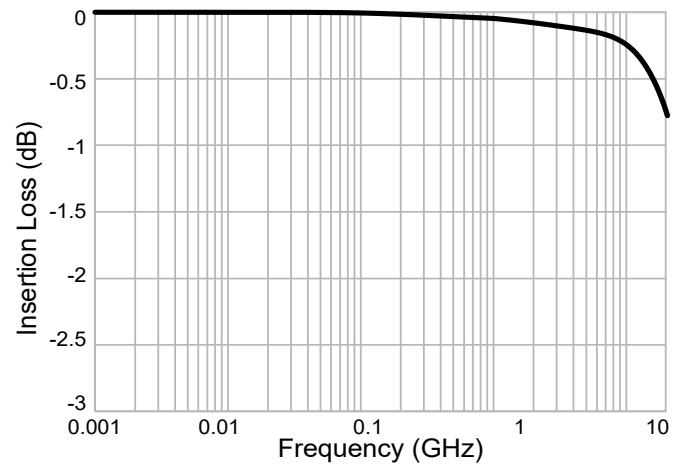

## LEGAL DISCLAIMER

Applications or uses as critical components in life support devices or systems are not authorized. AOS does not assume any liability arising out of such applications or uses of its products. AOS reserves the right to make changes to product specifications without notice. It is the responsibility of the customer to evaluate suitability of the product for their intended application. Customer shall comply with applicable legal requirements, including all applicable export control rules, regulations and limitations.

AOS' products are provided subject to AOS' terms and conditions of sale which are set forth at:  
[http://www.aosmd.com/terms\\_and\\_conditions\\_of\\_sale](http://www.aosmd.com/terms_and_conditions_of_sale)

## LIFE SUPPORT POLICY

ALPHA AND OMEGA SEMICONDUCTOR PRODUCTS ARE NOT AUTHORIZED FOR USE AS CRITICAL COMPONENTS IN LIFE SUPPORT DEVICES OR SYSTEMS.

As used herein:

1. Life support devices or systems are devices or systems which, (a) are intended for surgical implant into the body or (b) support or sustain life, and (c) whose failure to perform when properly used in accordance with instructions for use provided in the labeling, can be reasonably expected to result in a significant injury of the user.
2. A critical component in any component of a life support, device, or system whose failure to perform can be reasonably expected to cause the failure of the life support device or system, or to affect its safety or effectiveness.

单击下面可查看定价，库存，交付和生命周期等信息

[>>AOS\(万代\)](#)