

General Description

The AOZ8S507BDS-07 is a 1-channel bidirectional high surge transient voltage suppressor designed to protect data lines such as audio line and power rail from damaging ESD or surge events.

This device incorporates two unidirectional TVS diodes in a single package. During transient conditions, the bidirectional diodes direct the transient to either the positive side of the power supply line or to ground.

The AOZ8S507BDS-07 provides a typical capacitance of 19 pF and low clamping voltage making it ideally suited for data transmission protection in mobile and computing devices.

The AOZ8S507BDS-07 comes in a RoHS compliant and Halogen Free 1.0mm × 0.6mm × 0.5mm package and is rated for -40°C to +125°C junction temperature range.

Features

- IEC 61000-4-2, ESD immunity:
 - Air discharge: ±30kV
 - Contact discharge: ±30kV
- IEC 61000-4-5, surge immunity (8/20 μs): 9A
- IEC 61000-4-4 (EFT, 5/50ns): 40A
- Human body mode (HBM): ±8kV
- Junction capacitance: 19 pF
- Low clamping voltage
- Reverse working voltage: 7 V

Applications

- Audio & power lines
- General purpose
- Mobile phone
- Notebook computers



Typical Application

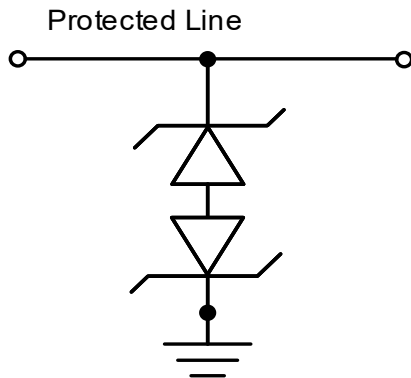

Pin Configuration

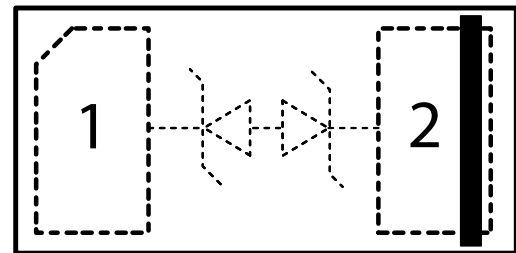

DFN1.0x0.6_2L
(Top View)

Ordering Information

Part Number	Ambient Temperature Range	Package	Environmental
AOZ8S507BDS-07	-40°C to +125°C	DFN1.0x0.6-2L	Green Product



AOS Green Products use reduced levels of Halogens, and are also RoHS compliant. Please visit www.aosmd.com/media/AOSGreenPolicy.pdf for additional information.

Absolute Maximum Ratings

Exceeding the Absolute Maximum ratings may damage the device.

Parameter	Rating
Storage Temperature (T _s)	-65°C to +150°C
ESD Rating per IEC61000-4-2, Contact and Air ⁽¹⁾	±30kV
8/20ms Surge IEC61000-4-5 Peak Pulse Current	± 9 A
EFT Rating per IEC61000-4-4 (5/50ns)	40A
ESD Rating per Human Body Model ⁽²⁾	±8kV

Notes:

- IEC 61000-4-2 discharge with C_{Discharge} = 150pF, R_{Discharge} = 330Ω
- Human Body Discharge per MIL-STD-883, Method 3015 C_{Discharge} = 100 pF, R_{Discharge} = 1.5kΩ

Maximum Operating Ratings

Parameter	Rating
Junction Temperature (T _j)	-40°C to + 125°C

Electrical Characteristics

TA = 25°C unless otherwise specified. Any I/O pin to pin.

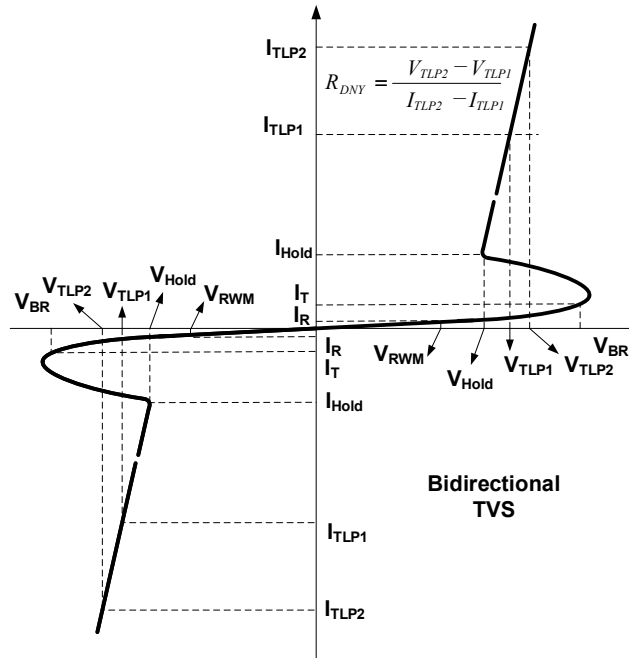

Symbol	Parameter	Conditions	Min	Typ	Max	Units
V_{RWM}	Reverse Working Voltage				7	V
V_{BR}	Reverse Breakdown Voltage	$I_T = 1\text{mA}$	7.8	9	11	V
I_R	Reverse Leakage Current	$V_T = \text{Max. } V_{RWM}$		1	100	nA
V_{HOLD}	Hold Voltage of Snapback ⁽³⁾	$I_T = 100\text{mA}$	7			V
V_{CL}	Clamping Voltage ^{(3) (4)} (100ns Transmission Line Pulse)	$I_{TLP} = 1\text{A}$ $I_{TLP} = 16\text{A}$ $I_{TLP} = 30\text{A}$		7.5 9.5 11		
V_{CL}	Clamping Voltage ⁽³⁾ (IEC61000-4-5 Surge 8/20µs)	$I_{PP} = 2\text{A}$ $I_{PP} = 9\text{A}$		8.5 10.5		
C_J	Junction Capacitance ⁽³⁾	$V_{I/O} = 0\text{V}, f = 1\text{MHz}$		19		pF

Notes:

- 3. These specifications are guaranteed by design and characterization.
- 4. Measurements performed using a 100ns Transmission Line Pulse (TLP) system.

Typical Characteristics

Positive Transmission Line Pulse
($t_p=100\text{ns}$, $t_r=0.2\text{ns}$)

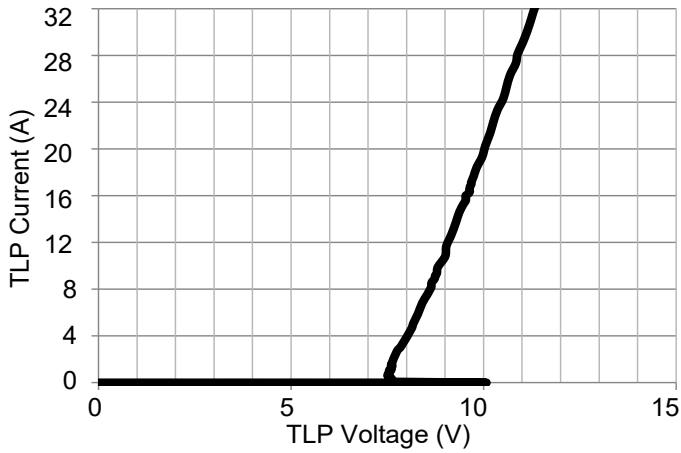

Negative Transmission Line Pulse
($t_p=100\text{ns}$, $t_r=0.2\text{ns}$)

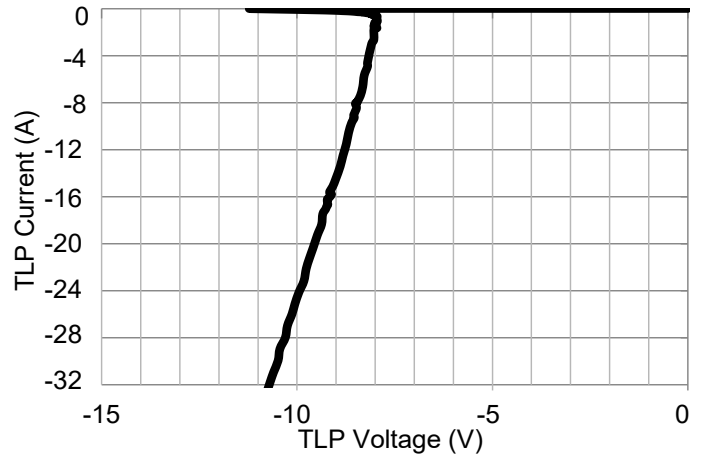

Typical Variations of C_J vs. Input Voltage
(Any I/O Pin to Pin)

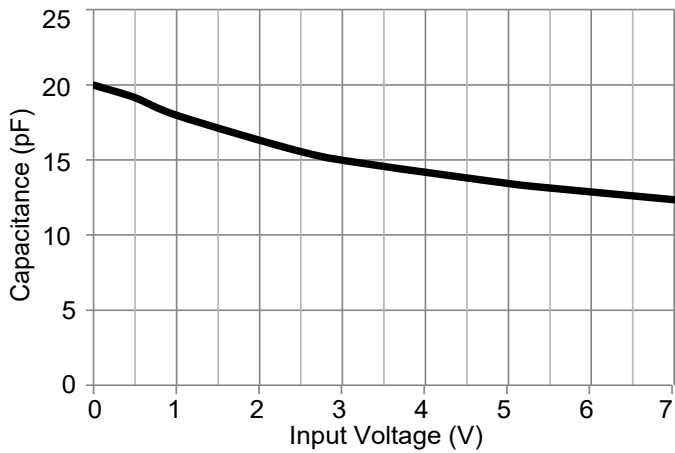

IEC61000-4-5 Surge 8/20 μs
(Any I/O Pin to Pin)

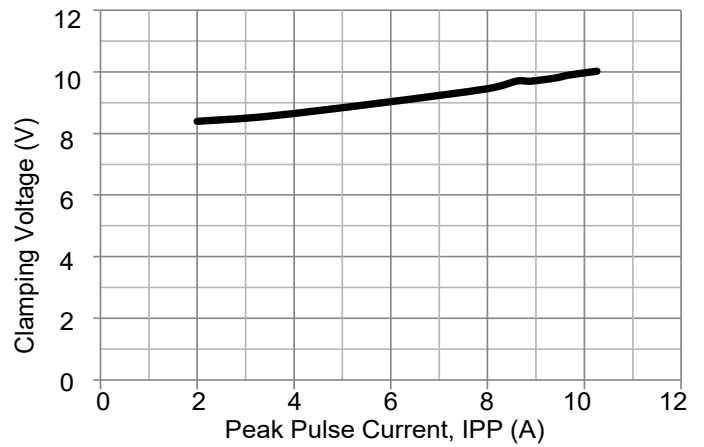

LEGAL DISCLAIMER

Applications or uses as critical components in life support devices or systems are not authorized. AOS does not assume any liability arising out of such applications or uses of its products. AOS reserves the right to make changes to product specifications without notice. It is the responsibility of the customer to evaluate suitability of the product for their intended application. Customer shall comply with applicable legal requirements, including all applicable export control rules, regulations and limitations.

AOS' products are provided subject to AOS' terms and conditions of sale which are set forth at:

http://www.aosmd.com/terms_and_conditions_of_sale

LIFE SUPPORT POLICY

ALPHA AND OMEGA SEMICONDUCTOR PRODUCTS ARE NOT AUTHORIZED FOR USE AS CRITICAL COMPONENTS IN LIFE SUPPORT DEVICES OR SYSTEMS.

As used herein:

1. Life support devices or systems are devices or systems which, (a) are intended for surgical implant into the body or (b) support or sustain life, and (c) whose failure to perform when properly used in accordance with instructions for use provided in the labeling, can be reasonably expected to result in a significant injury of the user.
2. A critical component in any component of a life support, device, or system whose failure to perform can be reasonably expected to cause the failure of the life support device or system, or to affect its safety or effectiveness.

单击下面可查看定价，库存，交付和生命周期等信息

[>>AOS\(万代\)](#)