



可控硅光耦
Photo Triac

AT MOC3021SM

Product Data Sheet

AOTE DCC
RELEASE

台湾奥特半导体科技有限公司

TAIWAN AOTE SEMICONDUCTOR TECHNOLOGY CO.,LTD

www.aotesemi.com

概述 Description

- MOC3021SM器件是由一个 GaAs 红外发光二极管和一个单晶硅芯片的过零相位光电双向晶闸管组成的光电耦合器。

The MOC3021SM series devices are optocouplers composed of a GaAs infrared light emitting diode and a single-crystal silicon chip random phase photoelectric bidirectional thyristor.

特性 Features

- 峰值击穿电压
Peak breakdown voltage
400V : MOC302X ;
- 输入-输出隔离电压 ($V_{ISO}=5000$ Vrms)
High isolation voltage between input and output($V_{ISO}=5000$ Vrms)
- 工作温度： -55°C ~110°C
Operating Temperature: -55°C ~110°C
- 符合加强绝缘标准
Meet reinforced insulation standards
- 符合安规标准： UL 1577 , VDE DIN EN60747-5-5 (VDE 0884-5) , CQC11-471543-2022
Safety standard approval: UL 1577, VDE DIN EN60747-5-5 (VDE 0884-5) , CQC11-471543-2022

应用 Applications

- 开关电源， 智能电表
Switching power supply, intelligent meter
- 工业控制， 测量仪器
Industrial control, measuring instruments
- 办公设备， 比如复印机
Office equipment such as copiers
- 家用电器， 比如空调、风扇、热水器等
Household appliances: such as air conditioners, fans, water heaters, etc.

封装和原理图 Package and Schematic Diagram



DIP6



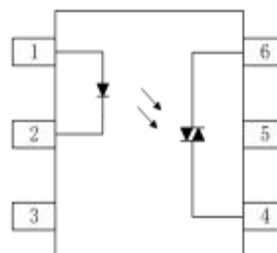

SMD6



Pin Configuration

- 1. Anode
- 2. Cathode
- 3. NC
- 4. GND
- 5. NC
- 6. VCC

印字信息 Marking Information

- 印字中 “” 为奥特品牌 LOGO
“” denotes LOGO
- 印字中 “Y” 代表年份； A(2018),B(2019),C(2020)
“Y” denotes YEAR： A(2018), B(2019), C(2020)
- 印字中 “WW” 代表周号
“WW” denotes Week’ s number
- 印字中 “E” 代表内部代码
“E” denotes Internal code
- 印字中的 “H” 代表无卤
“H” denotes Halogen-free



绝缘和安规信息 Insulation and Safety related specifications

项目 Item	符号 Symbol	数值 Value	单位 Unit	备注 Remark
爬电距离 Creepage Distance	L	>7.0	mm	从输入端到输出端，沿本体最短距离路径 Measured from input terminals to output terminals, shortest distance path along body
电气间隙 Clearance Distance	L	>7.0	mm	从输入端到输出端，通过空气的最短距离 Measured from input terminals to output terminals, shortest distance through air
绝缘距离 Insulation Thickness	DTI	>0.4	mm	发射器和探测器之间的绝缘厚度 Insulation thickness between emitter and detector
峰值隔离电压 Peak Isolation Voltage	V_{IORM}	1500	V_{peak}	DIN/EN/IEC EN60747-5-5
瞬态隔离电压 Transient isolation voltage	V_{IOTM}	7000	V_{peak}	DIN/EN/IEC EN60747-5-5
隔离电压 Isolation Voltage	V_{iso}	>5000	Vrms	For 1 min

极限参数 Absolute Maximum Ratings (Ta = 25°C)

参数 Parameter		符号 Symbol	额定值 Rating	单位 Unit
发射端 Input	正向电流 Forward Current	I_F	60	mA
	反向电压 Backward Voltage	V_R	6	V
	功耗 Power Dissipation	P_D	100	mW
	额定值降低因子(在 Ta = 90°C 以上) Power dissipation Derating factor (above Ta = 90°C)	P_{DD}	3.8	mW/°C
接收端 output	断态输出端电压 Off-state output terminal voltage	MOC301X	250	V
		MOC302X	400	
		MOC305X	600	
	峰值重复浪涌电流(pw=100μs,120pps) Peak repetitive surge current (pw=100μs,120pps)	I_{TSM}	1	A
	开启态电流 (均方根值) On-state current (root mean square value)	$I_{T(RMS)}$	100	mA
	功耗 Power Dissipation	P_C	300	mW
	额定值降低因子(在 Ta = 85°C 以上) Power dissipation Derating factor (above Ta = 90°C)		7.4	mW/°C
总功耗 Total Power Dissipation	P_{tot}	330	mW	
工作温度 Operating Temperature	T_{opr}	-55~110	°C	

参数 Parameter	符号 Symbol	额定值 Rating	单位 Unit
存储温度 Storage Temperature	T _{stg}	-55 ~125	°C
焊接温度 Soldering Temperature	T _{sol}	260	°C

*在相对湿度 40% ~ 60%下的进行交流电测试，此时 1、2 和 3 脚短接，4、5 和 6 脚短接。

* Conduct AC test at 40% ~60% relative humidity. At this time, pins 1, 2 and 3 are short-circuited, and pins 4, 5 and 6 are short-circuited.

产品特性参数 Electro-optical Characteristics (Ta = 25°C)

参数 Parameter		符号 Symbol	条件 Condition	最小 Min.	典型 Typ.	最大 Max.	单位 Unit	
发射端 Input	正向电压 Forward Voltage	V_F	$I_F = 20\text{mA}$	-	1.23	1.5	V	
	反向电流 Back current	I_R	$V_R = 6\text{V}$	-	-	10	μA	
接收端 Output	断态峰值电流 Off-state peak current	I_{DRM}	$V_{\text{DRM}} = \text{Rated } V_{\text{DRM}}$ $I_F = 0\text{mA}$	-	-	100	nA	
	通态峰值电压 On-state peak voltage	V_{TM}	$I_{\text{TM}} = 100\text{mA peak}$ $I_F = \text{Rated } I_{\text{FT}}$	-	-	2.5	V	
	断态电压临界上升率 Critical rise rate of off-state voltage	MOC301X	dv/dt	$V_{\text{PEAK}} = \text{Rated } V_{\text{DRM}}$ $I_F = 0$	-	100	-	$\text{V}/\mu\text{s}$
		MOC302X						
MOC305X		$V_{\text{PEAK}} = 400\text{V}, I_F = 0$						
传输特性 Transfer Characteristics	LED 触发电流 LED trigger current	MOC3020	I_{FT}	主端电压 Main terminal Voltage =3V	-	-	mA	
		MOC3011						
		MOC3021						
		MOC3051						
		MOC3012						
		MOC3022						
		MOC3052						
		MOC3013						
		MOC3023						
	MOC3053							
维持电流 Maintain current	I_H	-	-	250	-	μA		

典型光电特性曲线 Typical Electro-Optical Characteristics Curves

Fig.1 LED forward current vs Forward voltage

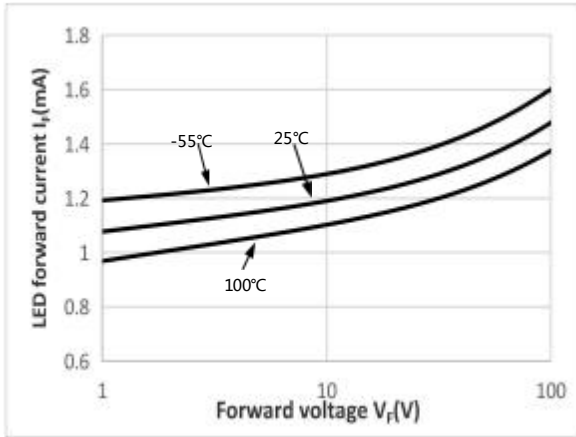

Fig.2 On-state characteristic diagram

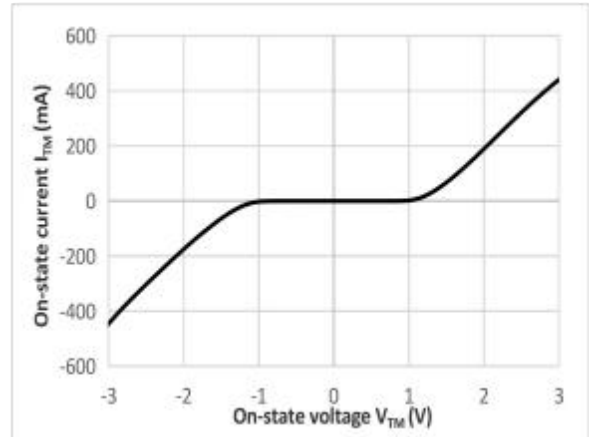

Fig.3 Trigger current vs Ambient temperature

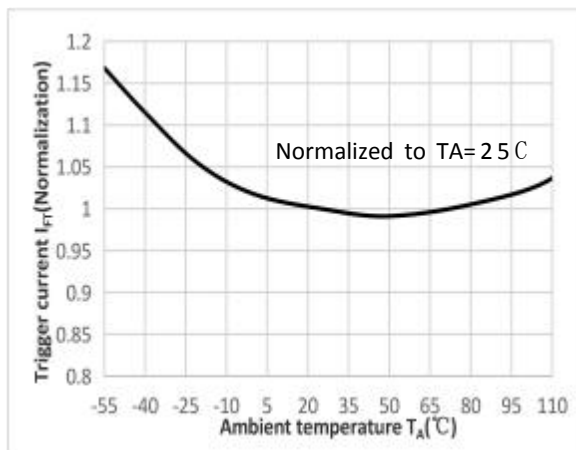

Fig.4 Trigger current vs LED pulse width

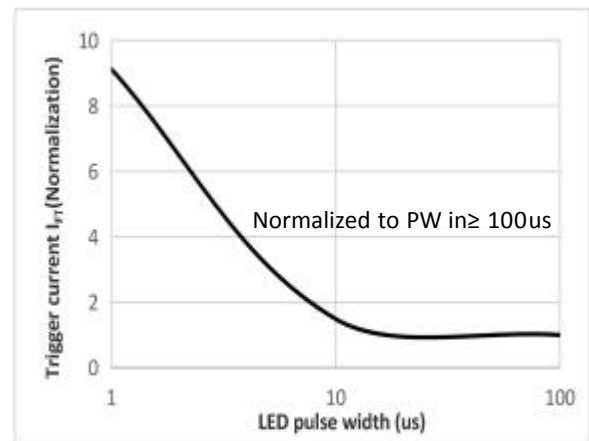

Fig.5 Maintenance current vs Ambient temperature

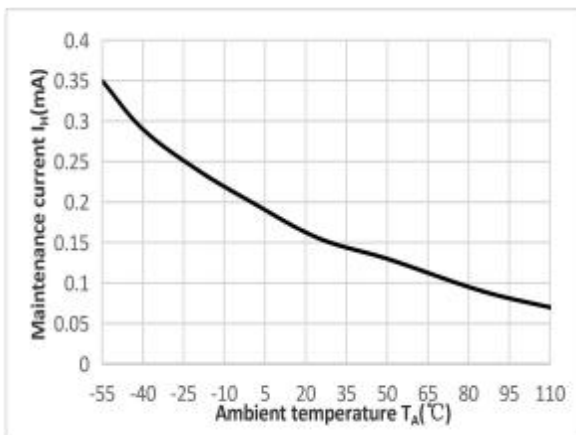

Fig.6 Leakage current vs Ambient temperature

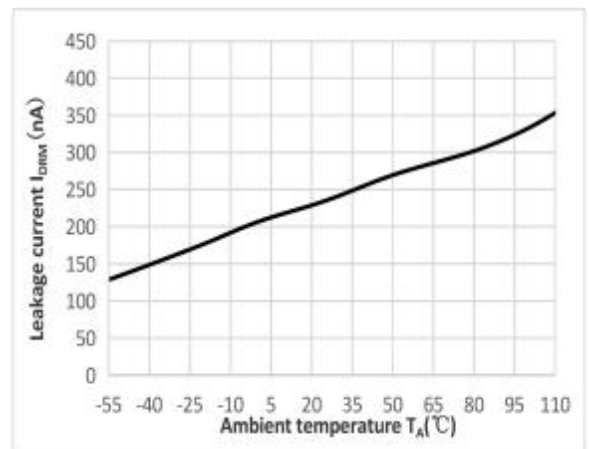

Fig.7 静态 dv/dt 测试电路和波形 Static dv/dt test circuit and waveform



通过 RC 电路施加于被测器件的输出端的高电压脉冲设置到所需的 V_{PEAK} 值上。LED 电流无需加上。波形 V_T 使用 X100 探头监测。通过调节 R_{TEST} 值，dv/dt (斜度) 增加，直到被测器件观察到被触发 (波形崩溃)。dv/dt 然后下降，直到被测器件停止被触发。此时，记录 τ_{RC} 值并可计算 dv/dt 了。

The high voltage pulse applied to the output end of the device under test through the RC circuit is set to the desired V_{PEAK} value. LED current does not need to be added. Waveform V_T is monitored with X100 probe. By adjusting the R_{TEST} value, dv/dt (slope) increases until the device under test is observed to be triggered (waveform collapse). Dv/dt then drops until the device under test stops being triggered. At this time, dv/dt can be calculated by recording the value of τ_{RC}.

$$dv/dt = \frac{0.632 \times 400}{\tau_{RC}} = \frac{252}{\tau_{RC}}$$

例如，AT302X 系列的电压峰值 = 400V。dv/dt 值的计算方式如下：

For example, the voltage peak of AT304X series V_{PEAK}=400V. Then the dv/dt value can be calculated as follows :

$$dv/dt = \frac{0.632 \times 400}{\tau_{RC}} = \frac{252}{\tau_{RC}}$$

外形尺寸 Outline Dimensions

DIP6

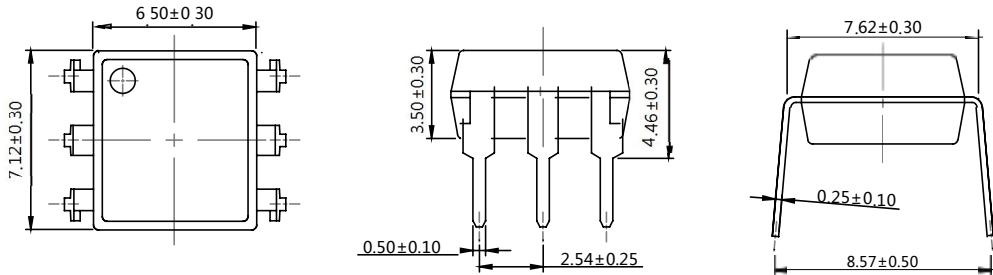

SMD6

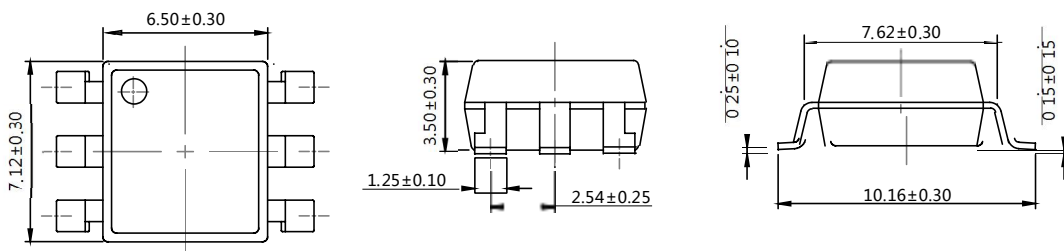

单位 Unit: mm

建议焊盘布局 Recommended Pad Layout

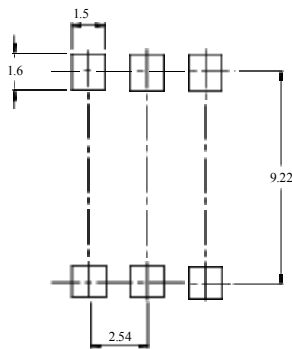

单位 Unit: mm

注：上图为产品正视图。

Note: The picture above is the front view of the product.

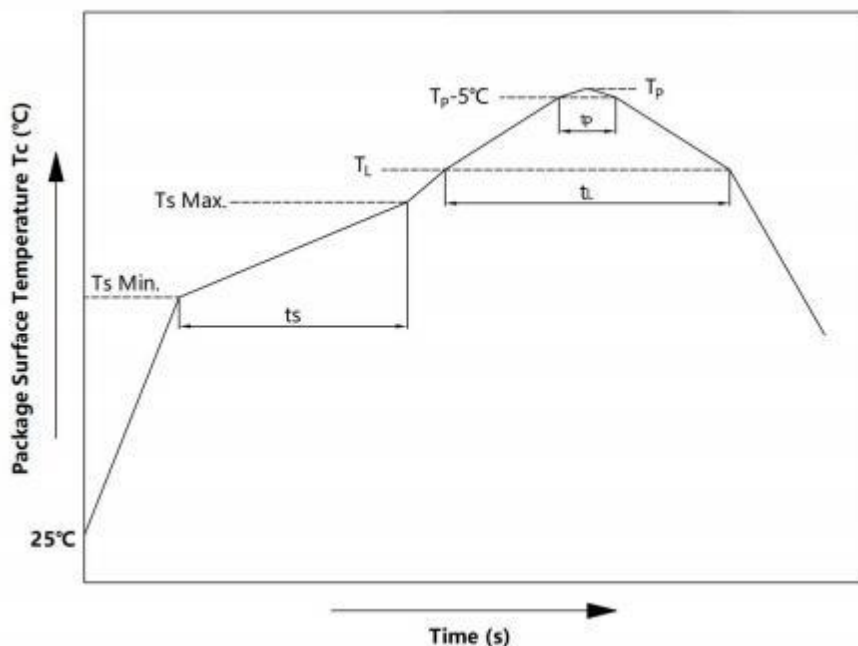
回流焊温度曲线图 Solder Reflow Profile

项目 Item	符号 Symbol	最小值 Min.	最大值 Max.	单位 Unit
预热温度 Preheat Temperature	Ts	150	200	°C
预热时间 Preheat Time	ts	60	120	s
升温速率 Ramp-Up Rate (T _L to T _P)	-	-	3	°C/s
液相线温度 Liquidus Temperature	T _L	217		°C
时间高于 T _L Time Above T _L	t _L	60	150	s
峰值温度 Peak Temperature	T _P	-	260	°C
Tc 在(T _P -5)和 T _P 之间的时间 Time During Which Tc Is Between (T _P -5) and T _P	t _p	-	30	s
降温速率 Ramp-down Rate(T _P to T _L)	-	-	6	°C/s

注 Note :

建议在所示的温度和时间条件下进行回流焊，最多不能超过三次；

Reflow soldering is recommended at the temperatures and times shown, no more than three times;

波峰焊温度曲线图 Wave Soldering Profile



手工烙铁焊接 Soldering with hand soldering iron

- A. 手工烙铁焊仅用于产品返修或样品测试；
Hand soldering iron is only used for product rework or sample testing;
- B. 手工烙铁焊要求：温度 $360^{\circ}\text{C} \pm 5^{\circ}\text{C}$ ，时间 $\leq 3\text{s}$ 。
Hand soldering iron requirements：Temperature： $360^{\circ}\text{C} \pm 5^{\circ}\text{C}$, within 3s

包装 Packing

■ 汇总表 Summary table

封装形式	包装方式	盘数量	盒数量	箱数量	静电袋规格	盒规格	箱(双瓦楞)规格	备注
Package Type	Packing Form	Quantity per Reel	Quantity per Box	Quantity per Carton	Antistatic Bag Specification	Box Specification	Carton Specification	Note
DIP6	管装 (500*12*11mm)	65 只/管	50 管/盒	10 盒/箱	不适用	525*128*56mm	535*275*300mm	每管使用蓝白胶塞，方向须一致
SMD6	卷盘 (φ330mm 蓝盘)	1000/盘	2 盘/盒	10 盒/箱	450*390*0.1mm	340*60*340mm	380*360*365mm	首尾端空至少200mm
DIP6	Tube (500*12*11mm)	65 pcs /Tube	50 Tubes /box	10 boxes /ctn	Not applicable	525*128*56mm	535*275*300mm	Use blue and white rubber stoppers for each tube, with the same direction
SMD6	Reel (φ330mm Blue)	1k pcs/reel	2 reels /box	10 boxes /ctn	450*390*0.1mm	340*60*340mm	380*360*365mm	Leave at least 200mm of blank space at both ends

■ 管条包装 Tape & Tube

- 1) 每管数量：65 只。
Qty/Tube：65 pcs.
- 2) 每箱数量：32500 只。
Qty/ctn：32500 pcs.
- 3) 内包装：每盒 50 管。
Inner packing：50 Tube/box.
- 4) 示意图 Schematic：

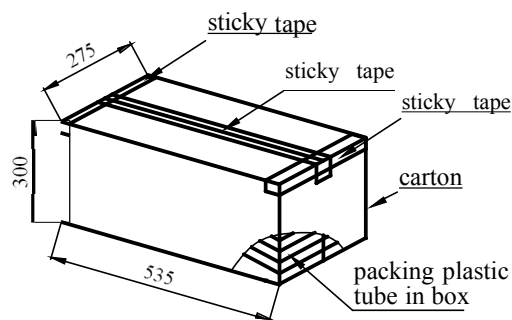
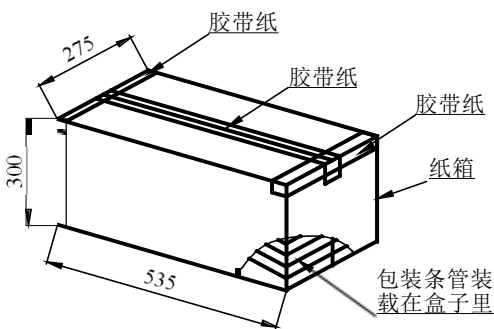

■ 编带包装 Tape & Reel

- 1) 每卷数量：1000 只。
Qty/reel：1000 pcs.
- 2) 每箱数量：20000 只。
Qty/ctn：20000 pcs.
- 3) 内包装：每盒 2 盘。
Inner packing：2 reels/box.
- 4) 示意图 Schematic：



单位 Unit：mm

注意 Attention

- 奥特持续不断改进质量、可靠性、功能或设计，保留此文件更改的权利恕不另行通知。
AOTE continuously improve quality, reliability, function and design. We reserve the right to change this document without prior notice.
- 请遵守产品规格书使用，奥特不对使用时不符合产品规格书条件而导致的质量问题负责。
Please use in accordance with the product specification. AOTE is not responsible for the quality problems caused by non-compliance with the product specifications.
- 对于需要高可靠性或安全性的设备/装置需求，请联系我们的销售人员。
For equipment/devices requiring high reliability or safety, please contact our sales representatives.
- 当需要用于任何“特定”应用时，请咨询我们的销售人员。
When requiring a device for any “specific” application, please contact our sales in advice.
- 如对文件中表述的内容有疑问，欢迎联系我们。
If you have any questions about the contents of the document, please contact us.

单击下面可查看定价，库存，交付和生命周期等信息

[>>AOTE\(奥特\)](#)