



高速光耦
High Speed Photo
Coupler

AT075L

Product Data Sheet

AOTE DCC
RELEASE

台湾奥特半导体科技有限公司

TAIWAN AOTE SEMICONDUCTOR TECHNOLOGY CO.,LTD

www.aotesemi.com

概述 Description

双通道 AT075L 由高速 LED 和 CMOS 检测芯片组成。最低数据传输速率达 15Mbit/s，具有卓越的高速性能和超低功耗。

Basic building blocks of AT075L (dual-channel) is high speed LEDs and CMOS detector ICs. It is 15Mbit/s CMOS opto-couplers. The optocouplers use the latest CMOS IC technology to achieve outstanding performance with very low power consumption.

特性 Features

- 高速响应 15 MBit/s
Very high speed – 15MBit/s
- 宽工作温度：-40°C ~105°C
-40°C to 105°C temperature range
- SOP8 封装
Packaging: SOP8
- 共模抑制能力至少达 10 kV/μs
10 kV/μs minimum common mode rejection
- 无短时脉冲电源启动功能
No short-time pulse power start function
- 符合安规标准：UL 1577，VDE DIN EN60747-5-5 (VDE 0884-5)，CQC11-471543-2022
Meet Safety standard：UL 1577, VDE DIN EN60747-5-5 (VDE 0884-5)，CQC11-471543-2022

应用 Applications

- 数字现场总线隔离
Digital field bus isolation
- 多路复用数据传输
Multiplexed data transmission
- 电脑外设接口
Computer peripheral interface
- 微处理器系统接口
Microprocessor system interface
- 直流/直流转换器
DC/DC converter

真值表 Truth table

LED	VO
OFF	H
ON	L

封装和原理图 Package and Schematic Diagram



SOP8

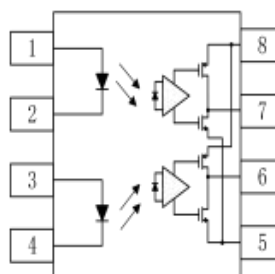

Pin Configuration

- | | |
|--------------|--------|
| 1. Anode 1 | 8.VCC |
| 2. Cathode 1 | 7.VO 1 |
| 3. Cathode 2 | 6.VO 2 |
| 4. Anode 2 | 5.GND |

注：在引脚 5 和 8 之间必须连接一个 0.01 - 0.1uF 的旁路电容器。



Note: 0.01 - 0.1uF bypass capacitor must be connected between pins 5 and 8.

产品型号命名规则 Order Code
AT 075L - UN Y - W (V) (ZZ)

① ② ③ ④ ⑤ ⑥ ⑦

- ① 公司代码 Company Code (AT: 奥特 Aote)
- ② 产品系列 Product Series (075L)
- ③ 框架类型 Lead Frame (Cu: 铜框架 Copper)
- ④ 树脂类型 Epoxy Type (H: 无卤 Halogen-free)
- ⑤ 封装形式 Package (S: SOP)
- ⑥ 器件工作温度范围 Device Operating Temperature Range (特殊范围需填或者空白 Special Range need to be filled in or left blank)
- ⑦ 内部补充代码 Internal Supplementary Code (数字或者空白 Number or None)

印字信息 Marking Information

- 印字中 “” 为奥特品牌 LOGO
“” denotes LOGO
- 印字中 “Y” 代表年份； A(2018),B(2019),C(2020)
“Y” denotes YEAR： A(2018), B(2019), C(2020)
- 印字中 “WW” 代表周号
“WW” denotes week' s number
- 印字中 “E” 代表内部代码
“E” denotes Internal code
- 印字中的 “H” 代表无卤
“H” denotes Halogen-free

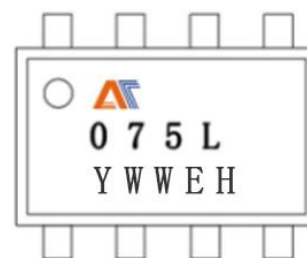

绝缘和安规信息 Insulation and Safety related specifications

项目 Item	符号 Symbol	数值 Value	单位 Unit	备注 Remark
爬电距离 Creepage Distance	L	> 5.0	mm	从输入端到输出端，沿本体最短距离路径 Measured from input terminals to output terminals, shortest distance path along body
电气间隙 Clearance Distance	L	> 5.0	mm	从输入端到输出端，通过空气的最短距离 Measured from input terminals to output terminals, shortest distance through air
绝缘距离 Insulation Thickness	DTI	> 0.4	mm	发射器和探测器之间的绝缘厚度 Insulation thickness between emitter and detector
峰值隔离电压 Peak Isolation Voltage	V_{IORM}	600	V_{peak}	DIN/EN/IEC EN60747-5-5
瞬态隔离电压 Transient isolation voltage	V_{IOTM}	5000	V_{peak}	DIN/EN/IEC EN60747-5-5
隔离电压 Isolation Voltage	V_{iso}	> 3750	Vrms	For 1 min

极限参数 Absolute Maximum Ratings (Ta = 25°C)

参数 Parameter		符号 Symbol	最小值 Min.	最大值 Max.	单位 Unit
输入 Input	正向电流 Forward Current	I_F	-	20	mA
	功耗 Power Dissipation	P_D	-	35	mW
输出 Output	电源电压 Supply Voltage	V_{DD}	-	6	V
	输出电流 Output Current	I_O	-	10	mA
	输出电压 Output Voltage	V_O	-0.5	VDD+0.5	V
	功耗 Power Dissipation	P_O	-	100	mW
隔离电压 Isolation voltage		V_{iso}	-	3750	Vrms
工作温度 Operating Temperature		T_{opr}	-40	+105	°C
存储温度 Storage Temperature		T_{stg}	-55	+125	°C
焊接温度 Soldering Temperature		T_{sol}	-	+260	°C

推荐工作条件 Recommended Operating Conditions

参数 Parameter	符号 Symbol	最小值 Min.	最大值 Max.	单位 Unit
电源电压 Supply Voltages	V_{DD}	4.5	5.5	V
		3	3.6	V
开启电流 Forward Input Current (ON)	$I_{F(ON)}$	9	18	mA
操作温度 Operating Temperature	T_A	-40	105	°C
电压转化速率 Supply Voltage Slew Rate	S_R	0.5	500	V/ms

产品特性参数 Electro-optical Characteristics ($T_a = 25^\circ\text{C}$, $V_{DD} = 3.3\text{V}$)

参数 Parameter	符号 Symbol	条件 Condition	最小 Min.	典型 Typ.	最大 Max.	单位 Unit	
发射端 Input	正向电压 Forward Voltage	V_F	$I_F = 14\text{mA}$	1.3	1.46	1.8	V
	反向击穿电压 Reverse Breakdown Voltage	B_{VR}	$I_R = 10\mu\text{A}$	5	35	-	V
接收端 Output	高电平输出电压 High Level Output Voltage	V_{OH}	$I_F = 0, I_O = -4\text{mA}, V_{DD} = 5\text{V}$	$V_{DD} - 1$	4.85	-	V
			$I_F = 0, I_O = -4\text{mA}, V_{DD} = 3.3\text{V}$	$V_{DD} - 1$	3.1	-	V
	低电平输出电压 Low Level Output Voltage	V_{OL}	$I_F = 14\text{mA}, I_O = 4\text{mA}, V_{DD} = 5\text{V}$	-	0.07	0.8	V
			$I_F = 14\text{mA}, I_O = 4\text{mA}, V_{DD} = 3.3\text{V}$	-	0.08	0.8	V
	输入阈值电流 Input Threshold Current	I_{TH}	$I_{OL} = 20\mu\text{A}$	-	3	5	mA
	高电平电源电流 High Output Supply Current	I_{DDH}	$I_F = 0$	-	9.4	12	mA
	低电平电源电流 Low Output Supply Current	I_{DDL}	$I_F = 14\text{mA}$	-	9.05	12	mA

开关特性 Switching Specification

参数 Parameter	符号 Symbol	条件 Condition	最小 Min.	典型 Typ.	最大 Max.	单位 Unit
逻辑高电平传播延迟 Propagation Delay Time to Logic High Output Level	T_{PLH}	$I_F=14mA, C_L=15 pF$ $V_{DD}=3.3V$	-	62	80	ns
		$I_F=14mA, C_L=15 pF$ $V_{DD}=5V$	-	-	80	ns
逻辑低电平传播延迟 Propagation Delay Time to Logic Low Output Level	T_{PHL}	$I_F=14mA, C_L=15 pF,$ $V_{DD}=3.3V$	-	28	80	ns
		$I_F=14mA, C_L=15 pF,$ $V_{DD}=5V$	-	-	80	ns
脉冲宽度 Pulse Width	T_{pw}		66.7	-	-	ns
脉宽失真 Pulse Width Distortion	$ T_{PLH}-T_{PHL} $	$I_F=14mA, C_L=15 pF,$ $V_{DD}=3.3V$	-	34	40	ns
		$I_F=14mA, C_L=15 pF,$ $V_{DD}=5V$	-	-	40	ns
上升时间 (10%-90%) Rise Time (10%-90%)	T_r	$I_F=14mA, C_L=15 pF$	-	6	-	ns
下降时间 (90%-10%) Fall Time (90%-10%)	T_f	$I_F=14mA, C_L=15 pF$	-	4	-	ns
传输延迟差 $ T_{PLH}-T_{PHL} $ Propagation Delay Skew $ T_{PLH}-T_{PHL} $	T_{PSK}	$I_F=14mA, C_L=15 pF$	-	-	30	ns
输出高电平共模抑制 Logic High Common Mode Transient Immunity	$ CM_H $	$I_F=0mA$ $T_A=25^{\circ}C,$ $ V_{CM} =1kV$	10	15	-	kV/us
输出低电平共模抑制 Logic Low Common Mode Transient Immunity	$ CM_L $	$I_F=14mA$ $T_A=25^{\circ}C,$ $ V_{CM} =1kV$	10	15	-	kV/us
隔离电阻 Isolation resistance	R_{i-o}	$V_{iH}=500V,$ $40 \sim 60\%R.H.$	-	1012	-	Ω
隔离电容 Isolation Capacitance	C_{i-o}	$V=0, F=1MHz$	-	0.6	-	pF

典型光电特性曲线 Typical Electro-Optical Characteristics Curves

Fig.1 Forward current vs. Forward Voltage

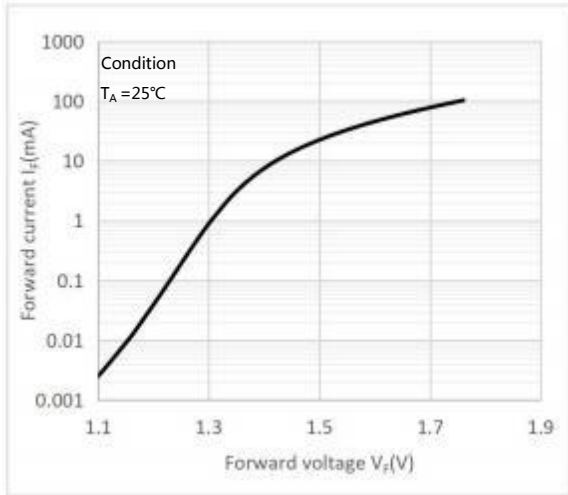

Fig.2 Input threshold current vs. Ambient temperature

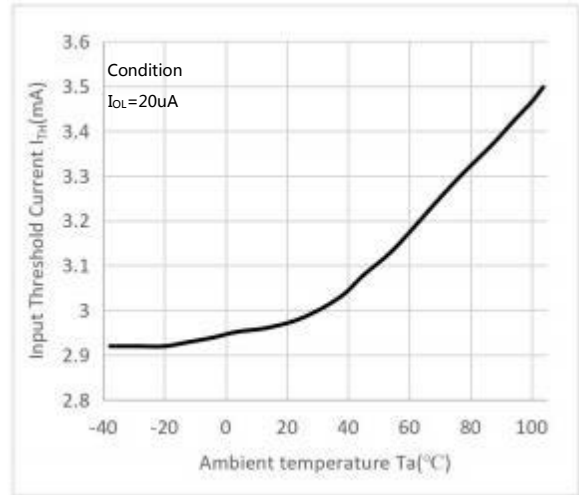

Fig.3 High output supply current vs. Ambient temperature

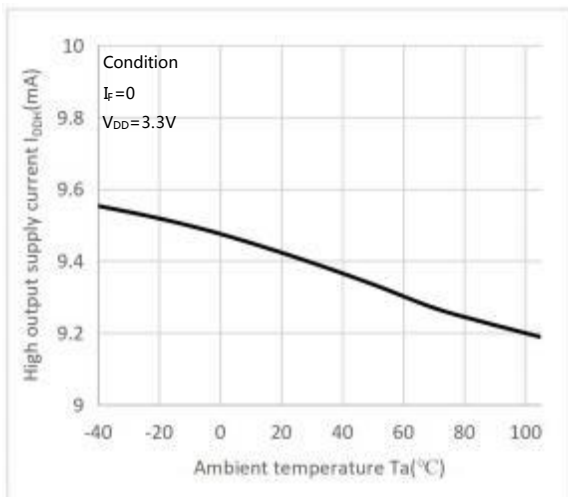

Fig.4 Low output supply current vs. Ambient temperature

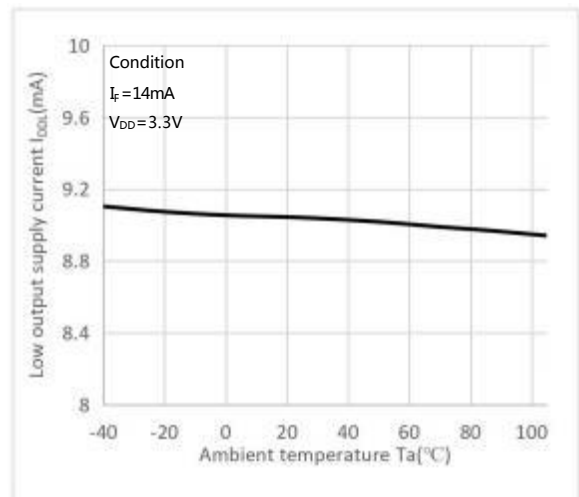

Fig.5 Propagation delay vs. Pulse input current

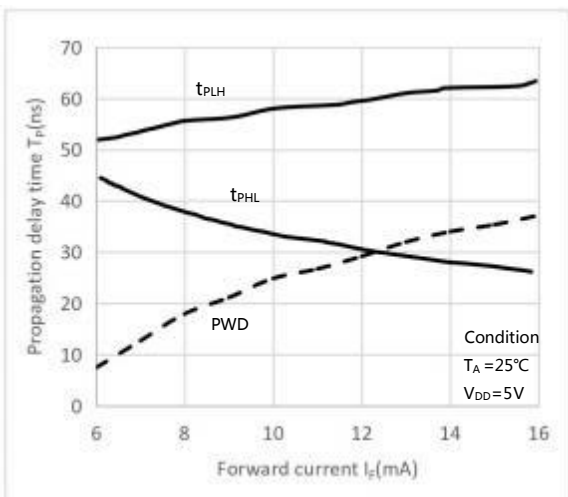

Fig.6 Propagation delay vs. Pulse input current

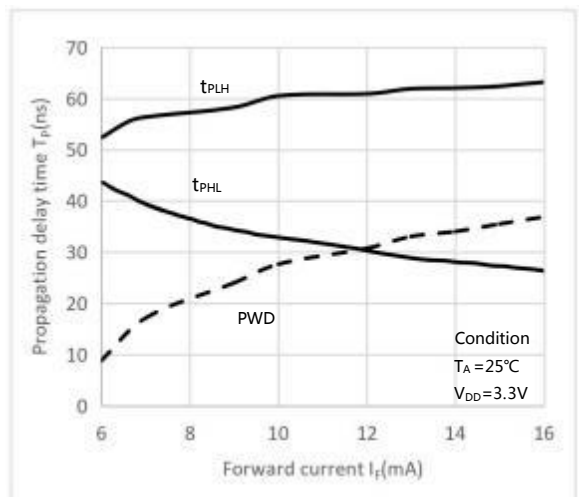

Fig.7 Forward voltage vs. Ambient temperature

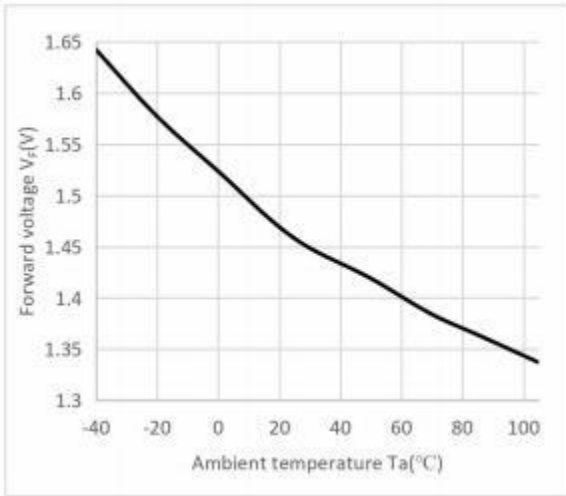

Fig.8 Propagation delay vs. Ambient temperature

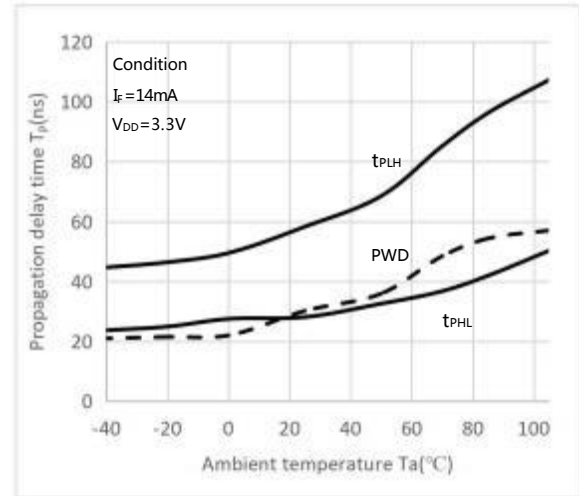
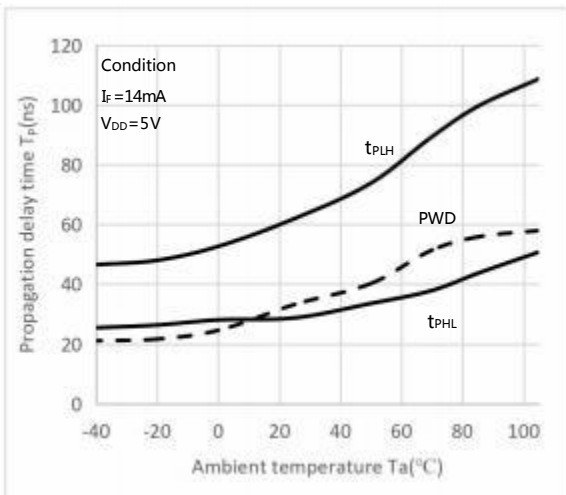
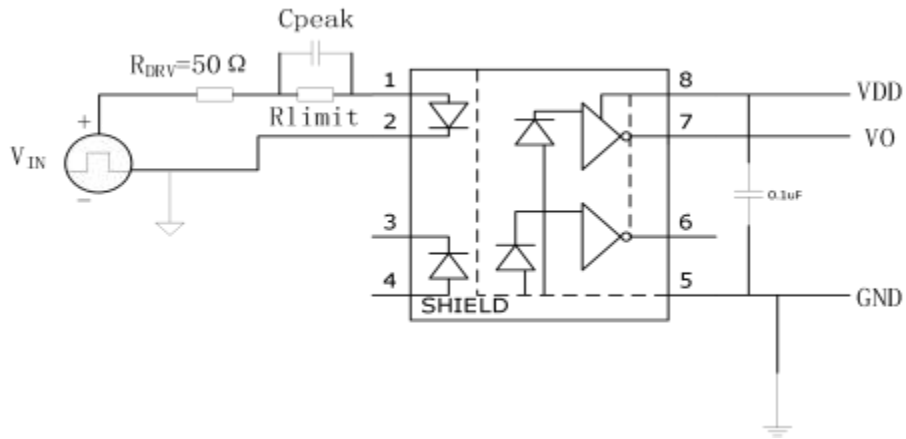

Fig.9 Propagation delay vs. Ambient temperature



延迟时间测试电路 Propagation Delay Time Test Circuit



$V_{DD}=3.3V / 5V, C_{peak}=100pF, R_{limit}=80\Omega / 210\Omega$

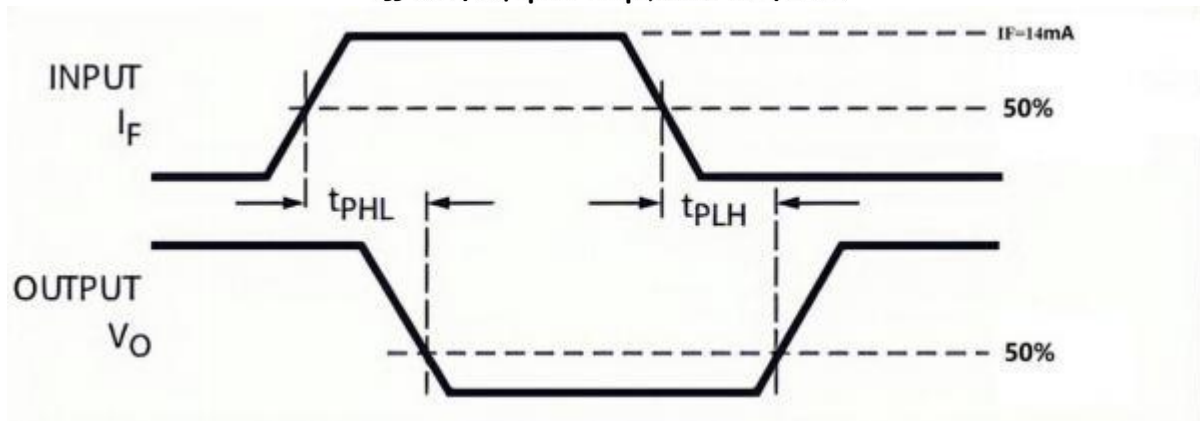

CMR 测试电路 Test Circuit for Common Mode Transient Immunity

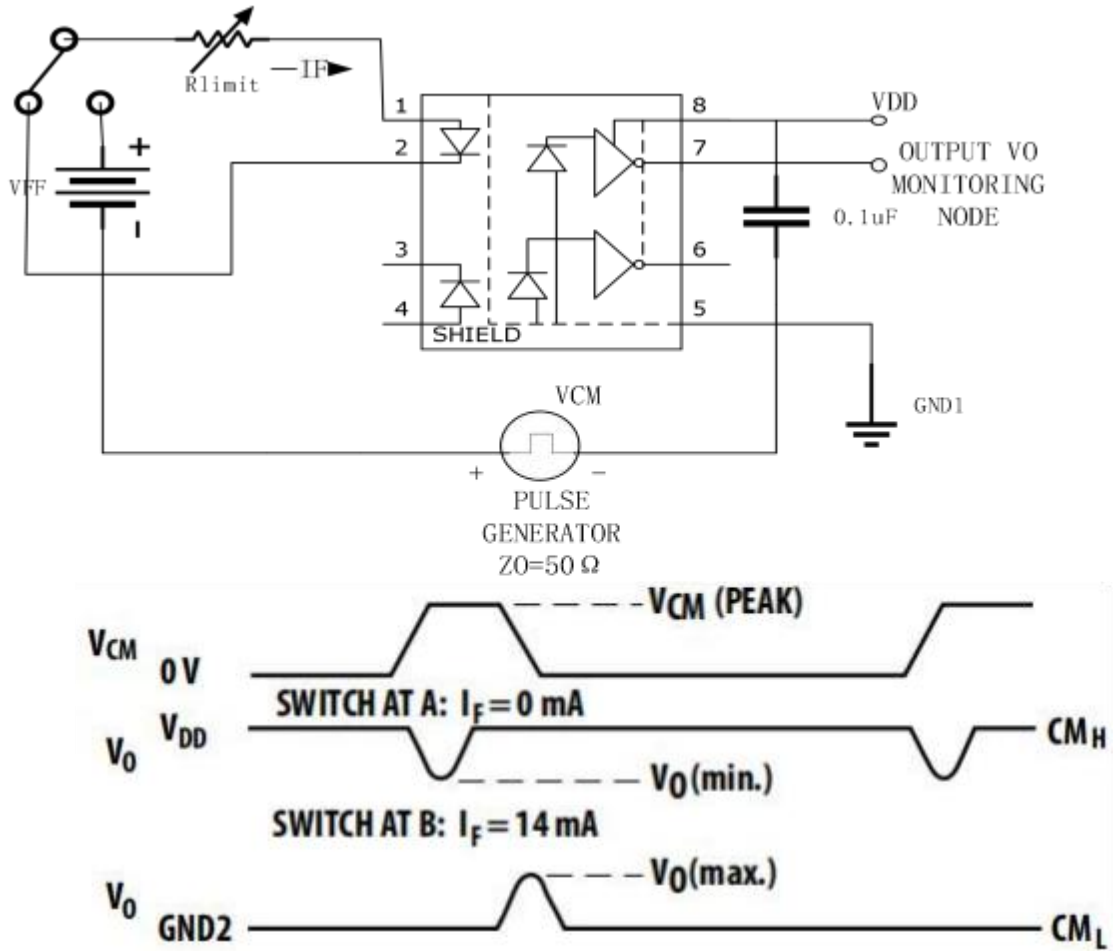

外形尺寸 Outline Dimensions

SOP8

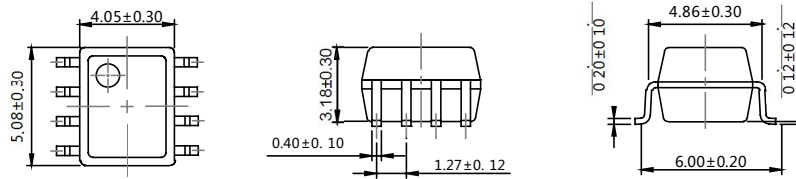

单位 Unit: mm

建议焊盘布局 Recommended Pad Layout

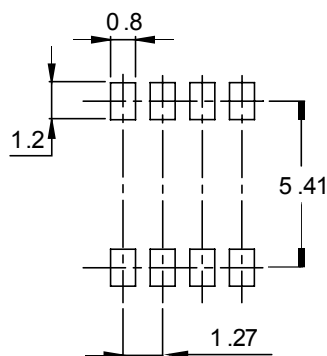

单位 Unit: mm

注：上图为产品正视图。

Note: The picture above is the front view of the product.

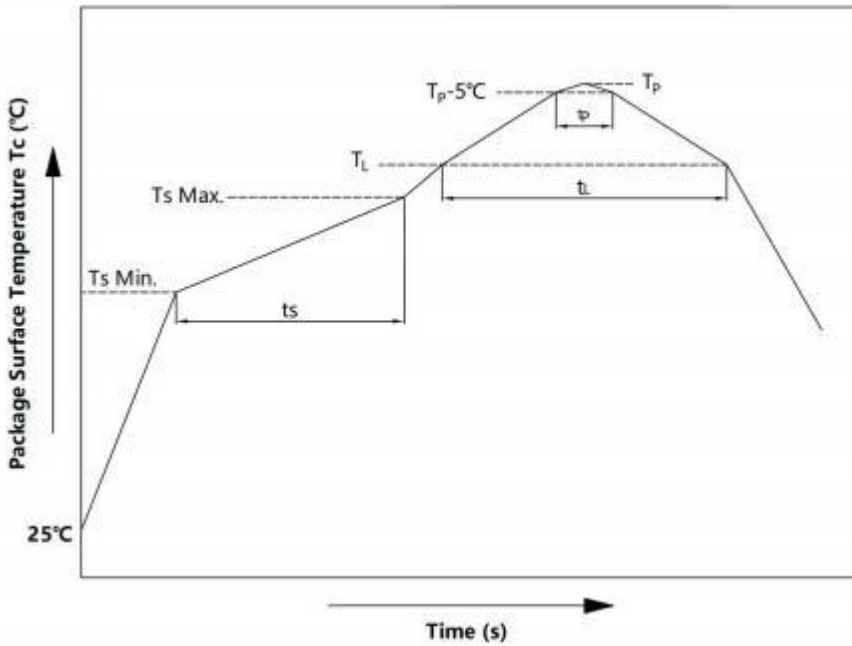
回流焊温度曲线图 Solder Reflow Profile

项目 Item	符号 Symbol	最小值 Min.	最大值 Max.	单位 Unit
预热温度 Preheat Temperature	Ts	150	200	°C
预热时间 Preheat Time	ts	60	120	s
升温速率 Ramp-Up Rate (T _L to T _P)	-	-	3	°C/s
液相线温度 Liquidus Temperature	T _L	217		°C
时间高于 T _L Time Above T _L	t _L	60	150	s
峰值温度 Peak Temperature	T _P	-	260	°C
Tc 在(T _P -5)和 T _P 之间的时间 Time During Which Tc Is Between (T _P -5) and T _P	t _p	-	30	s
降温速率 Ramp-down Rate(T _P to T _L)	-	-	6	°C/s

注 Note :

建议在所示的温度和时间条件下进行回流焊，最多不能超过三次；

Reflow soldering is recommended at the temperatures and times shown, no more than three times;

波峰焊温度曲线图 Wave Soldering Profile

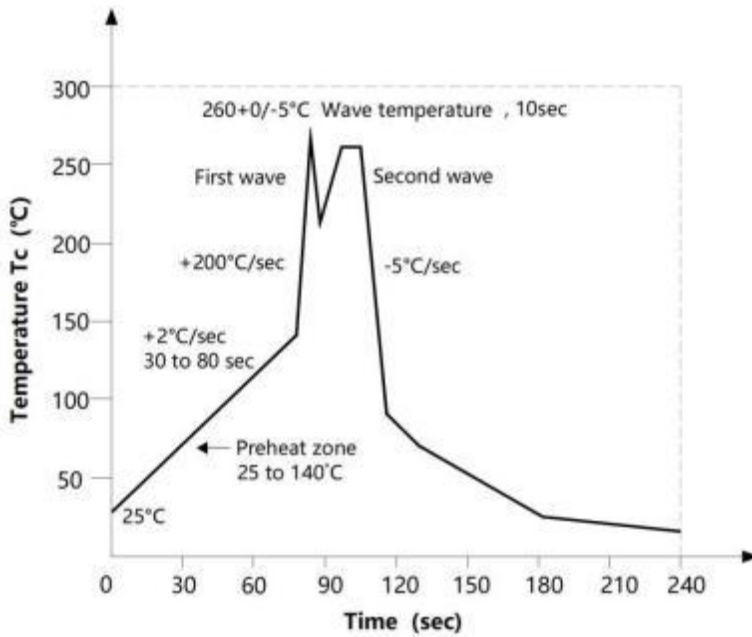

手工烙铁焊接 Soldering with hand soldering iron

- A. 手工烙铁焊仅用于产品返修或样品测试；
Hand soldering iron is only used for product rework or sample testing;
- B. 手工烙铁焊要求：温度 $360^{\circ}\text{C} \pm 5^{\circ}\text{C}$ ，时间 $\leq 3\text{s}$ 。
Hand soldering iron requirements：Temperature： $360^{\circ}\text{C} \pm 5^{\circ}\text{C}$, within 3s.

包装 Packing

■ 汇总表 Summary table

封装形式	包装方式	盘数量	盒数量	箱数量	静电袋规格	盒规格	箱(双瓦楞)规格	备注
SOP8	编带 ($\phi 330$ mm 蓝盘)	2k /盘	2 盘/盒	10 盒/箱	450*390*0.1mm	340*60*340mm	620*360*365mm	首尾端空至少 200mm
Package Type	Packing Form	Quantity per Reel	Quantity per Box	Quantity per Carton	Antistatic Bag Specification	Box Specification	Carton Specification	Note
SOP8	Reel ($\phi 330$ mm Blue)	2k pcs/reel	2 reels /box	10 boxes /ctn	450*390*0.1mm	340*60*340mm	620*360*365mm	Guard band 200mm min.

■ 编带包装 Tape & Reel

- 1) 每卷数量：2000 只。
Qty/reel：2000 pcs.
- 2) 每箱数量：40000 只。
Qty/ctn：40000 pcs.
- 3) 内包装：每盒 2 盘。
Inner packing：2reels/box
- 4) 示意图 Schematic：

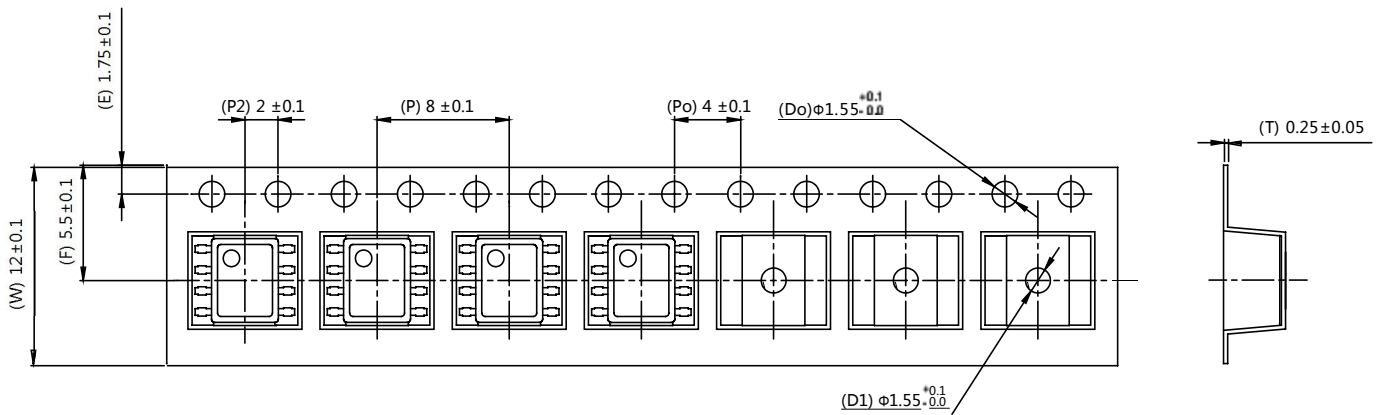

单位 Unit：mm

注意 Attention

- 奥特持续不断改进质量、可靠性、功能或设计，保留此文件更改的权利恕不另行通知。
AOTE continuously improve quality, reliability, function and design. We reserve the right to change this document without prior notice.
- 请遵守产品规格书使用，奥特不对使用时不符合产品规格书条件而导致的质量问题负责。
Please use in accordance with the product specification. AOTE is not responsible for the quality problems caused by non-compliance with the product specifications.
- 对于需要高可靠性或安全性的设备/装置需求，请联系我们的销售人员。
For equipment/devices requiring high reliability or safety, please contact our sales representatives.
- 当需要用于任何“特定”应用时，请咨询我们的销售人员。
When requiring a device for any “specific” application, please contact our sales in advice.
- 如对文件中表述的内容有疑问，欢迎联系我们。
If you have any questions about the contents of the document, please contact us.

单击下面可查看定价，库存，交付和生命周期等信息

[>>AOTE\(奥特\)](#)