



# 晶体管光耦 Photo Transistor

## LTV-217

Product Data Sheet

**AOTE DCC**  
**RELEASE**

**台湾奥特半导体科技有限公司**

TAIWAN AOTE SEMICONDUCTOR TECHNOLOGY CO.,LTD

[www.aotesemi.com](http://www.aotesemi.com)

## 概述 Description

LTV-217是一款由发光二极管和光电晶体管组成的光电耦合器。 四引脚封装（SSOP4）。

The LTV-217 is a photoelectric coupler composed of light-emitting diode and phototransistor. It is packaged in a 4-pin package at SSOP4.

## 特性 Features

- 电流转换比(CTR)范围:  $\geq 80\%$  ( $I_F = 5\text{mA}$ ,  $V_{CE} = 5\text{V}$ ,  $T_a = 25^\circ\text{C}$ )  
Current transfer ratio:  $\geq 80\%$  ( $I_F = 5\text{mA}$ ,  $V_{CE} = 5\text{V}$ ,  $T_a = 25^\circ\text{C}$ )
- 输入-输出隔离电压 ( $V_{ISO} = 3750 \text{ Vrms}$ )  
High isolation voltage between input and output ( $V_{ISO} = 3750 \text{ Vrms}$ )
- 集电极-发射极击穿电压  $BV_{CEO} \geq 80\text{V}$   
Collector - emitter breakdown voltage  $BV_{CEO} \geq 80\text{V}$
- 工作温度:  $-55^\circ\text{C} \sim 110^\circ\text{C}$   
Operating Temperature:  $-55^\circ\text{C} \sim 110^\circ\text{C}$
- 符合加强绝缘标准  
Meet reinforced insulation standards
- 符合安规标准: UL 1577, VDE DIN EN60747-5-5 (VDE 0884-5), CQC11-471543-2022  
Meet safety standard approval: UL 1577, VDE DIN EN60747-5-5 (VDE 0884-5), CQC11-471543-2022

## 应用 Applications

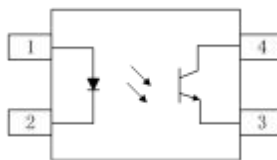

- 开关电源, 智能电表  
Switching power supply, intelligent meter
- 工业控制, 测量仪器  
Industrial control, measuring instruments
- 办公设备, 比如复印机  
Office equipment such as copiers
- 家用电器, 比如空调、风扇、热水器等  
Household appliances: such as air conditioners, fans, water heaters, etc.

## 封装和原理图 Package and Schematic Diagram



Pin Configuration

1. Anode
2. Cathode
3. Emitter
4. Collector

- 印字中 “” 为奥特品牌 LOGO  
“” denotes LOGO
- 印字中的 “X” 代表产品分档：A、B、C、D 或空白  
“X” denotes the classification：A、B、C、D or None
- 印字中 “Y” 代表年份；A(2018),B(2019),C(2020) ... ..  
“Y” denotes YEAR：A(2018), B(2019), C(2020) ... ..
- 印字中 “WW” 代表周号  
“WW” denotes Week’ s number
- 印字中 “E” 代表内部代码  
“E” denotes Internal code
- 印字中的 “H” 代表无卤  
“H” denotes Halogen-free



**绝缘和安规信息 Insulation and Safety related specifications**

| 项目<br>Item                            | 符号<br>Symbol | 数值<br>Value | 单位<br>Unit | 备注<br>Remark   |
|---------------------------------------|--------------|-------------|------------|--|
| 爬电距离<br>Creepage Distance             | L            | > 5.0       | mm         | 从输入端到输出端，沿本体最短距离路径<br>Measured from input terminals to output terminals, shortest distance path along body |
| 电气间隙<br>Clearance Distance            | L            | > 5.0       | mm         | 从输入端到输出端，通过空气的最短距离<br>Measured from input terminals to output terminals, shortest distance through air     |
| 绝缘距离<br>Insulation Thickness          | DTI          | > 0.4       | mm         | 发射器和探测器之间的绝缘厚度<br>Insulation thickness between emitter and detector  |
| 峰值隔离电压<br>Peak Isolation Voltage      | $V_{IORM}$   | 600         | $V_{peak}$ | DIN/EN/IEC EN60747-5-5   |
| 瞬态隔离电压<br>Transient isolation voltage | $V_{IOTM}$   | 5000        | $V_{peak}$ | DIN/EN/IEC EN60747-5-5   |
| 隔离电压<br>Isolation Voltage             | $V_{iso}$    | > 3750      | $V_{rms}$  | For 1 min  |

**极限参数 Absolute Maximum Ratings (Ta = 25°C)**

| 参数<br>Parameter                |  | 符号<br>Symbol | 额定值<br>Rating | 单位<br>Unit |
|--------------------------------|--|--------------|---------------|------------|
| 发射端<br>Input                   | 正向电流<br>Forward Current  | $I_F$        | 50            | mA         |
|                                | 峰值正向电流(1us, 脉冲)<br>Peak forward current (1us, pulse)                           | $I_{FP}$     | 1000          | mA         |
|                                | 反向电压<br>Reverse Voltage  | $V_R$        | 6             | V          |
|                                | 功耗<br>Power Dissipation  | $P_D$        | 70            | mW         |
|                                | 额定值降低因子(在 Ta = 90°C 以上)<br>Power dissipation Derating factor (above Ta = 90°C) | $P_{DD}$     | 2.0           | mW/°C      |
| 接收端<br>output                  | 集电极功耗<br>Collector Power Dissipation   | $P_C$        | 150           | mW         |
|                                | 集电极电流<br>Collector Current   | $I_C$        | 50            | mA         |
|                                | 集电极-发射极电压<br>Collector-Emitter Voltage   | $V_{CEO}$    | 80            | V          |
|                                | 发射极-集电极电压<br>Emitter-Collector Voltage   | $V_{ECO}$    | 7             | V          |
| 总功耗<br>Total Power Dissipation | $P_{tot}$  | 200          | mW            |            |
| 隔离电压<br>Isolation Voltage      | $V_{iso}$  | 3750         | $V_{rms}$     |            |
| 工作温度<br>Operating Temperature  | $T_{opr}$  | -55 ~ +110   | °C            |            |
| 存储温度<br>Storage Temperature    | $T_{stg}$  | -55 ~ +125   | °C            |            |
| 焊接温度<br>Soldering Temperature  | $T_{sol}$  | 260          | °C            |            |

**产品特性参数 Electro-optical Characteristics (Ta = 25°C)**

| 参数<br>Parameter                     |   | 符号<br>Symbol  | 条件<br>Condition  | 最小<br>Min.         | 典型<br>Typ.         | 最大<br>Max.    | 单位<br>Unit    |
|-------------------------------------|---|---------------|--|--------------------|--------------------|---------------|---------------|
| 发射端<br>Input                        | 正向电压<br>Forward Voltage                             | $V_F$         | $I_F = 20\text{mA}$  | -                  | 1.2                | 1.4           | V             |
|                                     | 反向电流<br>Reverse Current                             | $I_R$         | $V_R = 4\text{V}$  | -                  | -                  | 10            | $\mu\text{A}$ |
|                                     | 输入电容<br>Terminal Capacitance                        | $C_t$         | $V=0, F=1\text{KHz}$   | -                  | 30                 | 250           | pF            |
| 接收端<br>Output                       | 集电极暗电流<br>Collector Dark Current                    | $I_{CEO}$     | $V_{CE}=20\text{V}, I_F=0$                                   | -                  | -                  | 100           | nA            |
|                                     | 集电极-发射极击穿电压<br>Collector-Emitter Breakdown Voltage  | $BV_{CEO}$    | $I_C=0.1\text{mA}, I_F=0$                                    | 80                 | -                  | -             | V             |
|                                     | 发射极-集电极电压<br>Emitter-Collector Voltage              | $BV_{ECO}$    | $I_E=0.01\text{mA}, I_F=0$                                   | 7                  | -                  | -             | V             |
| 传输特性<br>Transfer<br>Characteristics | 电流传输比<br>Current Transfer Ratio                     | CTR*          | $I_F = 5\text{mA}, V_{CE} = 5\text{V}$                       | 80                 | -                  | 600           | %             |
|                                     | 集电极-发射极饱和压降<br>Collector-Emitter Saturation Voltage | $V_{CE(sat)}$ | $I_F = 10\text{mA}, I_C = 1\text{mA}$                        | -                  | 0.1                | 0.2           | V             |
|                                     | 隔离电阻<br>Isolation Resistance                        | $R_{ISO}$     | $V_{I-O} = \text{DC}500\text{V}$<br>40 ~ 60%R.H.             | $5 \times 10^{10}$ | $1 \times 10^{11}$ | -             | $\Omega$      |
|                                     | 隔离电容<br>Isolation capacitance                       | $C_{ISO}$     | $V=0, F=1\text{MHz}$   | -                  | 0.3                | 1.0           | pF            |
|                                     | 上升时间<br>Rise Time                                   | $T_r$         | $V_{CE} = 2\text{V}, I_C = 2\text{mA},$<br>$R_L = 100\Omega$ | -                  | 3                  | 18            | $\mu\text{s}$ |
|                                     | 下降时间<br>Fall Time                                   | $T_f$         |  | -                  | 2                  | 18            | $\mu\text{s}$ |
|                                     | 导通时间<br>Turn on time                                | $T_{on}$      |  | -                  | 5                  | -             | $\mu\text{s}$ |
| 关断时间<br>Turn off time               | $T_{off}$   | -             |  | 3                  | -                  | $\mu\text{s}$ |               |

 注\*：电流传输比= $I_C/I_F \times 100\%$ 。

 Note\*：CTR= $I_C/I_F \times 100\%$ 。

**电流传输比分档表 CTR Classification Table ( $I_F = 5\text{mA}, V_{CE} = 5\text{V}, T_a = 25^\circ\text{C}$ )**

| 代码 Code | 最小值 Min. | 最大值 Max. |
|---------|----------|----------|
| None    | 80       | 600      |
| A       | 80       | 160      |
| B       | 130      | 260      |
| C       | 200      | 400      |
| D       | 300      | 600      |

**典型光电特性曲线 Typical Electro-Optical Characteristics Curves**

Fig.1 Relative Current Transfer Ratio vs. Forward Current

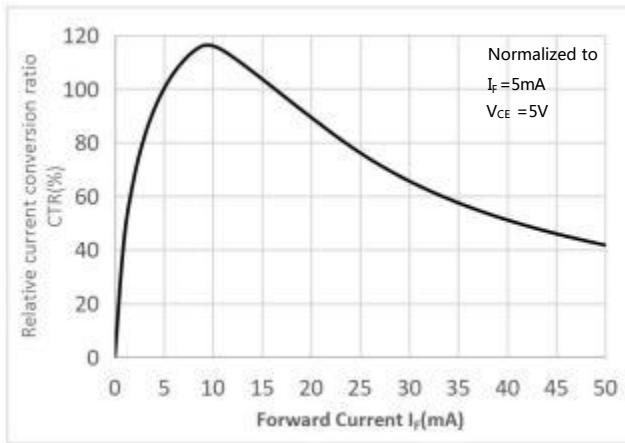

Fig.2 Forward Current vs. Forward Voltage

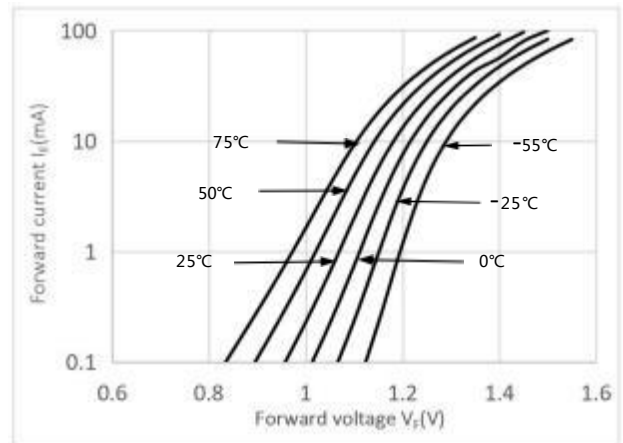

Fig.3 Collector Current vs. Collector-emitter Voltage

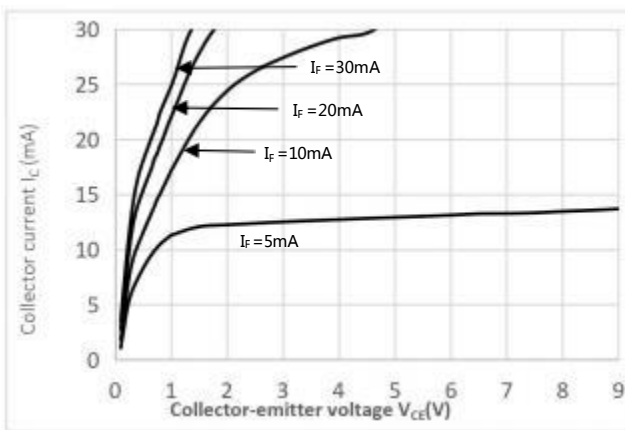

Fig.4 Relative Current Transfer Ratio vs. Ambient Temperature

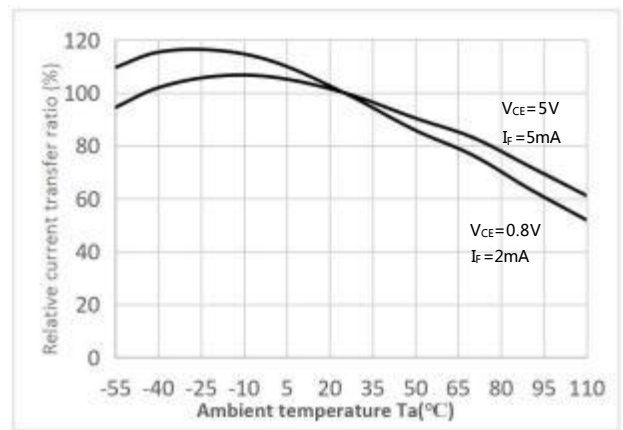

Fig.5 Collector-emitter Saturation Voltage vs. Ambient Temperature

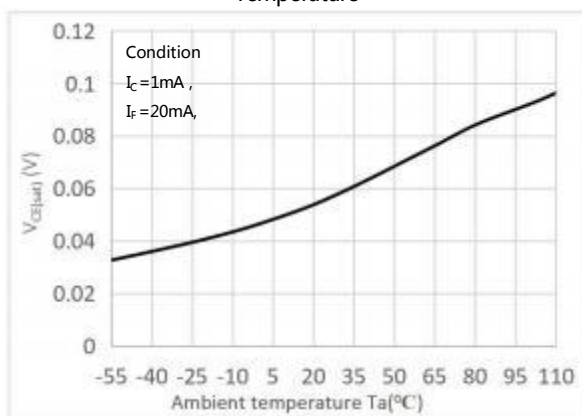

Fig.6 Collector Dark Current vs Ambient Temperature

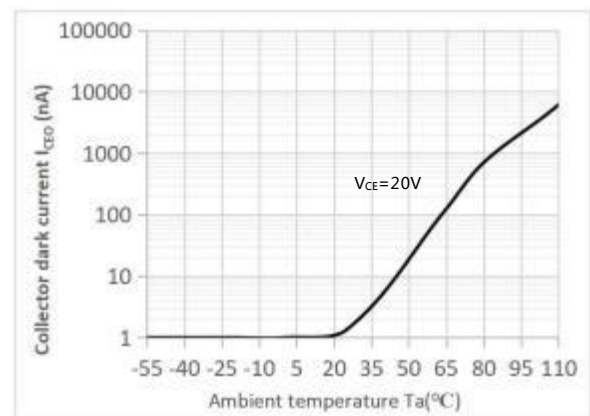

Fig.7 Response Time vs. Load Resistance

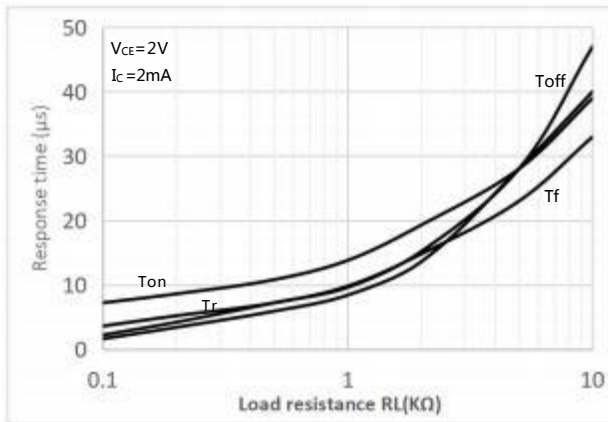

Fig.8 Frequency Response

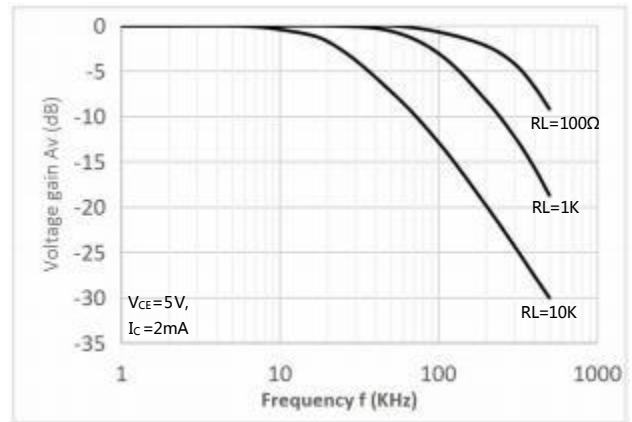

Fig.9 Collector-emitter Saturation Voltage vs Forward Current

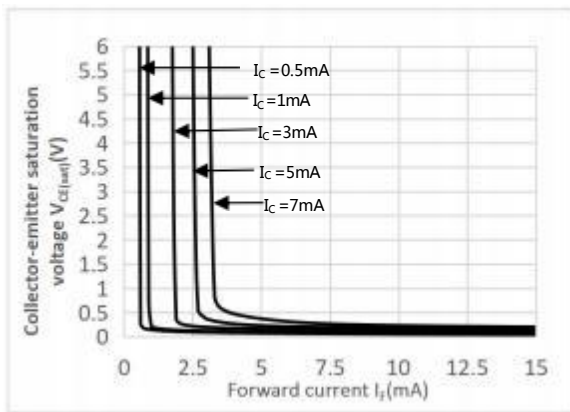
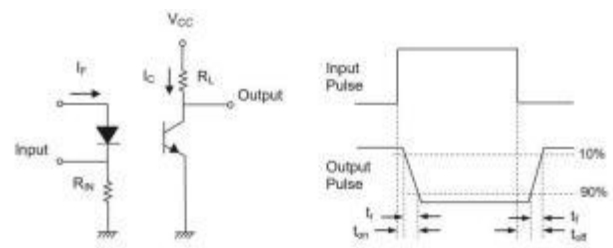
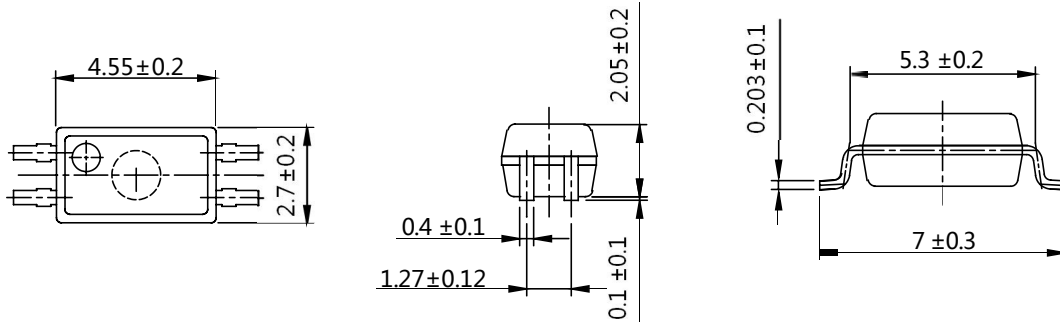

Fig.10 Switching Time Test Circuit & Waveforms



**外形尺寸 Outline Dimensions**

**SSOP4**



单位 Unit: mm

**建议焊盘布局 Recommended Pad Layout**

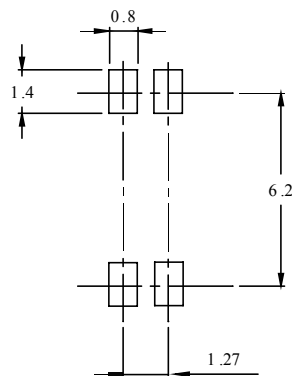

单位 Unit: mm

注：上图为产品正视图。

Note: The picture above is the front view of the product.

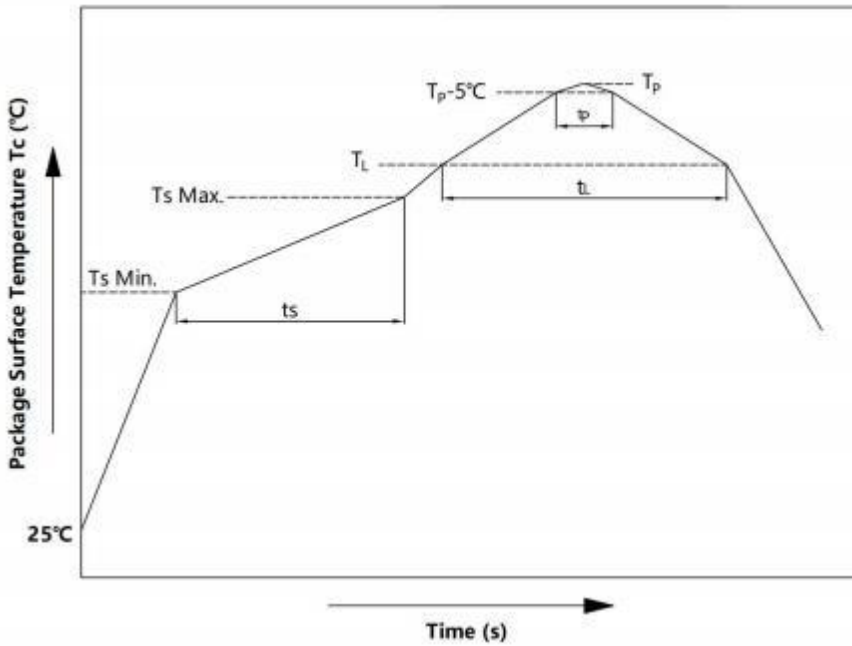

**回流焊温度曲线图 Solder Reflow Profile**

| 项目<br>Item  | 符号<br>Symbol   | 最小值<br>Min. | 最大值<br>Max. | 单位<br>Unit |
|---|----------------|-------------|-------------|------------|
| 预热温度<br>Preheat Temperature   | Ts             | 150         | 200         | °C         |
| 预热时间<br>Preheat Time  | ts             | 60          | 120         | s          |
| 升温速率<br>Ramp-Up Rate (T <sub>L</sub> to T <sub>P</sub> )  | -              | -           | 3           | °C/s       |
| 液相线温度<br>Liquidus Temperature   | T <sub>L</sub> | 217         |             | °C         |
| 时间高于 T <sub>L</sub><br>Time Above T <sub>L</sub>  | t <sub>L</sub> | 60          | 150         | s          |
| 峰值温度<br>Peak Temperature  | T <sub>P</sub> | -           | 260         | °C         |
| Tc 在(T <sub>P</sub> -5)和 T <sub>P</sub> 之间的时间<br>Time During Which Tc Is Between (T <sub>P</sub> -5) and T <sub>P</sub> | t <sub>p</sub> | -           | 30          | s          |
| 降温速率<br>Ramp-down Rate(T <sub>P</sub> to T <sub>L</sub> )   | -              | -           | 6           | °C/s       |

注 Note :

建议在所示的温度和时间条件下进行回流焊，最多不能超过三次；

Reflow soldering is recommended at the temperatures and times shown, no more than three times;

## 波峰焊温度曲线图 Wave Soldering Profile

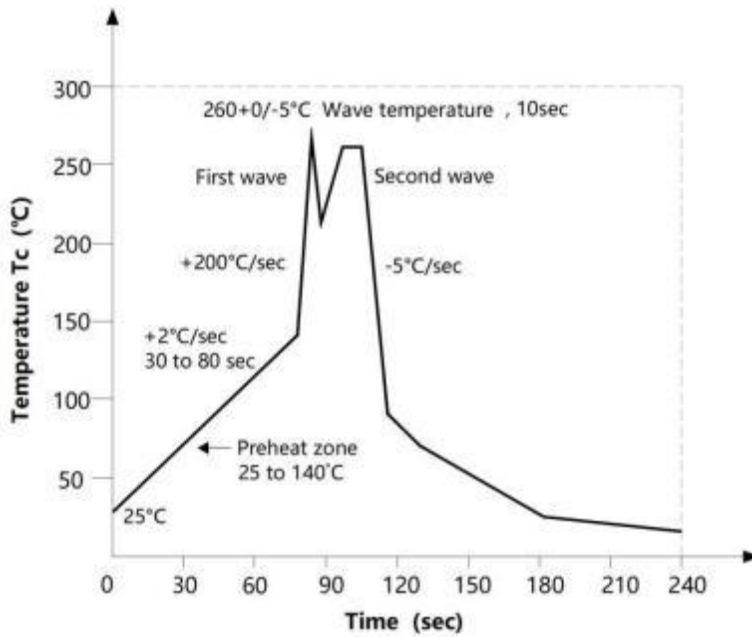

## 手工烙铁焊接 Soldering with hand soldering iron

- A. 手工烙铁焊仅用于产品返修或样品测试；  
Hand soldering iron is only used for product rework or sample testing;
- B. 手工烙铁焊要求：温度  $360^{\circ}\text{C} \pm 5^{\circ}\text{C}$ ，时间  $\leq 3\text{s}$ 。  
Hand soldering iron requirements：Temperature：  $360^{\circ}\text{C} \pm 5^{\circ}\text{C}$ , within 3s.

## 包装 Packing

### ■ 汇总表 Summary table

| 封装形式         | 包装方式                                | 盘数量               | 盒数量              | 箱数量                 | 静电袋规格                        | 盒规格               | 箱(双瓦楞)规格             | 备注   |
|--------------|-------------------------------------|-------------------|------------------|---------------------|------------------------------|-------------------|----------------------|--|
| Package Type | Packing Form                        | Quantity per Reel | Quantity per Box | Quantity per Carton | Antistatic Bag Specification | Box Specification | Carton Specification | Note   |
| SSOP4        | 卷盘<br>( $\phi 330\text{mm}$ 蓝盘)     | 3000 只/盘          | 2 盘/盒            | 10 盒/箱              | 450*390*0.1mm                | 34*6*34cm         | 38*36*36.5cm         | 首端各空 50 个空格, 末端空 100                                       |
| SSOP4        | Reel<br>( $\phi 330\text{mm}$ Blue) | 3000 pcs<br>/reel | 2 reels<br>/box  | 10 boxes<br>/ctn    | 450*390*0.1mm                | 34*6*34cm         | 38*36*36.5cm         | Leave 50 Spaces at the beginning and 100 Spaces at the end |

### ■ 编带包装 Tape & Reel

- 1) 每卷数量：3000 只。  
Qty/reel：3000 pcs.
- 2) 每箱数量：60000 只。  
Qty/ctn：60000 pcs.
- 3) 内包装：每盒 2 盘。  
Inner packing：2 reels/box.
- 4) 示意图 Schematic：

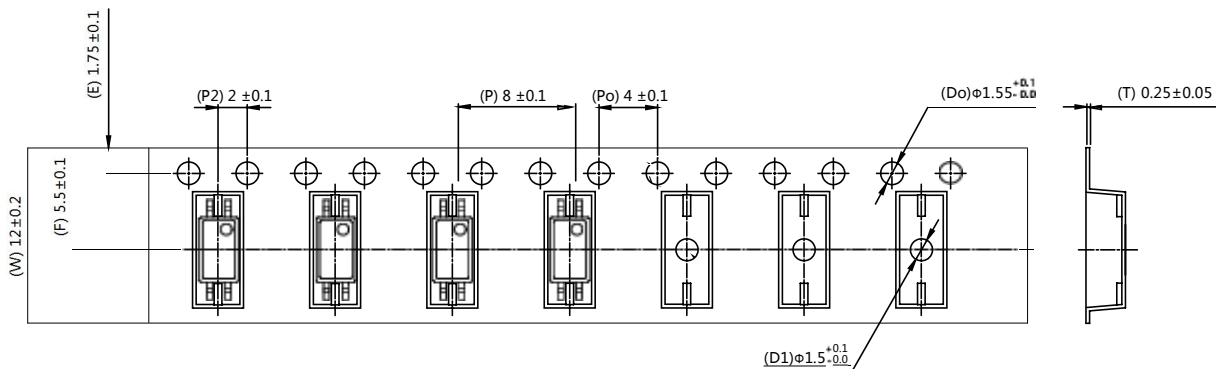

单位 Unit：mm

## 注意 Attention

- 奥特持续不断改进质量、可靠性、功能或设计，保留此文件更改的权利恕不另行通知。  
AOTE continuously improve quality, reliability, function and design. We reserve the right to change this document without prior notice.
- 请遵守产品规格书使用，奥特不对使用时不符合产品规格书条件而导致的质量问题负责。  
Please use in accordance with the product specification. AOTE is not responsible for the quality problems caused by non-compliance with the product specifications.
- 对于需要高可靠性或安全性的设备/装置需求，请联系我们的销售人员。  
For equipment/devices requiring high reliability or safety, please contact our sales representatives.
- 当需要用于任何“特定”应用时，请咨询我们的销售人员。  
When requiring a device for any “specific” application, please contact our sales in advice.
- 如对文件中表述的内容有疑问，欢迎联系我们。  
If you have any questions about the contents of the document, please contact us.

单击下面可查看定价，库存，交付和生命周期等信息

[>>AOTE\(奥特\)](#)