



高速光耦
High Speed Photo
Coupler

6N137M

Product Data Sheet

AOTE DCC
RELEASE

台湾奥特半导体科技有限公司

TAIWAN AOTE SEMICONDUCTOR TECHNOLOGY CO.,LTD

www.aotesemi.com

概述 Description

6N137M 光耦合器由一个 850nm 的 AlGaAs LED 组成，其光学耦合到一个非常高速的集成光电探测器逻辑门，可快速输出。

The 6N137M optocoupler consists of a 850 nm AlGaAs LED, optically coupled to a very high speed integrated photo-detector logic gate with a strobeable output.

特性 Features

- 高比特率：10MBit/s
High bit rate：10MBit/s
- 输入-输出隔离电压 ($V_{ISO}=5000\text{ Vrms}$)
High isolation voltage between input and output ($V_{ISO}=5000\text{ Vrms}$)
- 工作温度范围：-40°C ~ 85°C
Fan-out of 8 over -40°C to +85°C
- 逻辑门输出
Logic gate output
- 频闪输出
Strobeable output
- 符合加强绝缘标准
Meet reinforced insulation standards
- 符合安规标准：UL 1577，VDE DIN EN60747-5-5 (VDE 0884-5)，CQC11-471543-2022
Meet Safety standard: UL 1577, VDE DIN EN60747-5-5 (VDE 0884-5)，CQC11-471543-2022

应用 Applications

- 接地回路消除
Ground loop elimination
- LSTTL 转 TTL, LSTTL 或 5V CMOS
LSTTL to TTL, LSTTL or 5-volt CMOS
- 线路接收器，数据传输
Line receiver, data transmission
- 开关电源
Switching power supplies
- 计算机外围接口
Computer-peripheral interface

真值表 Truth table

LED	ENABLE	OUT
ON	H	L
OFF	H	H
ON	L	H
OFF	L	H
ON	NC	L
OFF	NC	H

封装和原理图 Package and Schematic Diagram

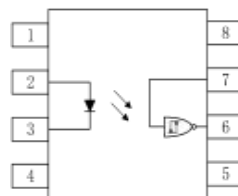



Pin Configuration

1. NC	8. VCC
2. Anode	7. VE
3. Cathode	6. VO
4. NC	5. GND

注：在引脚 5 和 8 之间必须连接一个 0.1uF 的旁路电容器。

Note: 0.1uF bypass capacitor must be connected between pins 5 and 8.

印字信息 Marking Information

- 印字中 “” 为奥特品牌 LOGO
 “” denotes LOGO
- 印字中 “Y” 代表年份: A(2018), B(2019), C(2020).....
 “Y” denotes YEAR : A(2018), B(2019), C(2020).....
- 印字中 “WW” 代表周号
 “WW” denotes Week' s number
- 印字中 “N” 代表星期几
 “N” denotes the day of the week
- 印字中的 “H” 代表无卤
 “H” denotes Halogen-free

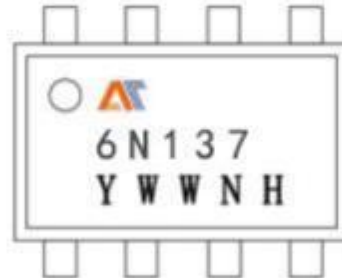

绝缘和安规信息 Insulation and Safety related specifications

项目 Item	符号 Symbol	数值 Value	单位 Unit	备注 Remark
爬电距离 Creepage Distance	L	>7.6	mm	从输入端到输出端，沿本体最短距离路径 Measured from input terminals to output terminals, shortest distance path along body
电气间隙 Clearance Distance	L	>7.6	mm	从输入端到输出端，通过空气的最短距离 Measured from input terminals to output terminals, shortest distance through air
绝缘距离 Insulation Thickness	DTI	> 0.4	mm	发射器和探测器之间的绝缘厚度 Insulation thickness between emitter and detector
峰值隔离电压 Peak Isolation Voltage	V_{IORM}	1500	V_{peak}	DIN/EN/IEC EN60747-5-5
瞬态隔离电压 Transient isolation voltage	V_{IOTM}	7000	V_{peak}	DIN/EN/IEC EN60747-5-5
隔离电压 Isolation Voltage	V_{iso}	> 5000	V_{rms}	For 1 min

极限参数 Absolute Maximum Ratings (TA = 25°C)

参数 Parameter		符号 Symbol	额定值 Rating	单位 Unit
发射端 Input	正向输入电流 (平均) DC/Average Forward Input Current	I_F	20	mA
	使能输入电压不超过 V_{CC} 500mV Enable Input Voltage Not to Exceed V_{CC} by more than 500mV	V_E	5.5	V
	反向输入电压 Reverse Input Voltage	V_R	5.0	V
	功耗 Power Dissipation	P_t	100	mW
接收端 output	电源电压 Supply Voltage	V_{CC} (1 minute max)	7.0	V
	输出电流 Output Current	I_o	50	mA
	输出电压 Output Voltage	V_o	7.0	V
	输出功率 Collector Output	P_o	85	mW
工作温度 Operating Temperature		T_{opr}	-40~+85	°C
存储温度 Storage Temperature		T_{stg}	-55~+125	°C
焊接温度 Lead Solder Temperature (for wave soldering only)		T_{sol}	260 for 10 sec	°C

推荐操作条件 Recommended Operating Conditions

参数 Parameter	符号 Symbol	最小值 Min	最大值 Max	单位 Unit
低电平输入电流 Low Level Input Current	I_{L}	0	250	μA
高电平输入电流 High Level Input Current	I_{H}	6.3	15	mA
电源电压 Supply Voltage	V_{CC}	2.7	5.5	V
低电平使能电压 Low Level Enable Voltage	V_{EL}	0	0.8	V
高电平使能电压 Low Level Enable Voltage	V_{EH}	2.0	V_{CC}	V
工作温度 Operating Temperature	T_A	-40	+85	$^{\circ}\text{C}$
输出上拉电阻 Output Pull-up Resistor	R_L	330	4k	Ω

产品特性参数 Electro-optical Characteristics (T_A = 25°C)

参数 Parameter		符号 Symbol	条件 Condition	最小 Min.	典型 Typ.	最大 Max.	单位 Unit
发射端 Input	正向电压 Input Forward Voltage	V _F	I _F = 10mA	-	1.33	1.75	V
	反向击穿电压 Input Reverse Breakdown Voltage	B _{VR}	I _R = 10μA	5	20	45	V
	输入电容 Input Capacitance	C _{IN}	V = 0, f = 1MHz	-	70	-	pF
接收端 Output	正向电压的温度系数 Input Diode Temperature Coefficient	ΔV _F /ΔT _A	I _F = 10mA	-	-1.4	-	mV/°C
	高电平电源电流 High Level Supply Current	I _{CCH}	V _{CC} = 5.5V, I _F = 0mA, V _E = 0.5V	-	6.5	10	mA
	低电平电源电流 Low Level Supply Current	I _{CCL}	V _{CC} = 5.5V, I _F = 10mA	-	9	13	mA
传输特性 Transfer Characteristics	低电平使能电流 Low Level Enable Current	I _{EL}	V _{CC} = 5.5V, V _E = 0.5V	-	-0.8	-1.6	mA
	高电平使能电流 High Level Enable Current	I _{EH}	V _{CC} = 5.5V, V _E = 2.0V	-	-0.6	-1.6	mA
	高电平使能电压 High Level Enable Voltage	V _{EH}	V _{CC} = 5.5V, I _F = 10mA	2.0	-	-	V
	低电平使能电压 Low Level Enable Voltage	V _{EL}	V _{CC} = 5.5V, I _F = 10mA	-	-	0.8	V
	高电平输出电流 High Level Output Current	I _{OH}	V _{CC} = 5.5V, V _O = 5.5V I _F = 250μA, V _E = 2V	-	-	100	μA
	低电平输出电压 Low Level Output Current	V _{OL}	V _{CC} = 5.5V, I _F = 5mA I _{OL} = 13mA, V _E = 2V	-	0.35	0.6	V
	输入阈值电流 Input Threshold Current	I _{FT}	V _{CC} = 5.5V, V _O < 0.6V I _{OL} = 13mA, V _E = 2V	-	3	5	mA
隔离电阻 Isolation Resistance	R _{I-O}	V _{I-O} = 500V	-	10 ¹²	-	Ω	
隔离电容 Isolation Capacitance	C _{I-O}	f = 1MHz	-	0.6	-	pF	

开关特性 Switching Specification

参数 Parameter	符号 Symbol	条件 Condition	最小 Min.	典型 Typ.	最大 Max.	单位 Unit
输出高电平传播延迟 Propagation Delay Time to Output HIGH Level	T_{PLH}	$I_f = 7.5mA,$ $V_{CC} = 5V,$ $R_L = 350\Omega,$ $C_L = 15pF$	20	41	100	ns
输出低电平传播延迟 Propagation Delay Time to Output LOW Level	T_{PHL}		25	50	100	ns
脉宽失真 ($ T_{PHL}-T_{PLH} $) Pulse Width Distortion	PWD		-	5	35	ns
输出上升时间(10% – 90%) Output Rise Time (10–90%)	tr		-	30	-	ns
输出下降时间(90% - 10%) Output Rise Time (90–10%)	tf		-	10	-	ns
输出高电平使能传播延迟 Enable Propagation Delay Time to Output HIGH Level	t_{ELH}	$I_f = 7.5mA,$ $V_{EH} = 3.5V,$ $R_L = 350\Omega,$ $C_L = 15pF$	-	15	-	ns
输出低电平使能传播延迟 Enable Propagation Delay Time to Output LOW Level	t_{EHL}		-	40	-	ns
输出高电平共模瞬态抑制 Common Mode Transient Immunity (at Output HIGH Level)	$ CM_H $	$T_A = 25^\circ C$ $V_{CC} = 5V, I_f = 0mA$ $ V_{CM} = 50V(\text{Peak})$ $V_{O(\text{MIN})} = 2.0V, R_L = 350\Omega$	5000	10000	-	V/ μs
输出低电平共模瞬态抑制 Common Mode Transient Immunity (at Output LOW Level)	$ CM_L $	$T_A = 25^\circ C$ $V_{CC} = 5V, I_f = 10mA$ $ V_{CM} = 50V(\text{Peak})$ $V_{O(\text{MAX})} = 2.0V, R_L = 350\Omega$	5000	10000	-	V/ μs

典型光电特性曲线 Typical Electro-Optical Characteristics Curves

Fig.1 Low-level output voltage vs. Ambient temperature

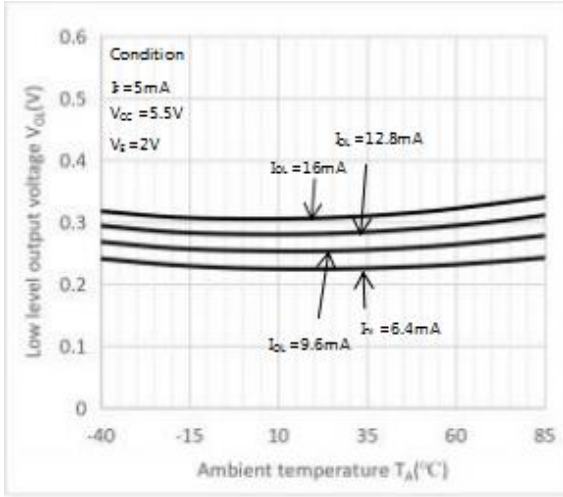

Fig.2 Forward current vs. Forward voltage

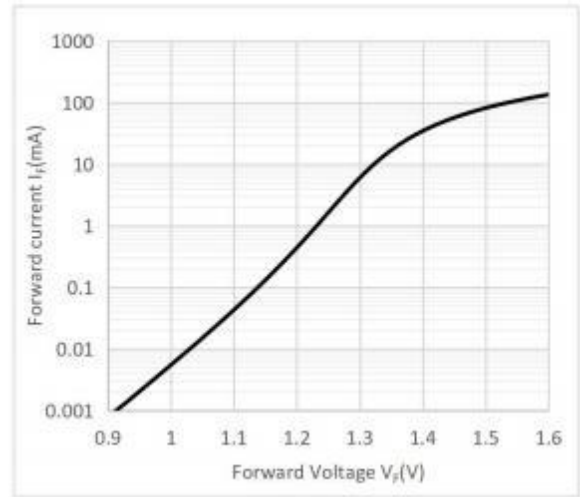

Fig.3 Propagation delay time vs. Forward current

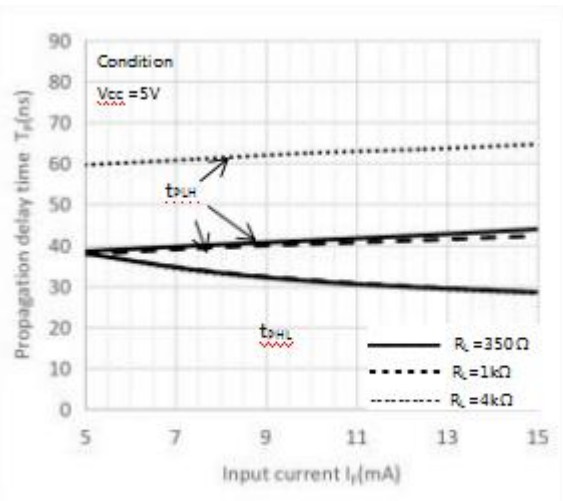

Fig.4 Low-level output current vs. Ambient temperature

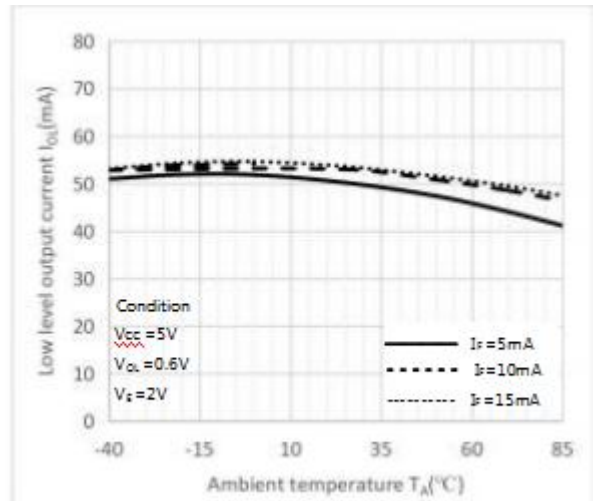

Fig.5 Input threshold current vs. Ambient temperature

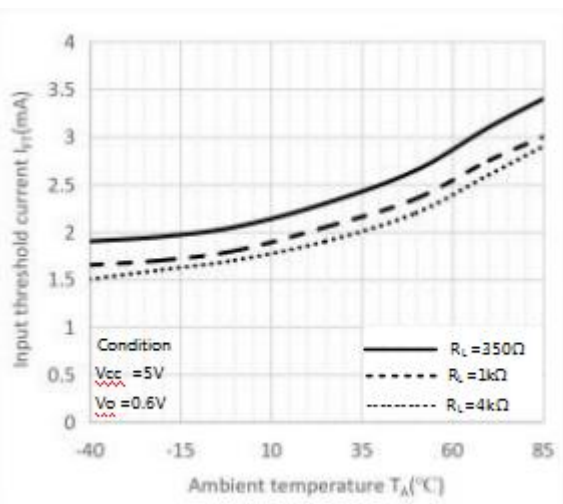

Fig.6 Output voltage vs. Forward current

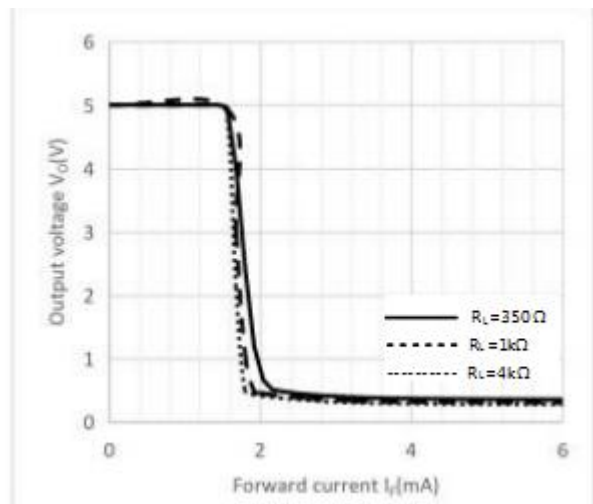

Fig.7 Pulse-width distortion vs. Ambient temperature

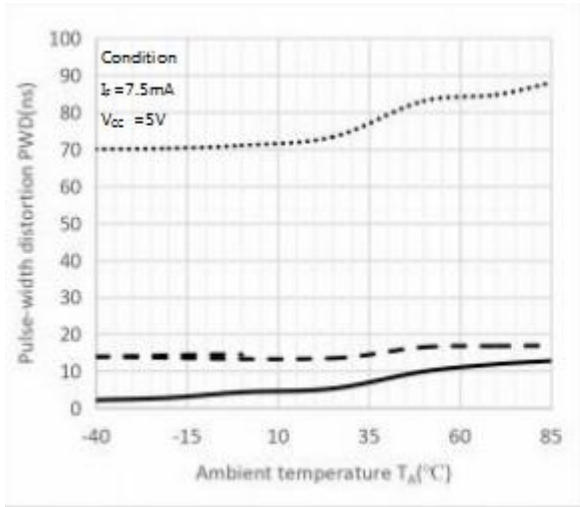

Fig.8 Switching time vs. Ambient temperature

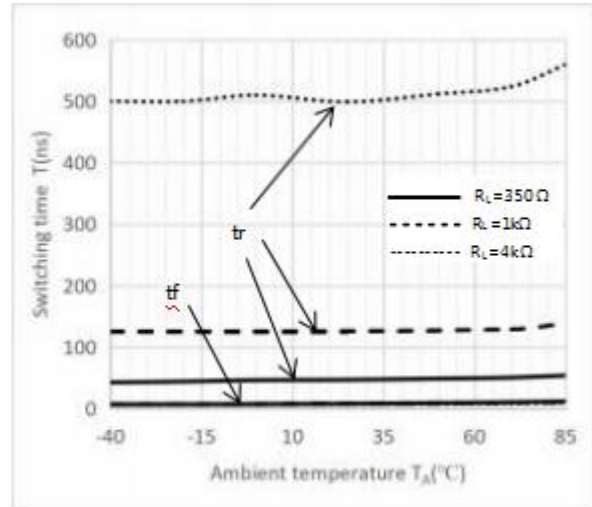

Fig.9 Propagation delay time vs. Ambient temperature

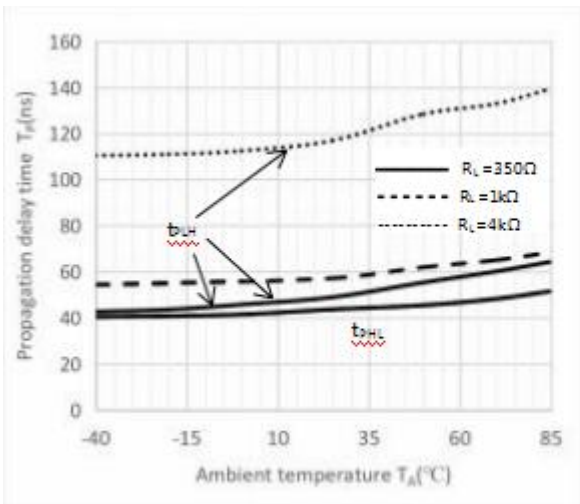

Fig.10 Propagation delay time vs. Ambient temperature

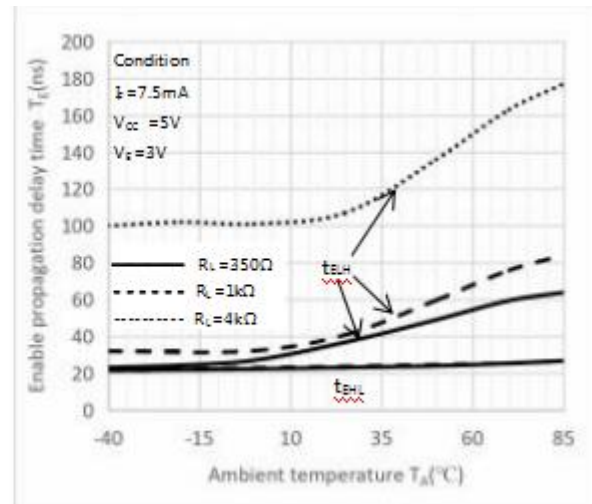
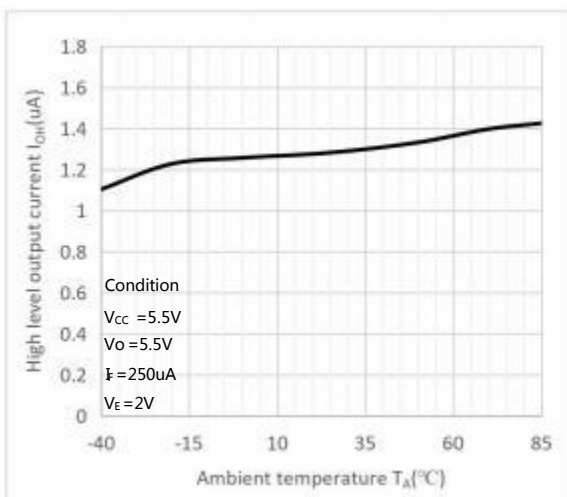
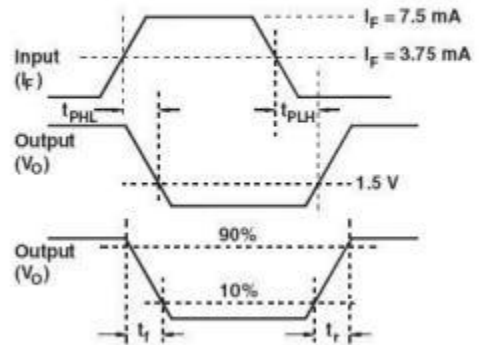
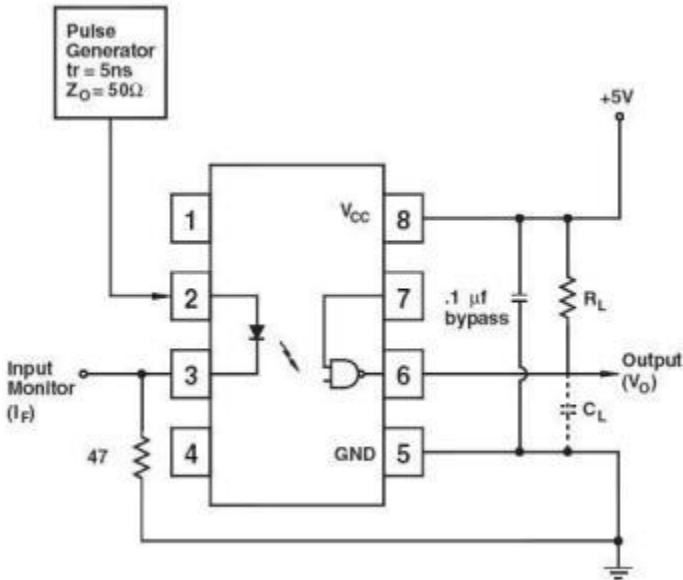
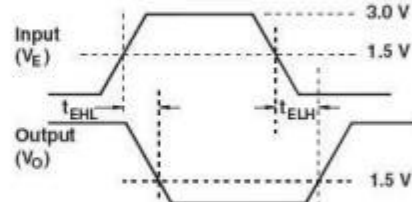
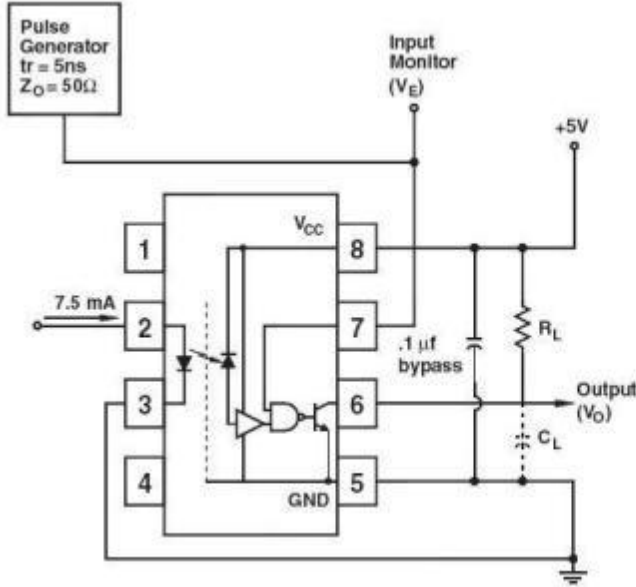

Fig.11 High-level output current vs. Ambient temperature



传输延迟时间测试电路 Test Circuit for Propagation Delay Time



CMR 测试电路 Test Circuit for Common Mode Transient Immunity

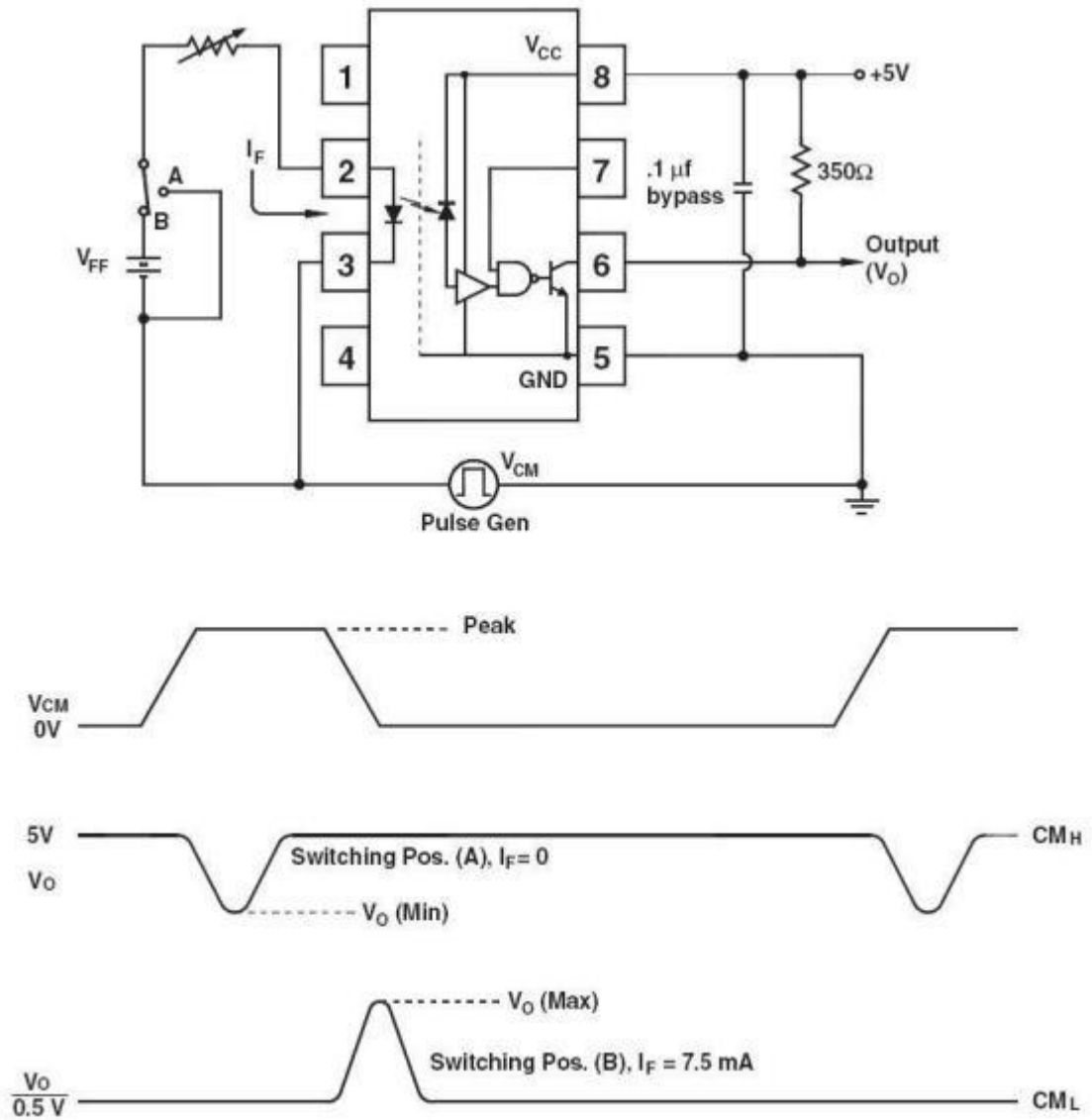

外形尺寸 Outline Dimensions

DIP8

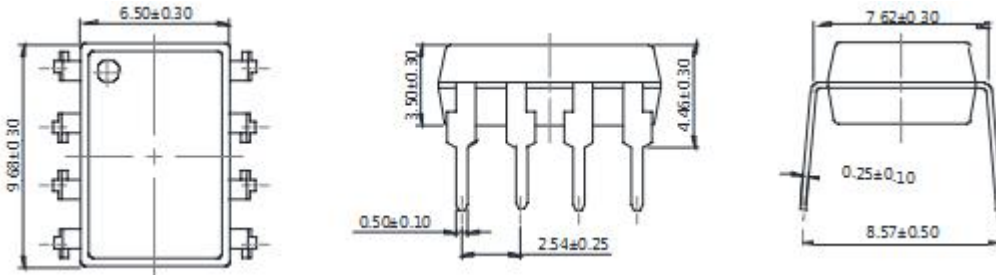

SMD8

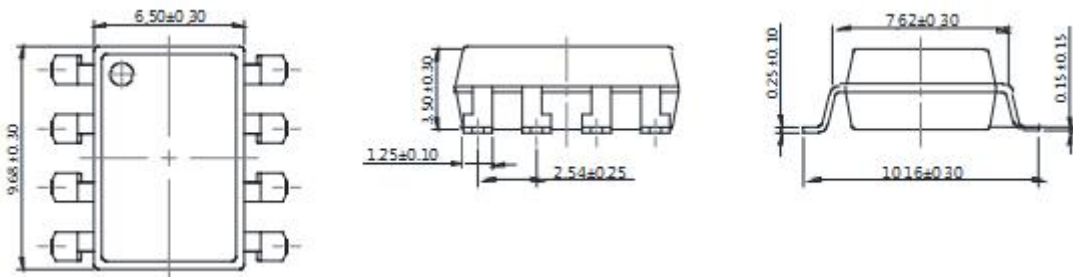

单位 Unit: mm

建议焊盘布局 Recommended Pad Layout

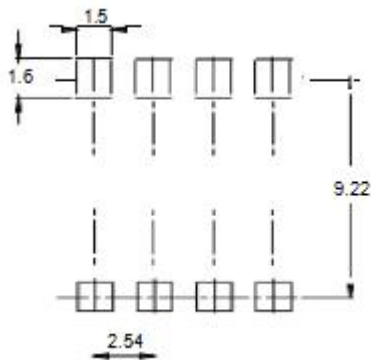

单位 Unit: mm

注：上图为产品正视图。

Note : The picture above is the front view of the product

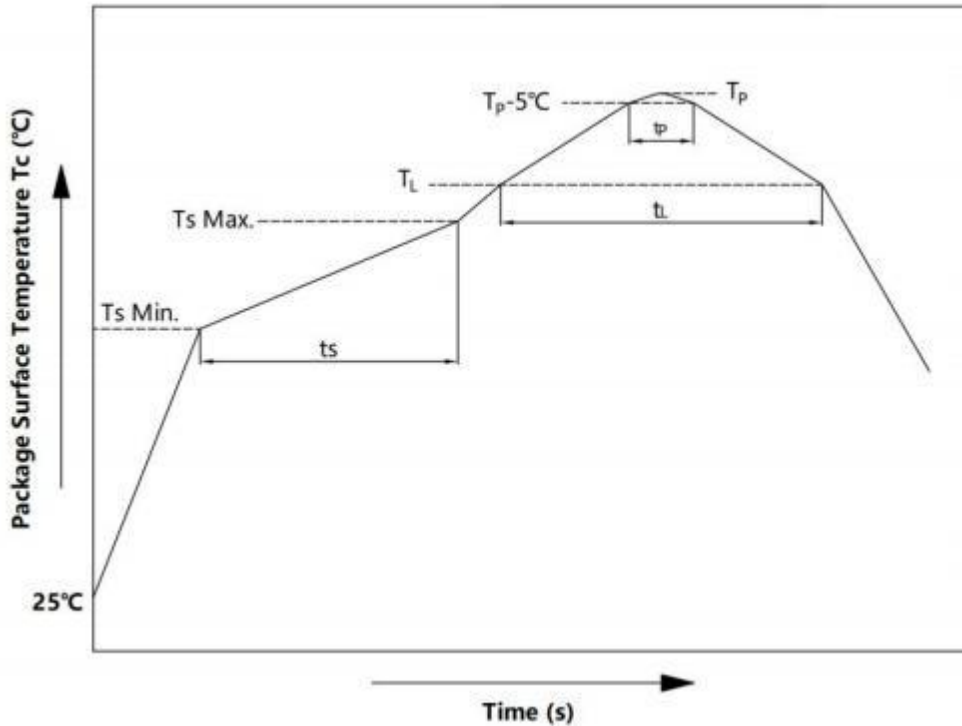
回流焊温度曲线图 Solder Reflow Profile

项目 Item	符号 Symbol	最小值 Min.	最大值 Max.	单位 Unit
预热温度 Preheat Temperature	T_s	150	200	$^\circ\text{C}$
预热时间 Preheat Time	t_s	60	120	s
升温速率 Ramp-Up Rate (T_L to T_p)	-	-	3	$^\circ\text{C}/\text{s}$
液相线温度 Liquidus Temperature	T_L	217		$^\circ\text{C}$
时间高于 T_L Time Above T_L	t_L	60	150	s
峰值温度 Peak Temperature	T_p	-	260	$^\circ\text{C}$
T_c 在 (T_p-5) 和 T_p 之间的时间 Time During Which T_c Is Between (T_p-5) and T_p	t_p	-	30	s
降温速率 Ramp-down Rate (T_p to T_L)	-	-	6	$^\circ\text{C}/\text{s}$

注：建议在所示的温度和时间条件下进行回流焊，最多不能超过三次。

Note: Reflow soldering is recommended at the temperatures and times shown, no more than three times.

波峰焊温度曲线图 Wave Soldering Profile

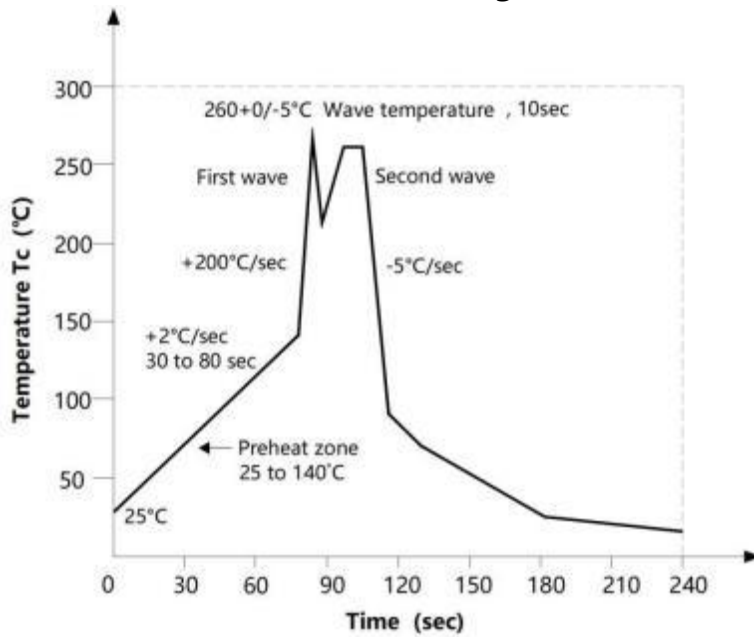

手工烙铁焊接 Soldering with hand soldering iron

- A. 手工烙铁焊仅用于产品返修或样品测试；
Hand soldering iron is only used for product rework or sample testing;
- B. 手工烙铁焊要求：温度 $360^{\circ}\text{C} \pm 5^{\circ}\text{C}$ ，时间 $\leq 3\text{s}$ 。
Manual soldering method Temperature: $360^{\circ}\text{C} \pm 5^{\circ}\text{C}$, within 3s.

包装 Packing

■ 汇总表 Summary table

封装形式	包装方式	盘数量	盒数量	箱数量	静电袋规格	盒规格	箱(双瓦楞)规格	备注
SMD8	卷盘 ($\phi 330$ mm 蓝盘)	1千只/盘	2盘/盒	10盒/箱	450*390*0.1mm	340*60*340mm	380*360*365mm	首端空 50 个空格，末端空 100
DIP8	管装 (500*12*11mm)	45只/管	50管/盒	10盒/箱	不适用	525*128*56mm	535*275*300mm	每管使用蓝白胶塞，方向须一致
Package Type	Packing Form	Quantity per Reel	Quantity per Box	Quantity per Carton	Antistatic Bag Specification	Box Specification	Carton Specification	Note
SMD8	Reel($\phi 330$ mm Blue)	1k pcs/reel	2 reels /box	10 boxes /ctn	450*390*0.1mm	340*60*340mm	380*360*365mm	Leave 50 spaces at the beginning and 100 spaces at the end
DIP8	Tube (500*12*11mm)	45pcs /tube	50 tubes/box	10boxes/ctn	NA	525*128*56mm	535*275*300mm	Endplug (blue) and Endplug (white) keep the direction

■ 编带包装 Tape & Reel

- 1) 每箱数量：22500 只。
Qty/ctn：22500pcs
- 2) 内包装：Inner packing：
 - i. 每条管 45 只。
45pcs/tube
 - ii. 每盒 50 条管。
50 tubes/box
- 3) 示意图 Schematic：

■ 编带包装 Tape & Reel

- 1) 每卷数量：1000 只。
Qty/reel：1000 pcs.
- 2) 每箱数量：20000 只。
Qty/ctn：20000 pcs.
- 3) 内包装：每盒 2 盘。
Inner packing：2 reels/box.
- 4) 示意图 Schematic：

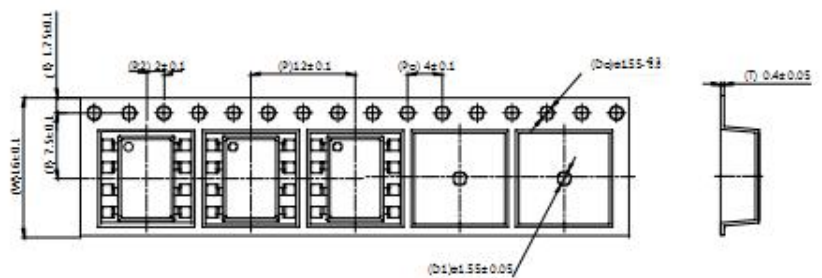
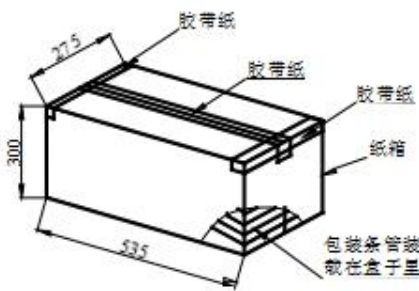

单位 Unit：mm

注意 Attention

- 奥特持续不断改进质量、可靠性、功能或设计，保留此文件更改的权利恕不另行通知。
AOTE continuously improve quality, reliability, function or design. We reserve the right to change this document without notice.
- 请遵守产品规格书使用，奥特不对使用时不符合产品规格书条件而导致的质量问题负责。
Please use in accordance with the product specification. AOTE is not responsible for the quality problems caused by non-compliance with the product specifications.
- 对于需要高可靠性或安全性的设备/装置需求，请联系我们的销售人员。
For equipment/devices where high reliability or safety is required, please contact our sales representatives.
- 当需要用于任何“特定”应用时，请咨询我们的销售人员。
When requiring a device for any “specific” application, please contact our sales in advice.
- 如对文件中表述的内容有疑问，欢迎联系我们。
If you have any questions about the contents of the document, please contact us.

单击下面可查看定价，库存，交付和生命周期等信息

[>>AOTE\(奥特\)](#)