

## Depletion-Mode Power MOSFET

### General Features

- Depletion Mode (Normally On)
- Proprietary Advanced Planar Technology
- Rugged Polysilicon Gate Cell Structure
- RoHS Compliant
- Halogen-free Available

$BV_{DSX}$	$R_{DS(ON)}$ (Max.)	$I_D$
550V	70Ω	0.09A

### Applications

- Transient Protect
- Start-up
- Converters
- Normally On Switches
- LED Drive Circuits
- Power Supplies
- Current Source
- Voltage Source

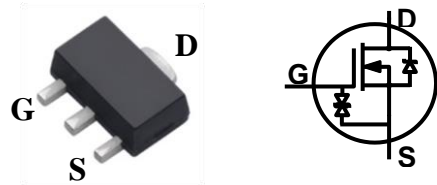
**SOT-89**

### Ordering Information

Part Number	Package	Marking	Remark
DMX5530E	SOT-89	5530	Halogen Free

### Absolute Maximum Ratings

 $T_A=25^{\circ}\text{C}$  unless otherwise specified

Symbol	Parameter	DMX5530E	Unit
$V_{DSX}$	Drain-to-Source Voltage <sup>[1]</sup>	550	V
$V_{DGX}$	Drain-to-Gate Voltage <sup>[1]</sup>	550	V
$I_D$	Continuous Drain Current	0.09	A
$I_{DM}$	Pulsed Drain Current <sup>[2]</sup>	0.36	
$P_D$	Power Dissipation	1	W
$V_{GS}$	Gate-to-Source Voltage	±20	V
$T_L$	Soldering Temperature Distance of 1.6mm from case for 10 seconds	300	°C
$T_J$ and $T_{STG}$	Operating and Storage Temperature Range	-55 to 150	

Caution: Stresses greater than those listed in the "Absolute Maximum Ratings" may cause permanent damage to the device.

### Thermal Characteristics

Symbol	Parameter	DMX5530E	Unit
$R_{\theta JC}$	Thermal Resistance, Junction-to-Case	125	°C/W

## Electrical Characteristics

### OFF Characteristics

 $T_A = 25^\circ\text{C}$  unless otherwise specified

Symbol	Parameter	Min.	Typ.	Max.	Unit	Test Conditions
$BV_{DSX}$	Drain-to-Source Breakdown Voltage	550	--	--	V	$V_{GS} = -10\text{V}$ , $I_D = 250\mu\text{A}$
$I_{D(OFF)}$	Drain-to-Source Leakage Current	--	--	2	$\mu\text{A}$	$V_{DS} = 550\text{V}$ , $V_{GS} = -10\text{V}$
$I_{GSS}$	Gate-to-Source Leakage Current	--	--	10	$\mu\text{A}$	$V_{GS} = +20\text{V}$ , $V_{DS} = 0\text{V}$
		--	--	-10		$V_{GS} = -20\text{V}$ , $V_{DS} = 0\text{V}$

### ON Characteristics

 $T_A = 25^\circ\text{C}$  unless otherwise specified

Symbol	Parameter	Min.	Typ.	Max.	Unit	Test Conditions
$R_{DS(ON)}$	Static Drain-to-Source On-Resistance	--	--	70	$\Omega$	$V_{GS} = 0\text{V}$ , $I_D = 50\text{mA}^{[3]}$
$V_{GS(OFF)}$	Gate-to-Source Cut-off Voltage	-1.5	--	-3.8	V	$V_{DS} = 3\text{V}$ , $I_D = 8\mu\text{A}$
gfs	Forward Transconductance	--	60.3	--	mS	$V_{DS} = 10\text{V}$ , $I_D = 50\text{mA}^{[3]}$

### Dynamic Characteristics

Essentially independent of operating temperature

Symbol	Parameter	Min.	Typ.	Max.	Unit	Test Conditions
$C_{iss}$	Input Capacitance	--	58.5	--	pF	$V_{GS} = -10\text{V}$ $V_{DS} = 25\text{V}$ $f = 1.0\text{MHz}$
$C_{oss}$	Output Capacitance	--	13.8	--		
$C_{rss}$	Reverse Transfer Capacitance	--	3.9	--		
$Q_g$	Total Gate Charge	--	215.4	--	nC	$V_{GS} = -10\text{V} \sim 0\text{V}$ $V_{DD} = 25\text{V}$ $I_D = 50\text{mA}$
$Q_{gs}$	Gate-to-Source Charge	--	35.8	--		
$Q_{gd}$	Gate-to-Drain (Miller) Charge	--	112	--		

### Resistive Switching Characteristics

Essentially independent of operating temperature

Symbol	Parameter	Min.	Typ.	Max.	Unit	Test Conditions
$t_{d(on)}$	Turn-on Delay Time	--	5.9	--	ns	$V_{GS} = -10\text{V} \sim 0\text{V}$ $V_{DD} = 25\text{V}$ $I_D = 50\text{mA}$ $R_G = 10\Omega$
$t_{rise}$	Rise Time	--	8.8	--		
$t_{d(off)}$	Turn-off Delay Time	--	16.5	--		
$t_{fall}$	Fall Time	--	305	--		

### Source-Drain Diode Characteristics

 $T_A = 25^\circ\text{C}$  unless otherwise specified

Symbol	Parameter	Min.	Typ.	Max.	Units	Test Conditions
$V_{SD}$	Diode Forward Voltage	--	0.8	1.5	V	$I_{SD} = 50\text{mA}^{[3]}$ , $V_{GS} = -10\text{V}$

NOTE:

[1]  $T_J = +25^\circ\text{C}$  to  $+150^\circ\text{C}$ 

[2] Repetitive rating, pulse width limited by maximum junction temperature.

[3] Pulse width  $\leq 380\mu\text{s}$ ; duty cycle  $\leq 2\%$ .

## Typical Characteristics

Figure 1. Maximum Power Dissipation vs. Case Temperature

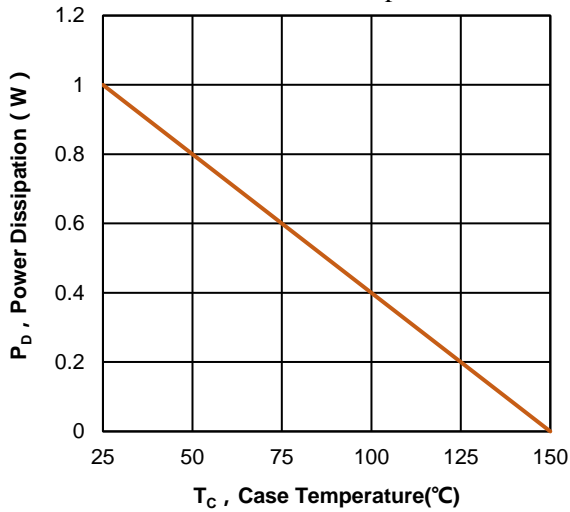

Figure 2. Maximum Continuous Drain Current vs. Case Temperature

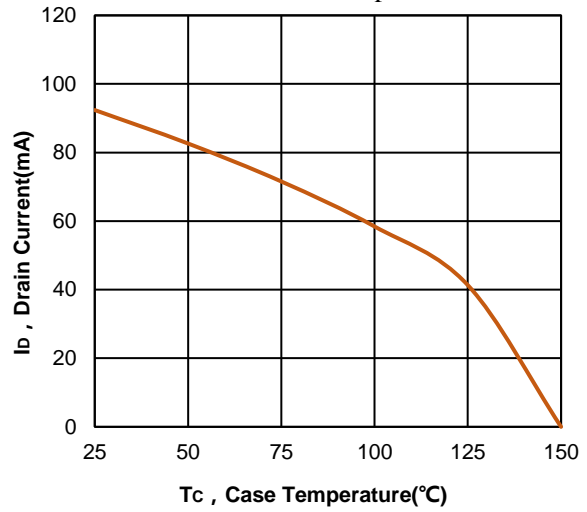

Figure 3. Typical Output Characteristics

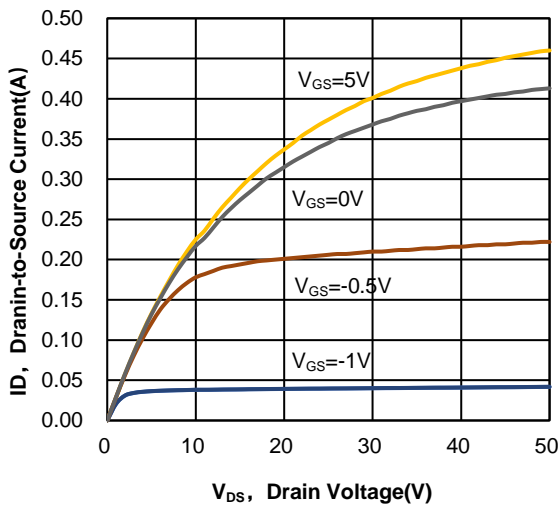

Figure 4. Typical Transfer Characteristics

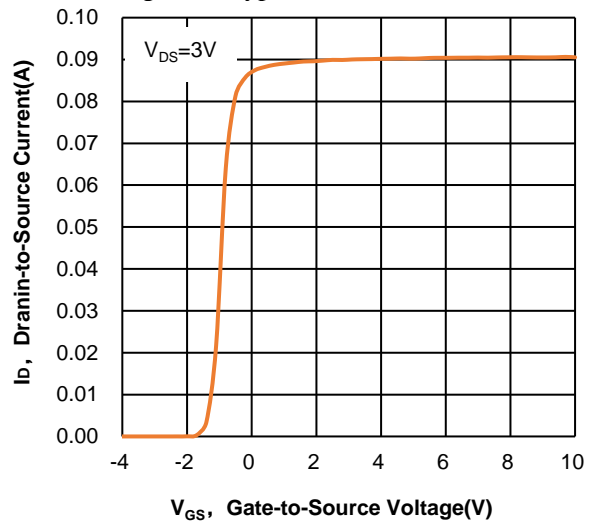

Figure 5. Typical Capacitance vs. Drain-to-Source Voltage

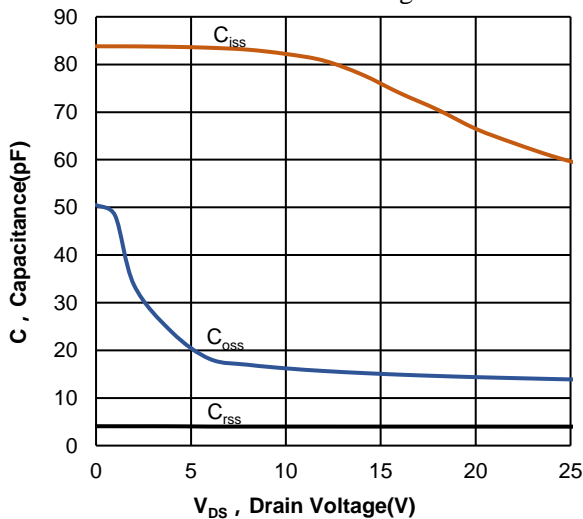
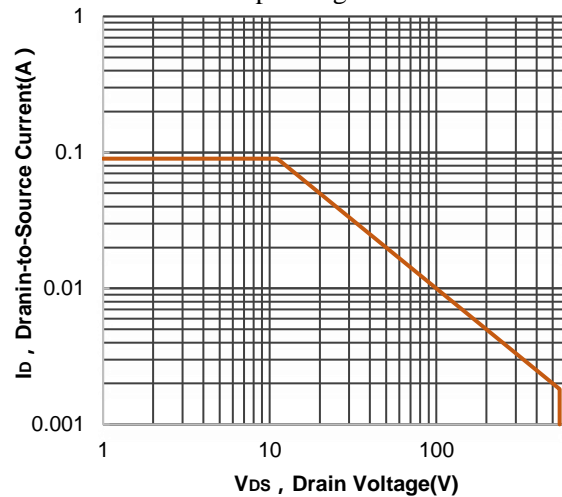
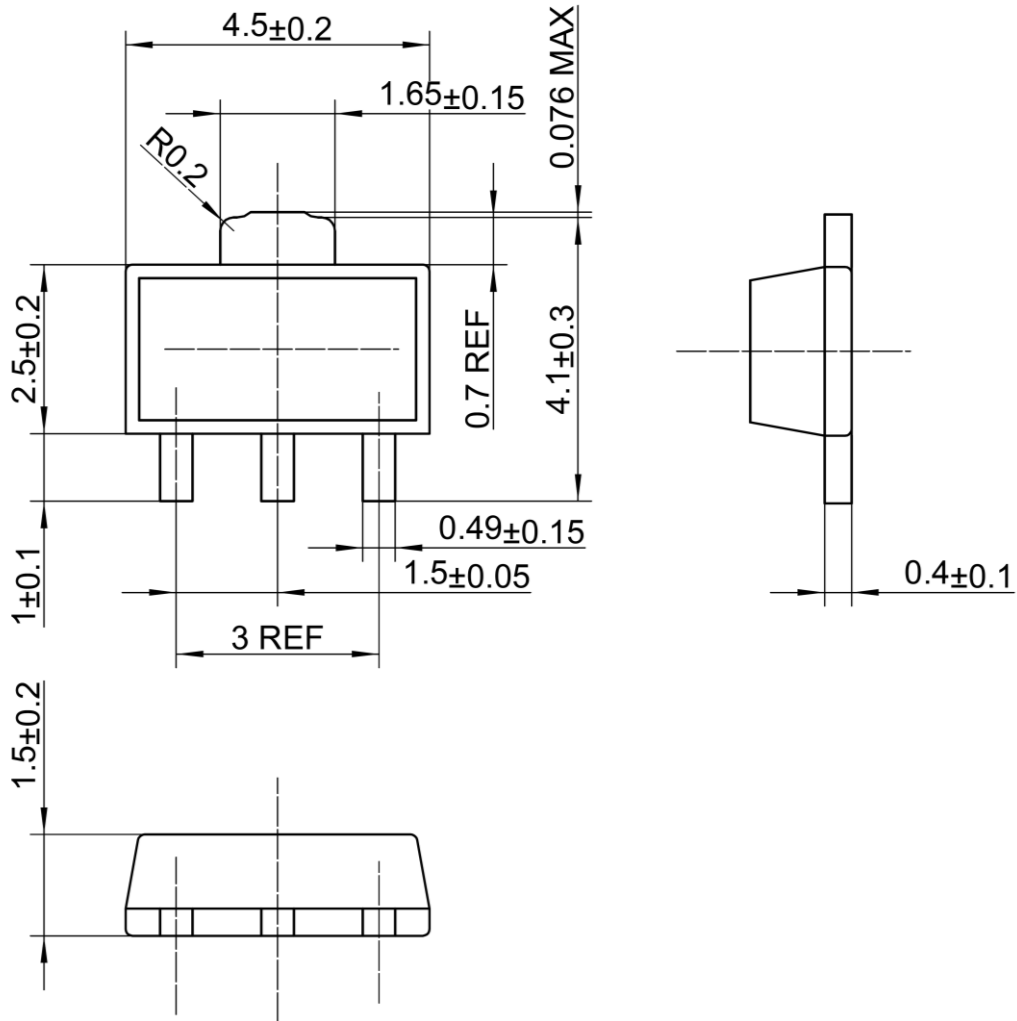

Figure 6. Maximum Rated Safe Operating Area



Package Dimensions

SOT-89



---

**Published by****ARK Microelectronics Co., Ltd.****ADD: D26,UESTC National Science Park No. 1 Shuangxing Avenue, Chengdu, Sichuan.****All Rights Reserved.****Disclaimers**

---

ARK Microelectronics Co., Ltd. reserves the right to make change without notice in order to improve reliability, function or design and to discontinue any product or service without notice. Customers should obtain the latest relevant information before orders and should verify that such information is current and complete. All products are sold subject to ARK Microelectronics Co., Ltd's terms and conditions supplied at the time of order acknowledgement.

ARK Microelectronics Co., Ltd. warrants performance of its hardware products to the specifications at the time of sale, Testing, reliability and quality control are used to the extent ARK Microelectronics Co., Ltd deems necessary to support this warrantee. Except where agreed upon by contractual agreement, testing of all parameters of each product is not necessary performed.

ARK Microelectronics Co., Ltd. does not assume any liability arising from the use of any product or circuit designs described herein. Customers are responsible for their products and applications using ARK Microelectronics Co., Ltd's components. To minimize risk, customers must provide adequate design and operating safeguards.

ARK Microelectronics Co., Ltd. does not warrant or convey any license either expressed or implied under its patent rights, nor the rights of others. Reproduction of information in ARK Microelectronics Co., Ltd's data sheets or data books is permissible only if reproduction is without modification or alteration. Reproduction of this information with any alteration is an unfair and deceptive business practice. ARK Microelectronics Co., Ltd is not responsible or liable for such altered documentation.

Resale of ARK Microelectronics Co., Ltd's products with statements different from or beyond the parameters stated by ARK Microelectronics Co., Ltd. for the product or service voids all express or implied warranties for the associated ARK Microelectronics Co., Ltd's product or service and is unfair and deceptive business practice. ARK Microelectronics Co., Ltd is not responsible or liable for any such statements.

---

**Life Support Policy:**

ARK Microelectronics Co., Ltd's products are not authorized for use as critical components in life devices or systems without the expressed written approval of ARK Microelectronics Co., Ltd.

As used herein:

1. Life support devices or systems are devices or systems which:
    - a. are intended for surgical implant into the human body,
    - b. support or sustain life,
    - c. whose failure to perform when properly used in accordance with instructions for used provided in the labeling, can be reasonably expected to result in significant injury to the user.
  2. A critical component is any component is any component of a life support device or system whose failure to perform can be reasonably expected to cause the failure of the life support device or system, or to affect its safety or effectiveness.
-

单击下面可查看定价，库存，交付和生命周期等信息

[>>ARK\(方舟微\)](#)