

### Data Sheet

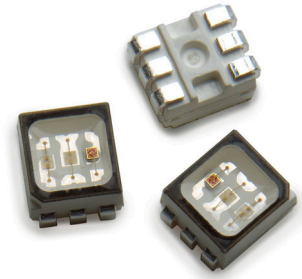

#### Description

The high brightness black top surface tri-color PLCC-6 family of SMT LEDs has a separate heat path for each LED dice, enabling the LED to be driven at higher current. These SMT LEDs are in the high brightness category, are high reliability devices, are high performance and are designed for a wide range of environmental conditions. By integrating the black top surface Avago devices deliver better contrast enhancement for your application. They also provide super wide viewing angle at 120° with the built in reflector pushing up the intensity of the light output. The high reliability characteristics and other features make the black top surface tri-color PLCC-6 family ideally suitable for exterior and interior full color signs application conditions.

For easy pick and place, the LEDs are shipped in EIA-compliant tape and reel. Every reel is shipped from a single intensity and color bin; except red color providing better uniformity. These tri-color LEDs are compatible with reflow soldering process.

**CAUTION** LEDs are Class 1C ESD sensitive. Please observe appropriate precautions during handling and processing. Please refer to Avago Application Note AN-1142 for additional details.

#### Features

- Industry Standard PLCC-6 package (Plastic Leaded Chip Carrier) with individual addressable pin-out for higher flexibility of driving configuration
- High reliability LED package with silicone encapsulation
- High brightness using AlInGaP and InGaN dice technologies
- Wide viewing angle at 120°
- Compatible with reflow soldering process
- JEDEC MSL 2a
- Water-Resistant (IPX6, see note) per IEC 60529:2001

**NOTE** The test is conducted on component level by mounting the components on PCB with proper potting to protect the leads. It is strongly recommended that customers perform necessary tests on the components for their final application.

#### Applications

- Indoor and outdoor full color display

## Package Dimensions

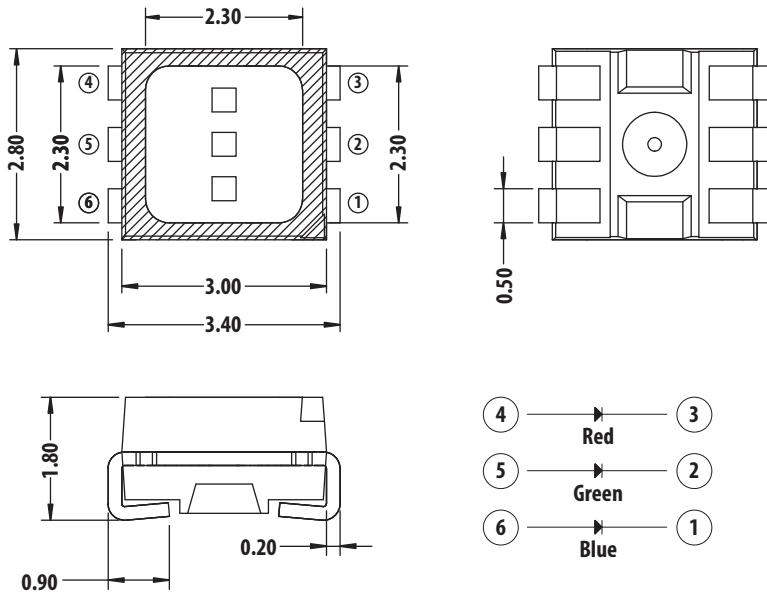

### NOTE

1. All dimensions are in millimeters.
2. Tolerance =  $\pm 0.2$  mm unless otherwise specified.
3. Terminal Finish: Ag plating.
4. Encapsulation material: silicone resin

Lead Configuration		
1	Cathode	Blue
2	Cathode	Green
3	Cathode	Red
4	Anode	Red
5	Anode	Green
6	Anode	Blue

## Device Selection Guide

Part Number	Color 1 – AllInGaP Red			Color 2 – InGaN Green			Color 3 – InGaN Blue					
	Min. Iv @20mA		Typ. Iv @ 20mA	Min. Iv @ 20mA		Typ. Iv @ 20mA	Min. Iv @ 20mA		Typ. Iv @ 20mA	Max Iv @ 20mA		
	Bin ID	(mcd)	(mcd)	Bin ID	(mcd)	(mcd)	Bin ID	(mcd)	(mcd)	(mcd)		
ASMT-YTB2-0BB02	U2	560	745	1125	W1	1125	1600	2240	T1	285	380	560

### NOTE

1. The luminous intensity Iv, is measured at the mechanical axis of the LED package and it is tested in pulsing condition. The actual peak of the spatial radiation pattern may not be aligned with this axis.
2. Tolerance = ± 12%.

## Part Numbering System

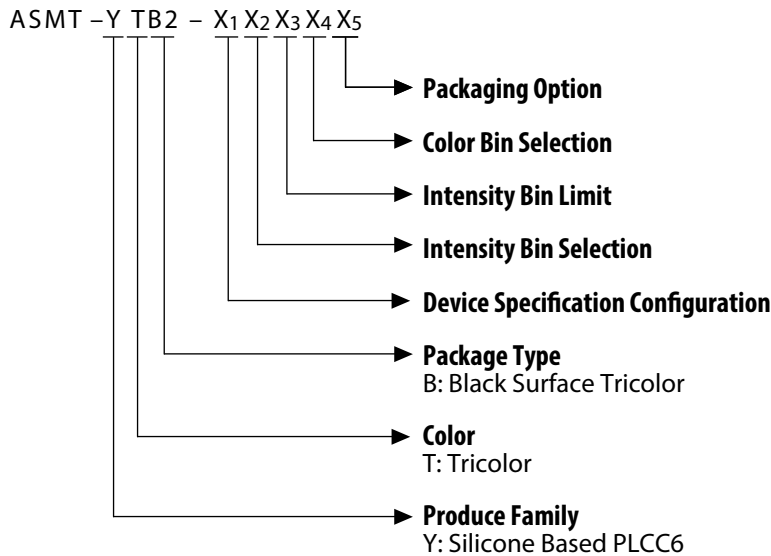

## Absolute Maximum Ratings ( $T_A = 25\text{ }^\circ\text{C}$ )

Parameter	Red	Green and Blue	Unit
DC forward current <sup>a</sup>	50	30	mA
Peak forward current <sup>b</sup>	100	100	mA
Power dissipation	125	114	mW
Reverse voltage	4V <sup>c</sup>		V
Maximum junction temperature $T_{j\text{ max}}$	125		$^\circ\text{C}$
Operating temperature range	-40 to +110 <sup>d</sup>		$^\circ\text{C}$
Storage temperature range	-40 to +120		$^\circ\text{C}$

- Derate linearly as shown in Figure 4 and Figure 5.
- Duty Factor = 10% Frequency = 1 KHz.
- Driving the LED in reverse bias condition is suitable for short term only.
- Refer to Figure 4 and Figure 5 for more information.

## Optical Characteristics ( $T_A = 25\text{ }^\circ\text{C}$ )

Color	Dominant Wavelength, $\lambda_d$ (nm) <sup>a</sup>			Peak Wavelength, $\lambda_p$ (nm)	Viewing Angle $2\theta_{1/2}$ <sup>b</sup> (Degrees)	Luminous Efficacy $\eta_V$ <sup>c</sup> (lm/W)	Luminous Efficiency $\eta_e$ (lm/W)
	Min	Typ.	Max	Typ.	Typ.	Typ.	Typ.
Red	618	622	628	629	120	210	43
Green	525	530	537	521	120	535	75
Blue	465	470	477	464	120	84	15

- The dominant wavelength is derived from the CIE Chromaticity Diagram and represents the perceived color of the device.
- $\theta_{1/2}$  is the off axis angle where the luminous intensity is  $1/2$  the peak intensity
- Radiant intensity,  $I_e$  in watts / steradian, may be calculated from the equation  $I_e = I_V / \eta_V$ , where  $I_V$  is the luminous intensity in candelas and  $\eta_V$  is the luminous efficacy in lumens / watt.

## Electrical Characteristics ( $T_A = 25\text{ }^\circ\text{C}$ )

Color	Forward Voltage, $V_F$ (V) <sup>a</sup>			Reverse Voltage $V_R$ @ 100 $\mu\text{A}$	Reverse Voltage $V_R$ @ 10 $\mu\text{A}$	Thermal Resistance $R\theta_{j-p}$ ( $^\circ\text{C/W}$ ) <sup>b</sup>
	Min	Typ.	Max.	Min.	Min.	Typ
Red	1.80	2.10	2.50	4	—	280
Green	-2.80	3.20	3.80	—	4	180
Blue	2.80	3.20	3.80	—	4	180

- Tolerance is  $\pm 0.1\text{V}$ .
- One chip on thermal resistance.

Figure 1 Relative Intensity vs. Wavelength

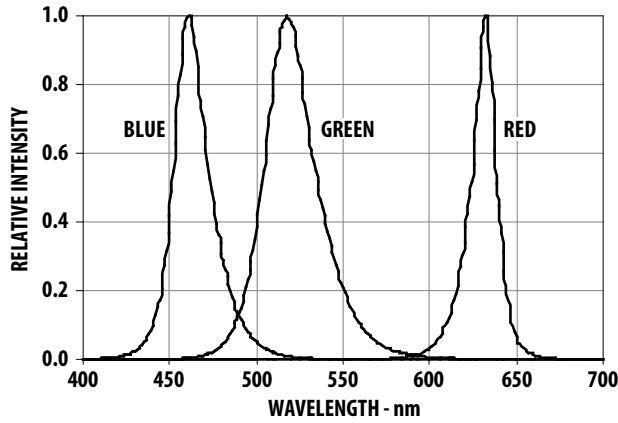

Figure 2 Forward Current – mA vs. Forward Voltage – V

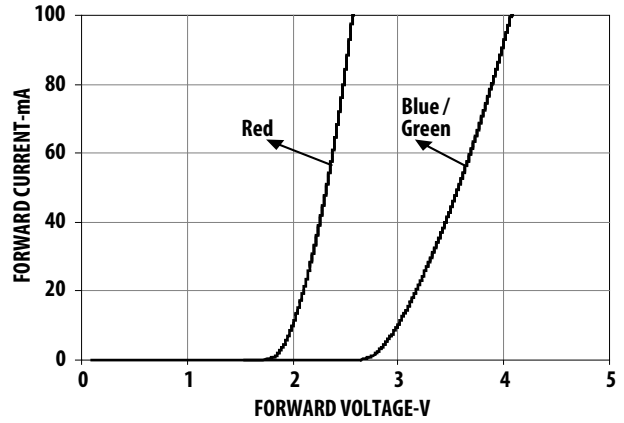

Figure 3 Relative Intensity vs. Forward Current

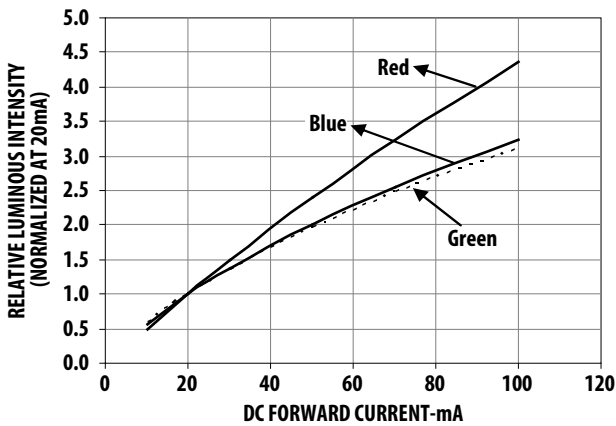

Figure 4 Maximum Forward Current vs Ambient Temperature. Derated based on  $T_{JMAX} = 125^\circ\text{C}$  (3 chips).

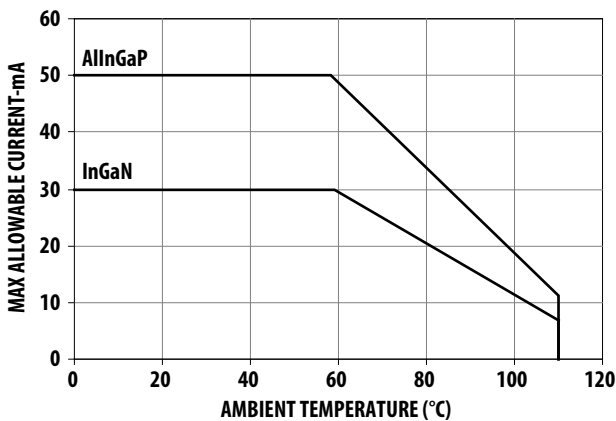

Figure 5 Maximum Forward Current vs Ambient Temperature. Derated based on  $T_{JMAX} = 125^\circ\text{C}$  (single chip).

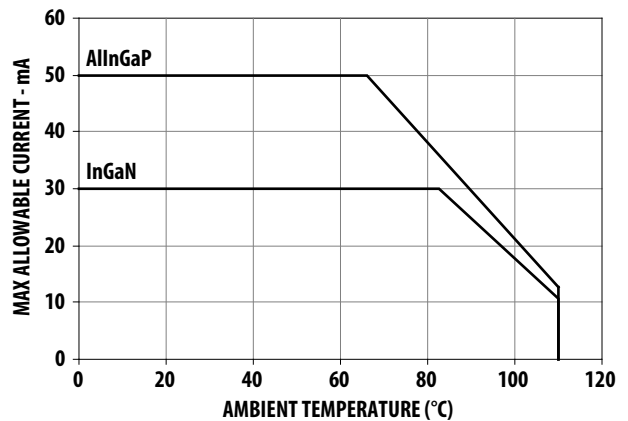

Figure 6 Radiation Pattern for X Axis

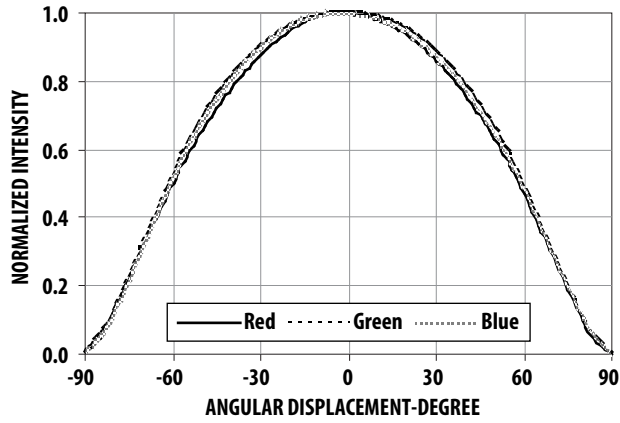

Figure 7 Radiation Pattern for Y Axis

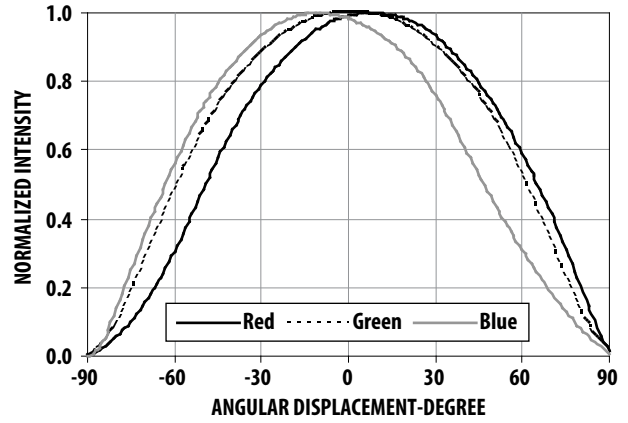

Figure 8 Component Access for Radiation Patterns

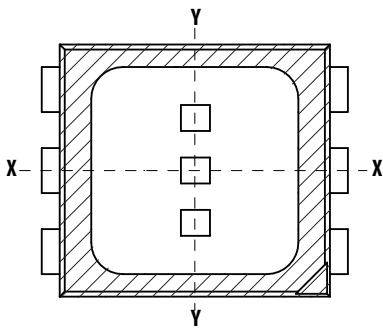

Figure 9 Relative Intensity vs. Junction Temperature

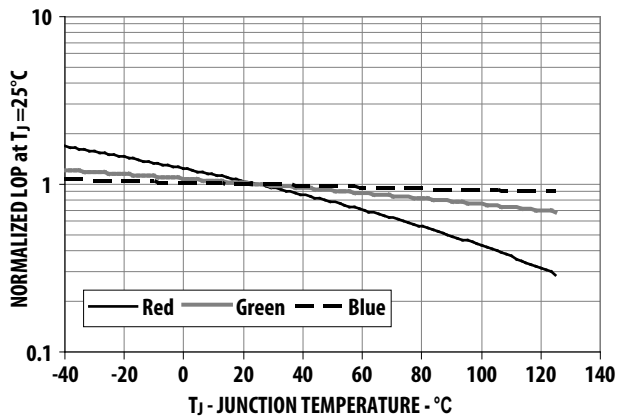

Figure 10 Forward Voltage vs. Junction Temperature

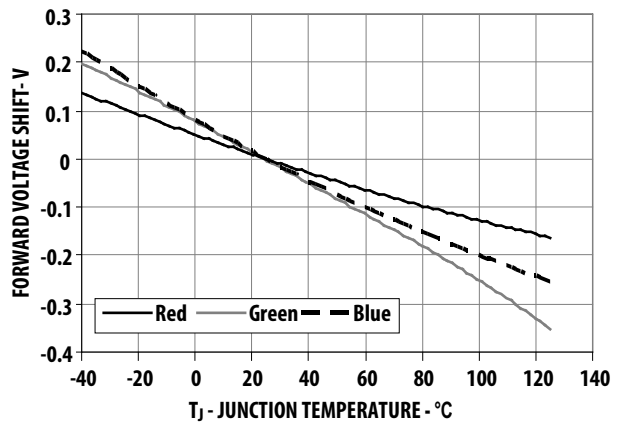

Figure 11 Recommended Soldering Land Pattern

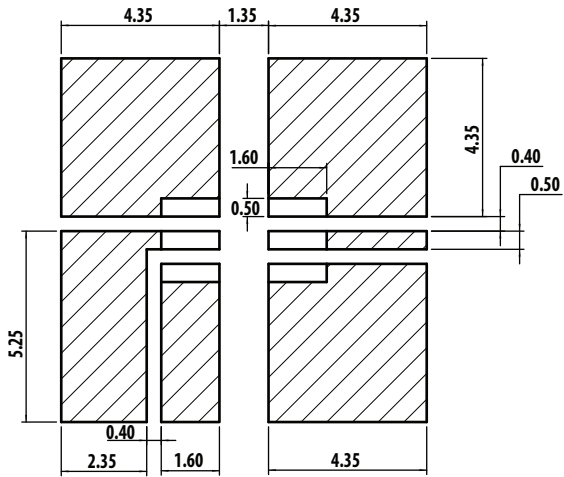

Figure 12 Carrier Tape Dimension

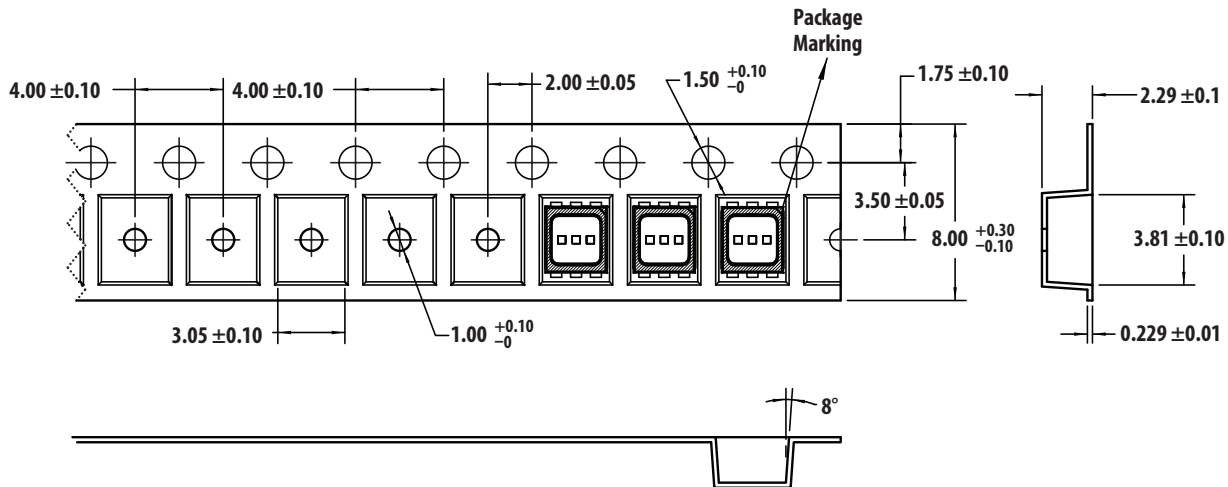

Figure 13 Reel Dimension

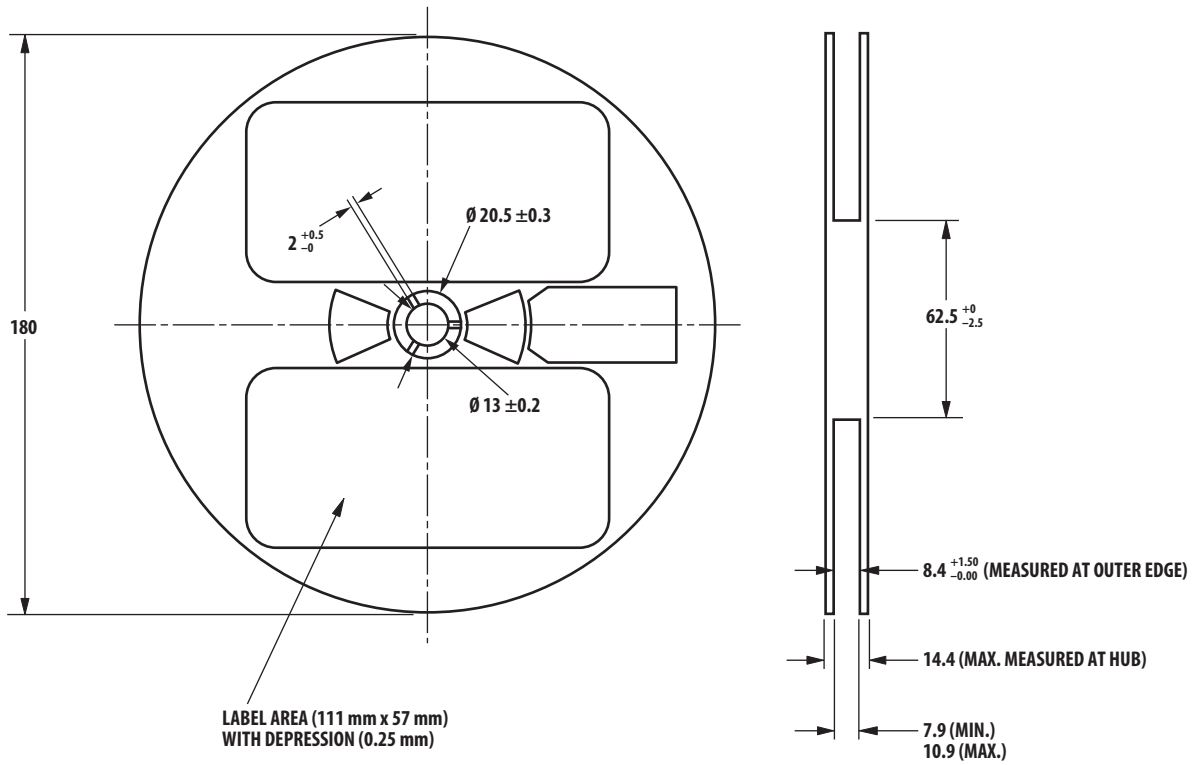
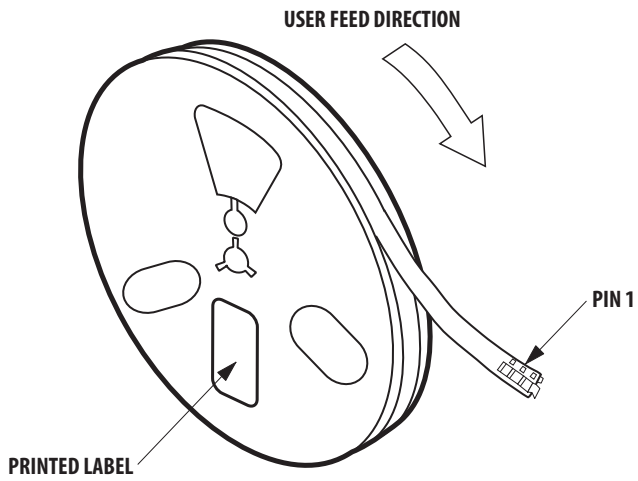













Figure 14 Reeling Orientation









## Packaging Label

(i) Avago Mother Label (Available on MBB bags)

<p>(1P) Item: Part Number  </p>		<p><b>AvAGO</b>  <small>TECHNOLOGIES</small>                  STANDARD LABEL LS0002                  RoHS Compliant Halogen Free                  e4 Max Temp 260C MSL2a                  (Q) QTY: Quantity  </p>
<p>(1T) Lot: Lot Number  </p>		
<p>LPN:  </p>	<p>CAT: Intensity Bin  </p>	
<p>(9D)MFG Date: Manufacturing Date  </p>	<p>BIN: Color Bin  </p>	
<p>(P) Customer Item:  </p>		
<p>(V) Vendor ID:  </p>	<p>(9D) Date Code: Date Code  </p>	
<p>DeptID:  </p>	<p>Made In: Country of Origin  </p>	

(ii) Avago Baby Label (Available on reel)

<p>(1P) PART #: Part Number  </p>		<p><b>AvAGO</b>  <small>TECHNOLOGIES</small>                  BABY LABEL COSB001B V0.0</p>
<p>(1T) LOT #: Lot Number  </p>		
<p>(9D)MFG DATE: Manufacturing Date  </p>	<p>QUANTITY: Packing Quantity  </p>	
<p>C/O: Country of Origin</p>	<p>(9D): DATE CODE:</p>	
<p>(1T) TAPE DATE:  </p>	<p>D/C: Date Code</p>	<p>VF:</p>
	<p>CAT: INTENSITY BIN</p>	
	<p>BIN: COLOR BIN</p>	

Example indicates luminous Intensity information for Red, Green and Blue respectively from label:



Example indicates color bin information for Green and Blue from label:

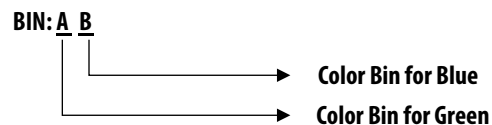

**NOTE** There will be no red color bin information appear on label as it is not binned and support with full distribution range.

## Intensity Bin Select (X<sub>2</sub>, X<sub>3</sub>)

Individual reel will contain parts from 1 half bin only.

X <sub>2</sub>	Min Iv Bin (Minimum Intensity Bin)		
	Red	Green	Blue
B	U2	W1	T1

X <sub>3</sub>	Number of Half bin from X <sub>2</sub>		
	Red	Green	Blue
B	3	3	3

## Color Bin Select (X<sub>4</sub>)

Individual reel will contain parts from 1 full bin only.

X <sub>4</sub>	Color Bin Combinations		
	Red	Green	Blue
0	Full distribution	A, B, C	A, B, C, D, E

## Intensity Bin Limits

Bin ID	Min (mcd)	Max (mcd)
T1	285.0	355.0
T2	355.0	450.0
U1	450.0	560.0
U2	560.0	715.0
V1	705.0	900.0
V2	900.0	1125.0
W1	1125.0	1400.0
W2	1400.0	1800.0
X1	1800.0	2240.0

**NOTE** Tolerance of each bin limit is ± 12%.

## Color Bin Limits

### Red Color Bin Table

Bin ID	Min. Dom	Max. Dom					
Full Distribution	618	628	x	0.6873	0.6696	0.6866	0.7052
			y	0.3126	0.3136	0.2967	0.2948

Tolerance of each bin limit is  $\pm 1$  nm.

### Green Color Bin Table

Bin ID	Min. Dom	Max. Dom					
A	525.0	531.0	x	0.1142	0.1799	0.2138	0.1625
			y	0.8262	0.6783	0.6609	0.8012
B	528.0	534.0	x	0.1387	0.1971	0.2298	0.1854
			y	0.8148	0.6703	0.6507	0.7867
C	531.0	537.0	x	0.1625	0.2138	0.2454	0.2077
			y	0.8012	0.6609	0.6397	0.7711

Tolerance of each bin limit is  $\pm 1$  nm.

### Blue Color Bin Table

Bin ID	Min. Dom	Max. Dom		1	2	3	4
A	465.0	469.0	x	0.1355	0.1751	0.168	0.127
			y	0.0399	0.0986	0.1094	0.053
B	467.0	471.0	x	0.1314	0.1718	0.1638	0.122
			y	0.0459	0.1034	0.1167	0.063
C	469.0	473.0	x	0.1267	0.168	0.1593	0.116
			y	0.0534	0.1094	0.1255	0.074
D	471.0	475.0	x	0.1215	0.1638	0.1543	0.1096
			y	0.0626	0.1167	0.1361	0.0868
E	473.0	477.0	x	0.1158	0.1593	0.1489	0.1028
			y	0.0736	0.1255	0.1490	0.1029

Tolerance of each bin limit is  $\pm 1$  nm.

### Packaging Option (X<sub>5</sub>)

Option	Test Current	Reel Size
2	20mA	7 inch

## Soldering

Recommended reflow soldering condition:

### (i) Leaded reflow soldering

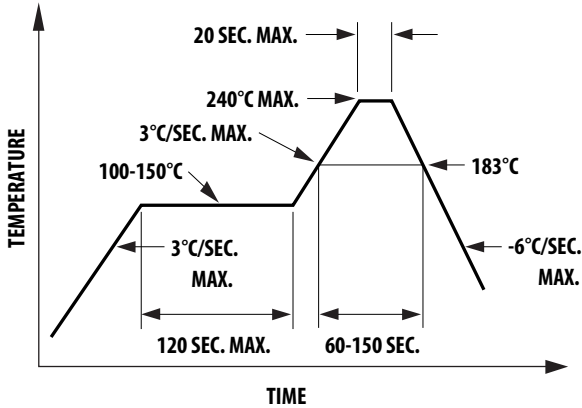

### (ii) Lead-free reflow soldering

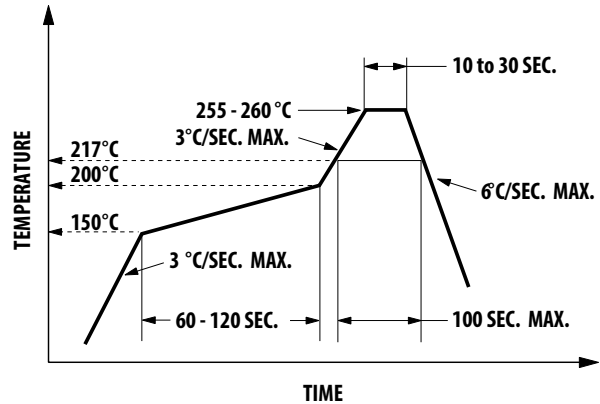

1. Reflow soldering must not be done more than 2 times. Make sure the necessary precautions are observed for handling moisture-sensitive device as stated in the following section.
2. Recommended board reflow direction:

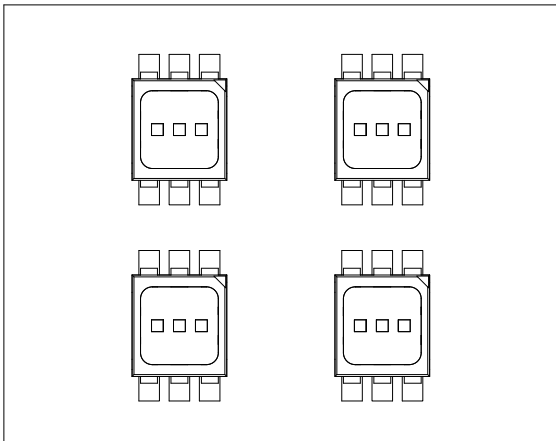

3. Do not apply any pressure or force on the LED during reflow and after reflow when the LED is still hot.
4. It is preferred to use reflow soldering to solder the LED. Use hand soldering for rework if this is unavoidable, but it must be strictly controlled to the following conditions:
  - Soldering iron tip temperature = 320 °C max
  - Soldering duration = 3 sec max
  - Number of cycles = 1 only
  - Power of soldering iron = 50 W max
5. Do not touch the LED body with hot soldering iron except the soldering terminals as it may cause damage to the LED.
6. For de-soldering, it is recommended that you use a double flat tip.
7. You are advised to confirm beforehand whether hand soldering will affect the functionality and performance of the LED.

## Precautionary Notes

### 1. Handling precautions

The encapsulation material of the LED is made of silicone for better product reliability. Compared to epoxy encapsulant that is hard and brittle, silicone is softer and flexible. Special handling precautions need to be observed during assembly of silicone encapsulated LED products. Failure to comply might lead to damage and premature failure of the LED. Do refer to Application Note AN5288, *Silicone Encapsulation for LED: Advantages and Handling Precautions*, for more information.

- a. Do not poke sharp objects into the silicone encapsulant. Sharp object like tweezers or syringes might apply excessive force or even pierce through the silicone and induce failures to the LED die or wire bond.
- b. Do not touch the silicone encapsulant. Uncontrolled force acting on the silicone encapsulant might result in excessive stress on the wire bond. The LED should only be held by the body.
- c. Do not stack assembled PCBs together. Use an appropriate rack to hold the PCBs.
- d. Surface of silicone material attracts dust and dirt easier than epoxy due to its surface tackiness. To remove foreign particles on the surface of silicone, a cotton bud can be used with isopropyl alcohol (IPA). During cleaning, rub the surface gently without putting much pressure on the silicone. Ultrasonic cleaning is not recommended.
- e. For automated pick and place, Avago has tested nozzle size below to be working fine with this LED. However, due to the possibility of variations in other parameters such as pick and place machine maker/model and other settings of the machine, customer is recommended to verify the nozzle selected will not cause damage to the LED.

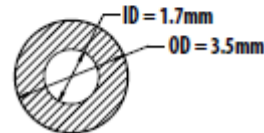
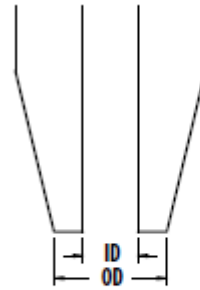

### 2. Handling of moisture sensitive device

This product has a Moisture Sensitive Level 3 rating per JEDEC J-STD-020. Refer to Avago Application Note AN5305, *Handling of Moisture Sensitive Surface Mount Devices*, for additional details and a review of proper handling procedures.

- a. Before use
  - An unopened moisture barrier bag (MBB) can be stored at <math><40\text{ }^\circ\text{C}/90\%\text{RH}</math> for 12 months. If the actual shelf life has exceeded 12 months and the humidity Indicator Card (HIC) indicates that baking is not required, then it is safe to reflow the LEDs per the original MSL rating.
  - It is recommended that the MBB not be opened prior to assembly (e.g., for IQC).
- b. Control after opening the MBB
  - The humidity indicator card (HIC) shall be read immediately upon opening of MBB.
  - The LEDs must be kept at <math><30\text{ }^\circ\text{C}/60\%\text{RH}</math> at all times and all high temperature related processes including soldering, curing or rework need to be completed within 168 hours.
- c. Control for unfinished reel
  - Unused LEDs must be stored in a sealed MBB with desiccant or desiccator at <math><5\%\text{RH}</math>.
- d. Control of assembled boards
  - If the PCB soldered with the LEDs is to be subjected to other high temperature processes, the PCB need to be stored in sealed MBB with desiccant or desiccator at <math><5\%\text{RH}</math> to ensure that all LEDs have not exceeded their floor life of 168 hours.

- e. Baking is required if:
- The HIC indicator is not BROWN at 10% and is AZURE at 5%.
  - The LEDs are exposed to condition of >30°C / 60% RH at any time.
  - The LED floor life exceeded 168hrs.

The recommended baking condition is: 60±5°C for 20hrs

Baking should only be done once.

- f. Storage

The soldering terminals of these Avago LEDs are silver plated. If the LEDs are being exposed in ambient environment for too long, the silver plating might be oxidized and thus affecting its solderability performance. As such, unused LEDs must be kept in sealed MBB with desiccant or in desiccator at <5%RH.

### 3. Application precautions

- a. Drive current of the LED must not exceed the maximum allowable limit across temperature as stated in the data sheet. Constant current driving is recommended to ensure consistent performance.
- b. LEDs do exhibit slightly different characteristics at different drive current which might result in larger variation their performance (i.e., intensity, wavelength and forward voltage). User is recommended to set the application current as close as possible to the test current in order to minimize these variations.
- c. LED is not intended for reverse bias. Do use other appropriate components for such purpose. When driving the LED in matrix form, it is crucial to ensure that the reverse bias voltage is not exceeding the allowable limit of the LED.
- d. Do not use the LED in the vicinity of material with sulfur content, in environment of high gaseous sulfur compound and corrosive elements. Examples of material that may contain sulfur are rubber gasket, RTV (room temperature vulcanizing) silicone rubber, rubber gloves etc. Prolonged exposure to such environment may affect the optical characteristics and product life.
- e. Avoid rapid change in ambient temperature especially in high humidity environment as this will cause condensation on the LED.
- f. Although the LED is rated as IPx6 according to IEC60529: Degree of protection provided by enclosure, the test condition may not represent actual exposure during application. If the LED is intended to be used in outdoor or harsh environment, the LED must be protected against damages caused by rain water, dust, oil, corrosive gases, external mechanical stress, etc.

### 4. Thermal management

Optical, electrical and reliability characteristics of LED are affected by temperature. The junction temperature ( $T_J$ ) of the LED must be kept below allowable limit at all times.  $T_J$  can be calculated as below:

$$T_J = T_A + R\theta_{J-A} \times I_F \times V_{Fmax}$$

where;

$T_A$  = ambient temperature (°C)

$R\theta_{J-A}$  = thermal resistance from LED junction to ambient (°C/W)

$I_F$  = forward current (A)

$V_{Fmax}$  = maximum forward voltage (V)

The complication of using this formula lies in  $T_A$  and  $R\theta_{J-A}$ . Actual  $T_A$  is sometimes subjective and hard to determine.  $R\theta_{J-A}$  varies from system to system depending on design and is usually not known.

Another way of calculating  $T_J$  is by using solder point temperature  $T_S$  as shown below:

$$T_J = T_S + R\theta_{J-S} \times I_F \times V_{Fmax}$$

where;

$T_S$  = LED solder point temperature as shown in illustration below (°C)

$R\theta_{J-S}$  = thermal resistance from junction to solder point (°C/W)

$T_S$  can be measured easily by mounting a thermocouple on the soldering joint as shown in illustration above, while  $R\theta_{J-S}$  is provided in the data sheet. User is advised to verify the  $T_S$  of the LED in the final product to ensure that the LEDs are operated within all maximum ratings stated in the data sheet.

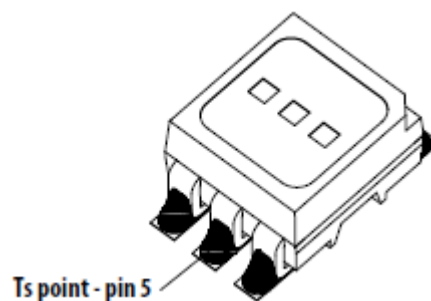

### 5. Eye safety precautions

LEDs may pose optical hazards when in operation. It is not advisable to view directly at operating LEDs as it may be harmful to the eyes. For safety reasons, use appropriate shielding or personal protective equipments.

## 6. Disclaimer

Avago's products are not specifically designed, manufactured or authorized for sale as parts, components or assemblies for the planning, construction, maintenance or direct operation of a nuclear facility or for use in medical devices or applications. Customer is solely responsible, and waives all rights to make claims against Avago or its suppliers, for all loss, damage, expense or liability in connection with such use.

---

For product information and a complete list of distributors, please go to our web site:

[www.avagotech.com](http://www.avagotech.com)

Avago Technologies and the A logo are trademarks of Avago Technologies in the United States and other countries. All other brand and product names may be trademarks of their respective companies.

Data subject to change. Copyright © 2014–2016 Avago Technologies. All Rights Reserved.

AV02-2583EN – April 6, 2016

**AVAGO**  
TECHNOLOGIES



Lead (Pb) Free  
RoHS 6 fully  
compliant

单击下面可查看定价，库存，交付和生命周期等信息

[>>AVAGO](#)