

RF/Microwave Multilayer Capacitors (MLC)

CDR Series – MIL-PRF-55681/4/5 (RF/Microwave Chips)

HOW TO ORDER

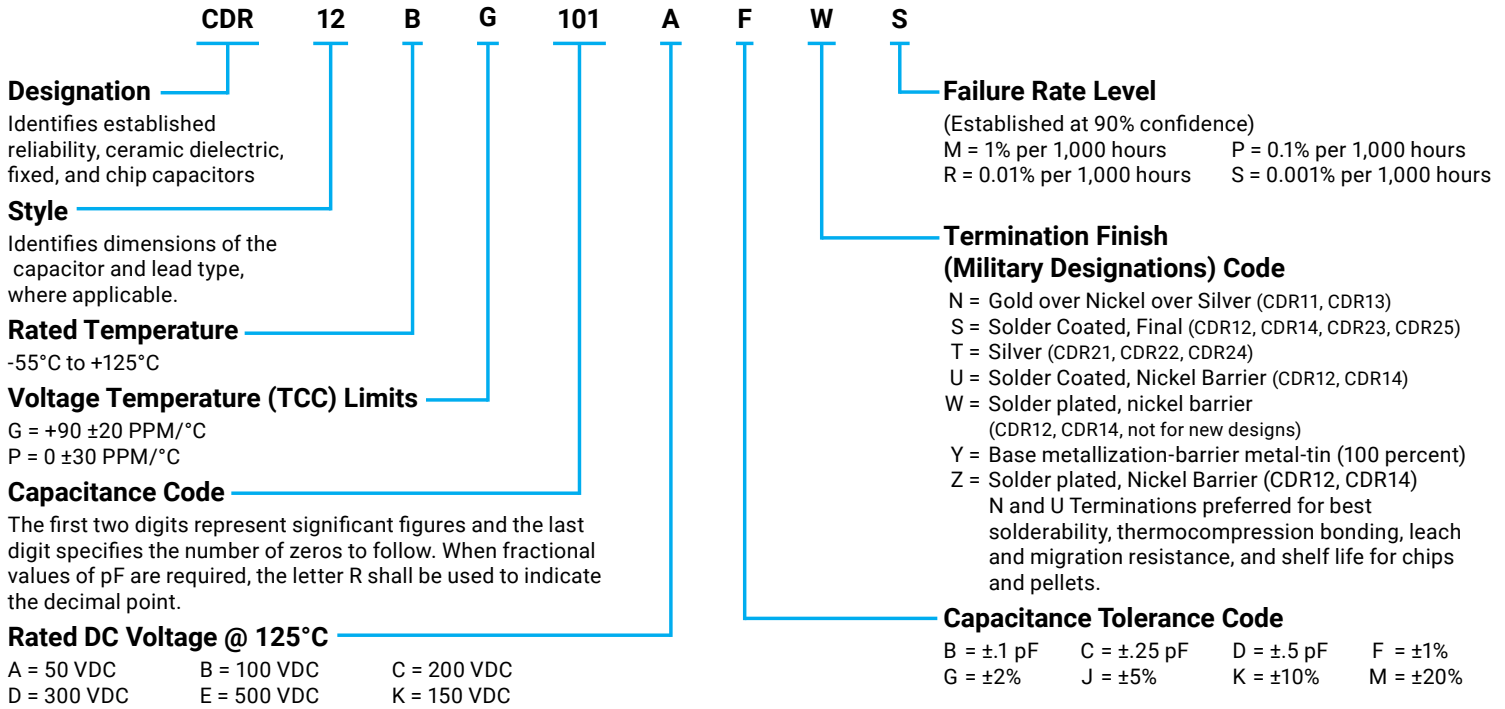

TABLE I - STYLES CDR11 AND CDR12 CAPACITOR CHARACTERISTICS

Type Designation *	Capacitance Range (pF)	Capacitance Tolerance Available	Rated Temp. & Voltage-Temp Limits	Rated DC Voltage
CDR1-B-0R1KB-- to CDR1-B-0R2--B--	0.1 pF to 0.2 pF	B	Characteristic BG (+90 ±20 PPM/°C) and Characteristic BP (0 ±30 PPM/°C)	A = 50 K = 150
CDR1-B-0R3K--- to CDR1-B-0R4---	0.3 pF to 0.4 pF	B, C		
CDR1-B-0R5K--- to CDR1-B-2R2---**	0.5 pF to 2.2 pF	B, C, D		
CDR1-B-2R4K--- to CDR1-B-6R2---***	2.4 pF to 6.2 pF	B, C, D		
CDR1-B-6R8K--- to CDR1-B-9R1---***	6.8 pF to 9.1 pF	B, C, J, K, M		
CDR1-B-100K--- to CDR1-B-101K---***	10 pF to 100 pF	F, G, J, K, M		
CDR1-BP111K-- to CDR1-BP621---***	110 pF to 620 pF	F, G, J, K, M	BP	A = 50 B = 100
CDR1-BP681A-- to CDR1-BP102---***	680 pF to 1000 pF	F, G, J, K, M		

TABLE II - STYLES CDR13 AND CDR14 CAPACITOR CHARACTERISTICS

Type Designation *	Capacitance Range (pF)	Capacitance Tolerance Available	Rated Temp. & Voltage-Temp Limits	Rated DC Voltage
CDR1-B-0R1EB-- to CDR1-B-0R2---B--	0.1 pF to 0.2 pF	B	"Characteristic BG (+90 ±20 PPM/°C) and Characteristic BP (0 ±30 PPM/°C)"	
CDR1-B-0R3E--- to CDR1-B-0R4---	0.3 pF to 0.4 pF	B, C		
CDR1-B--0R5E--- to CDR1-B-2R2---**	0.5 pF to 2.2 pF	B, C, D		C = 200
CDR1-B-2R4E--- to CDR1-B-6R2---***	2.4 pF to 6.2 pF	B, C, D		E = 500
CDR1-B-6R8E--- to CDR1-B-9R1---***	6.8 pF to 9.1 pF	B, C, J, K, M		
CDR1-B-100E--- to CDR1-B-101---***	10 pF to 100 pF	F, G, J, K, M		
CDR1-B-111D--- to CDR1-B-201---***	110 pF to 200 pF			C = 200 D = 300
CDR1-B-221C--- to CDR1-B-471C---***	220 pF to 470 pF			C = 200
CDR1-B-511B--- to CDR1-B-621---***	510 pF to 620 pF			A = 50 B = 100
CDR1-B-681A--- to CDR1-B-102A---***	680 pF to 1000 pF			
CDR1-BP112A--- to CDR1-BP512A---***	1100 pF to 5100 pF			A = 50
			BP	

* Complete type designation will include additional symbols to indicate style, voltage-temperature limits, capacitance tolerance (where applicable), termination finish, and failure rate level.
 ** Intermediate values in this category are in 0.1 pF steps.
 *** Intermediate values in each category are given by the RETMA 5% Table.

RF/Microwave Multilayer Capacitors (MLC)

CDR Series – MIL-PRF-55681/4/5 (RF/Microwave Chips)

TABLE III - STYLES CDR21-CDR25 CAPACITOR CHARACTERISTICS

Type Designation *	Capacitance Range (pF)	Capacitance Tolerance Available	Rated Temp. & Voltage-Temp Limits	Rated DC Voltage
CDR2-B-0R1EB-- to CDR2-B-0R2EB--	0.1 pF to 0.2 pF	B	Characteristic BG (+90 ±20 PPM/°C) and Characteristic BP (0 ±30 PPM/°C)	500 = E
CDR2-B-0R3E--- to CDR2-B-0R4E---	0.3 pF to 0.4 pF	B, C		
CDR2-B-0R5E--- to CDR2-B-2R2E---**	0.5 pF to 2.2 pF	B, C, D		
CDR2-B-2R4E--- to CDR2-B-6R2E---***	2.4 pF to 6.2 pF	B, C, D		
CDR2-B-6R8E--- to CDR2-B-9R1E---***	6.8 pF to 9.1 pF	B, C, J, K, M		
CDR21-B-100E--- to CDR2-B-101E---***	10 pF to 100 pF	F, G, J, K, M		300 = D
CDR2-B-111D--- to CDR2-B-201D---***	110 pF to 200 pF			200 = C
CDR2-B-221C--- to CDR2-B-471C---***	220 pF to 470 pF			100 = B
CDR2-B-511B--- to CDR2-B-621B---***	510 pF to 620 pF			50 = A
CDR2-B-681A--- to CDR2-B-102A---***	680 pF to 1000 pF			
CDR2-BP112A-- to CDR2-BP512A---***	1100 pF to 5100 pF		BP	

* Complete type designation will include additional symbols to indicate style, voltage-temperature limits, capacitance tolerance (where applicable), termination finish (T for styles CDR21, CDR22 and CDR24, and S for styles CDR23 and CDR25), and failure rate level. Please note: Leaded devices CDR 21 through CDR 25 are available to the R Failure Rate Level only.

** Intermediate values in this category are in 0.1 pF steps.

*** Intermediate values in each category are given by the RETMA 5% Table as follows: 10, 11, 12, 13, 15, 16, 18, 20, 22, 24, 27, 30, 33, 36, 39, 43, 47, 51, 56, 62, 68, 75, 82, 91.

TABLE I - STYLES CDR11 AND CDR12 CAPACITOR CHARACTERISTICS

MIL-PRF-55681 Styles	Case Size	Type	Outlines	Body Dimensions			Lead & Termination Dimensions & Materials		
				Length	Width	Thickness			
CDR 11	A	Chip CA	W/T is a Termination Surface	.055 ±.015 (1.4 ±0.38)		.020/.057 (0.51/1.45)	N = Gold Over Nickel Over Silver N is ATC's UNI-TERM®		
CDR 13	B	Chip CA		.110 ±.020 (2.79 ±0.51)		.030/.102 (0.76/2.59)			
CDE 12	A	Pellet P	W/T is a Termination Surface	.055 ±.025 (1.4 ±0.63)	.055 ±.015 (1.4 ±0.38)	.020/.057 (0.51/1.45)	S = Solder Coated, Final U = Solder Coated, Nickel Barrier U is ATC's BARRIER//CAP®		
CDR 14	B	Pellet P		.110 +.035 -.020 (2.79 +0.89 -0.51)	.110 ±.020 (2.79 ±0.51)	.030/.102 (0.76/2.59)			
CDR 12	A	Solder Plate W	W/T is a Termination Surface	.055 ±.015 (1.4 ±0.38)		.020/.057 (0.51/1.45)	W = Nickel Barrier, Solder Plate.		
CDR 14	B	Solder Plate W		.110 ±.020 (2.79 ±0.51)		.030/.102 (0.76/2.59)			
CDR 21	B	Microstrip MS		.135 ±.015 (3.43 ±0.38)	.110 ±.015 (2.79 ±0.38)	.060/.100 (1.52/2.54)	Termination T = Silver		
CDR 22	B	Axial Ribbon AR					Length	Width	Thickness
CDR 24	B	Radial Ribbon RR					min.	.093±.005 (2.36±0.13)	.004±.001 (0.10±0.03)
CDR 23	B	Radial Wire RW					.250 (6.35)		
CDR 25	B	Axial Wire AW					Terminations S = Solder Coated		
							min.	#26 AWG	
							.50 (12.7)	.016 (.375) dia. nom.	

All dimensions are in inches, except those in parentheses which are in millimeters.

All leads and ribbon are silver and are attached with high temperature solder.

RF/Microwave Multilayer Capacitors (MLC)

CDR Series – MIL-PRF-55681/4/5 (RF/Microwave Chips)

Style	Equiv. KYOCERA AVX Part No. Characteristics	
	BG	BP
CDR11	100A	700A
CDR12	100A	700A
CDR13	100B	700B
CDR14	100B	700B

Style	Equiv. KYOCERA AVX Part No. Characteristics	
	BG	BP
CDR21	100B ----- MS	700B ----- MS
CDR22	100B ----- AR	700B ----- AR
CDR23	100B ----- RW	700B ----- RW
CDR24	100B ----- RR	700B ----- RR
CDR25	100B ----- AW	700B ----- AW

PACKAGING

Standard Packaging Quantity
 CDR11-12 = 100 pcs per waffle pack
 CDR13-14 = 100 pcs per waffle pack

TAPE & REEL

All tape and reel specifications are in compliance with EIA RS481 (equivalent to IEC 286 part 3).
 Sizes CDR11/12 through 13/14.
 – 8mm carrier
 – 7" reel: ≤ 0.040 " thickness = 100, 300, 500, 1000, 2000* pcs
 ≤ 0.075 " thickness = 100, 300, 500, 1000, 2000* pcs
 * QTY 2000 only applies to CDR11-12

RF/Microwave Multilayer Capacitors (MLC) Performance Curves



TYPICAL Q vs. FREQUENCY
MIL-PRF-55681E - BG

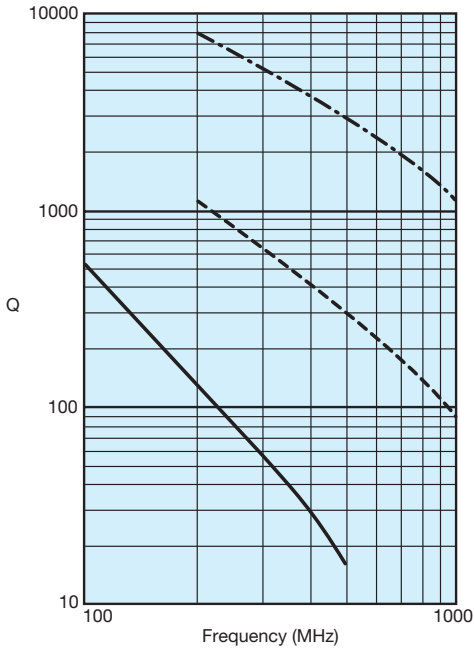

--- 1 Picofarad - - - 10 Picofarad — 100 Picofarad

TYPICAL ESR vs. FREQUENCY
MIL-PRF-55681E - BG

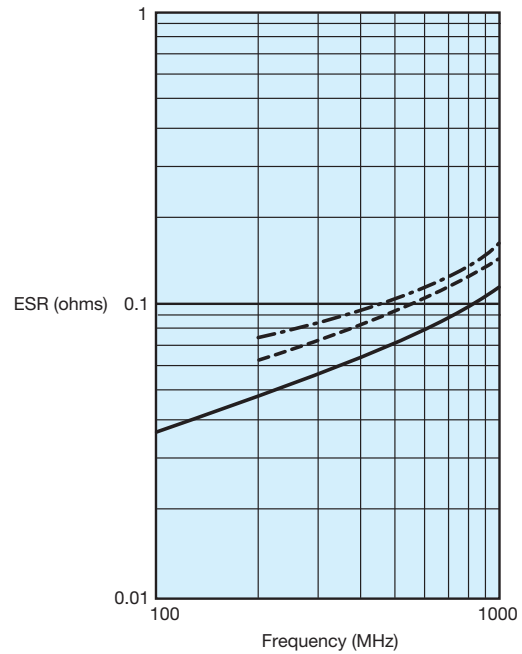

--- 3.3 Picofarad - - - 10 Picofarad — 100 Picofarad

TYPICAL Q vs. CAPACITANCE
MIL-PRF-55681E - BG

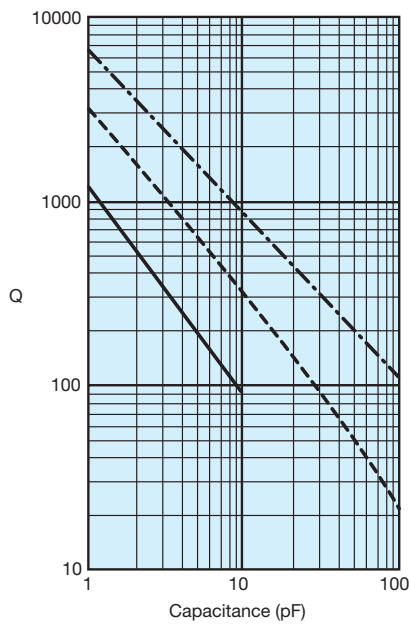

--- 250 MHz - - - 500 MHz — 1000 MHz

TYPICAL ESR vs. CAPACITANCE
MIL-PRF-55681E - BG

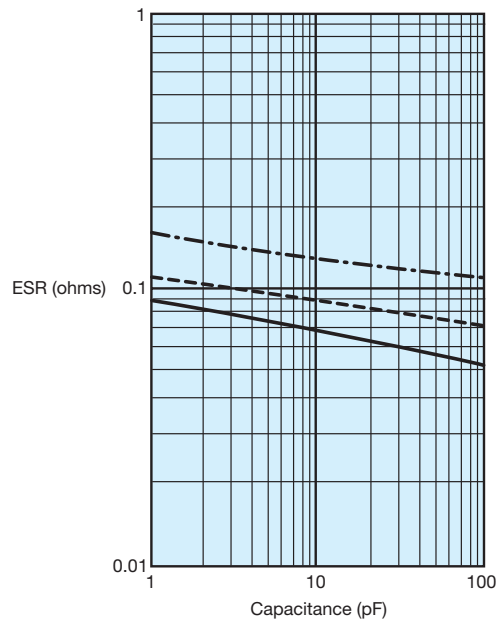

--- 250 MHz - - - 500 MHz - - - 1000 MHz

RF/Microwave Multilayer Capacitors (MLC) Performance Curves

TYPICAL Q vs. FREQUENCY
MIL-PRF-55681E - BG

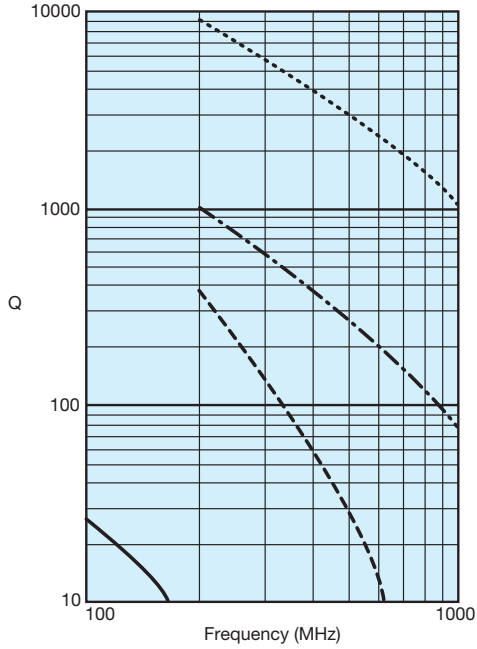

----- 1 Picofarad - - - - 10 Picofarad - - - - 47 Picofarad ——— 330 Picofarad

TYPICAL ESR vs. FREQUENCY
MIL-PRF-55681E - BG

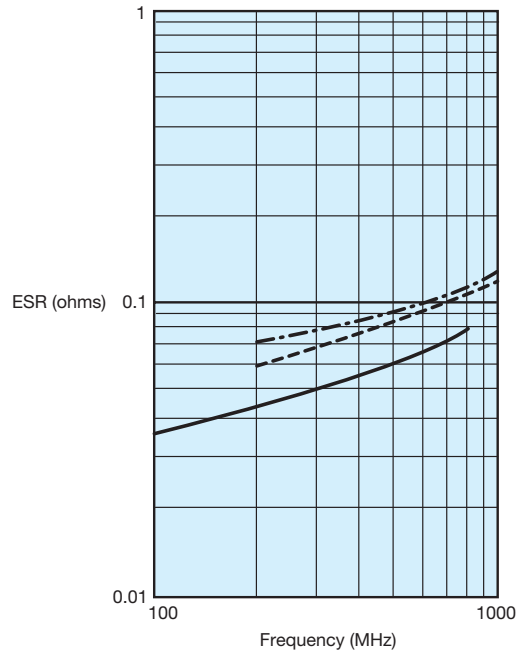

----- 1 Picofarad - - - - 15 Picofarad ——— 100 Picofarad

TYPICAL Q vs. CAPACITANCE
MIL-PRF-55681E - BG

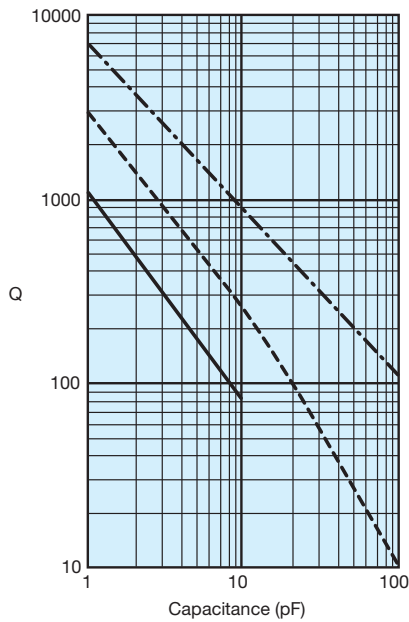

----- 250 MHz - - - - 500 MHz ——— 1000 MHz

TYPICAL ESR vs. CAPACITANCE
MIL-PRF-55681E - BG

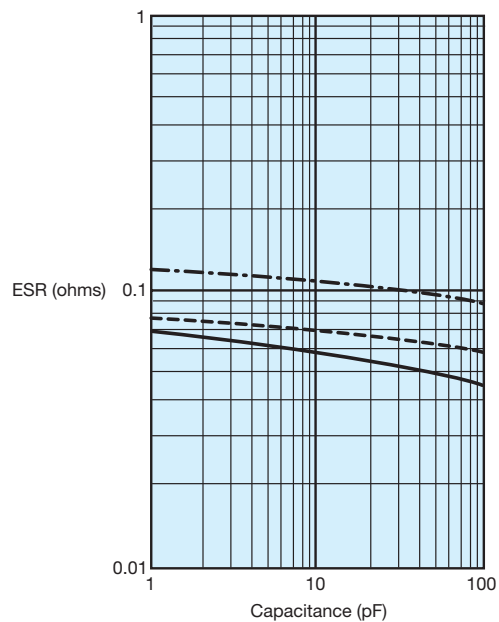

----- 250 MHz - - - - 500 MHz - - - - 1000 MHz

RF/Microwave Multilayer Capacitors (MLC) Performance Curves

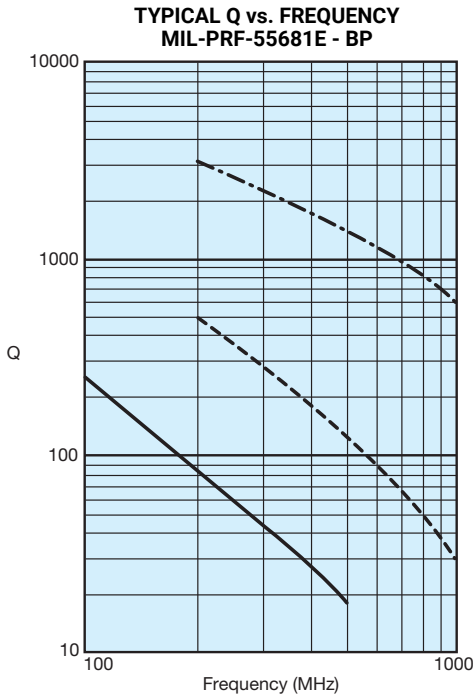

--- 1 Picofarad - - - 15 Picofarad — 100 Picofarad

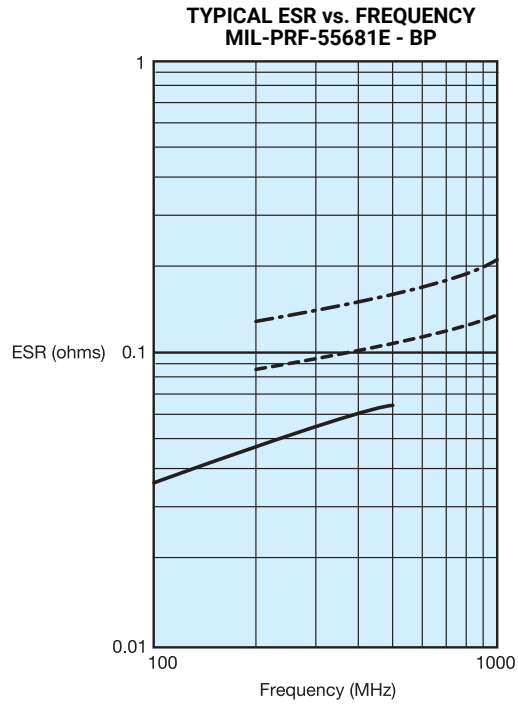

--- 15 Picofarad - - - 47 Picofarad — 100 Picofarad

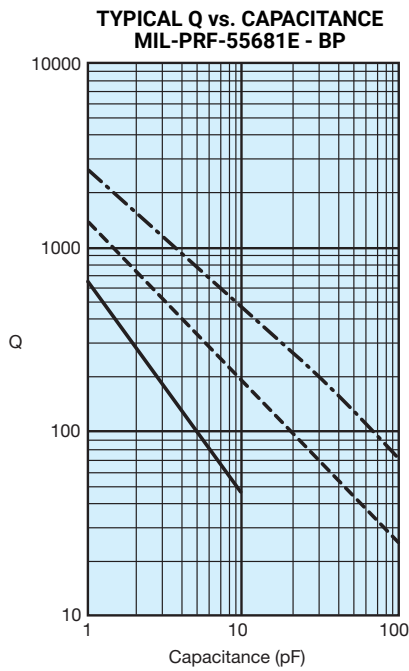

--- 250 MHz - - - 500 MHz — 1000 MHz

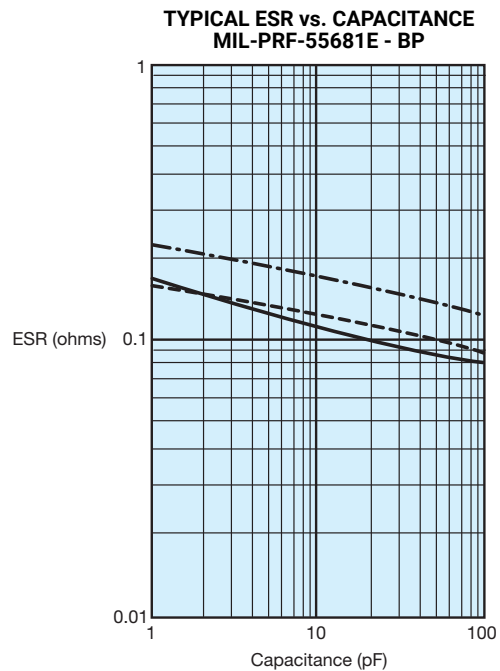

--- 250 MHz - - - 500 MHz — 1000 MHz

RF/Microwave Multilayer Capacitors (MLC) Performance Curves

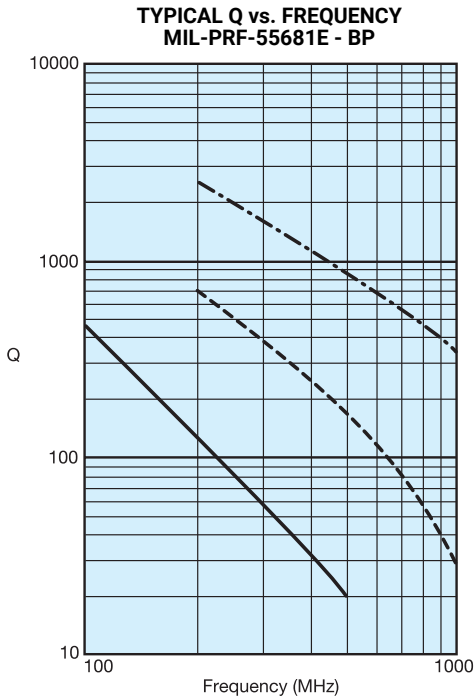

--- 2 Picofarad - - - 15 Picofarad — 100 Picofarad

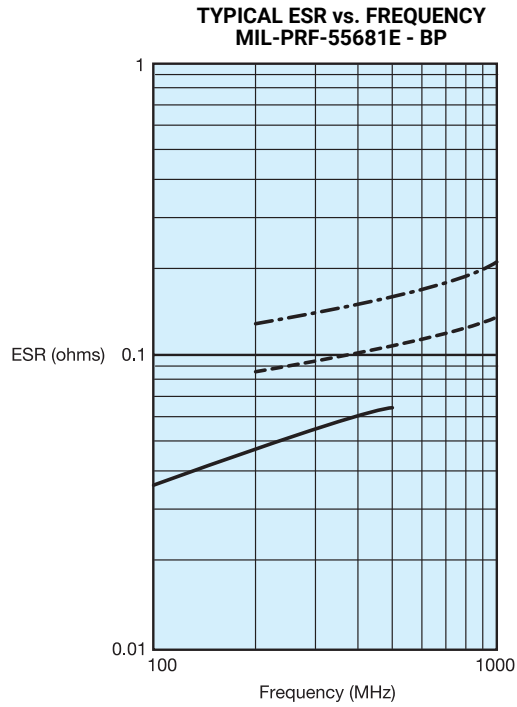

--- 15 Picofarad - - - 47 Picofarad — 100 Picofarad

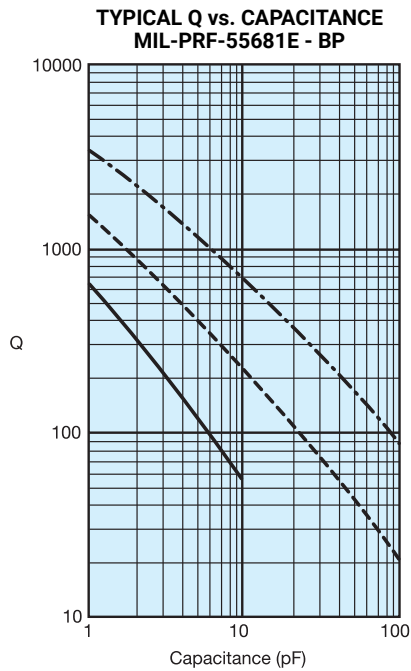

--- 250 MHz - - - 500 MHz — 1000 MHz

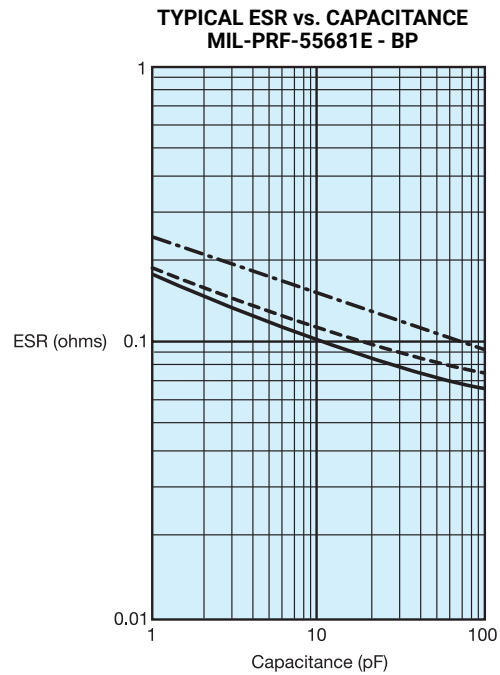

--- 250 MHz - - - 500 MHz — 1000 MHz

RF/Microwave Multilayer Capacitors (MLC) Performance Curves



TYPICAL RESONANT FREQUENCY vs. CAPACITANCE
(CDR11-14)

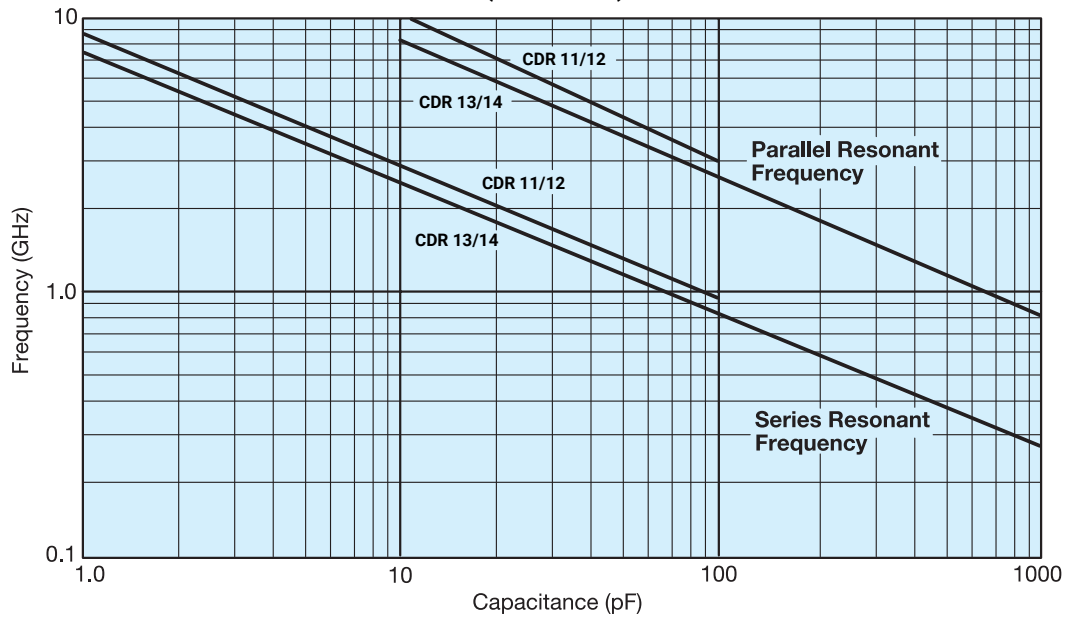

单击下面可查看定价，库存，交付和生命周期等信息

[>>AVX](#)