

# Male Style 1/2 B Press-Fit



## Series 8458 – 2 rows (2 x 16)



Contact Design and Termination Length	Number of Contacts	Loading Description	Part Number Performance classes according to DIN 41612	
			II	I
for ≥ 2.4 mm PCB's 5.3 mm (Y) Right Angled	32	a + b fully loaded	10 8458 032 001 025	10 8458 032 001 049
	16	a loading only	10 8458 032 001 027	10 8458 032 001 051
	30 + 2	fully loaded + ground	10 8458 032 101 025	10 8458 032 101 049
for 1.6 mm PCB's 3.0 mm (Y) Right Angled	32	a + b fully loaded	10 8458 032 031 025	10 8458 032 031 049
	16	a loading only	10 8458 032 031 027	10 8458 032 031 051
	30 + 2	fully loaded + ground	10 8458 032 131 025	10 8458 032 131 049

NB: Alternative Prefix Variations Available: 12, please refer to Page 10.

Additional Plating & Loading Variations: Please contact your local AVX sales office or distributor.

### LOADING DESCRIPTION

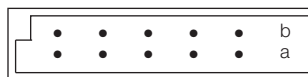

32 contacts, rows a + b fully loaded

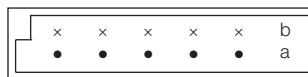

16 contacts, row a loading only

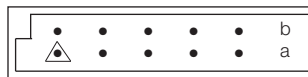

30 + 2 contacts, fully loaded with ground in A1 & A16

△ denotes ground pin

### DIMENSIONS

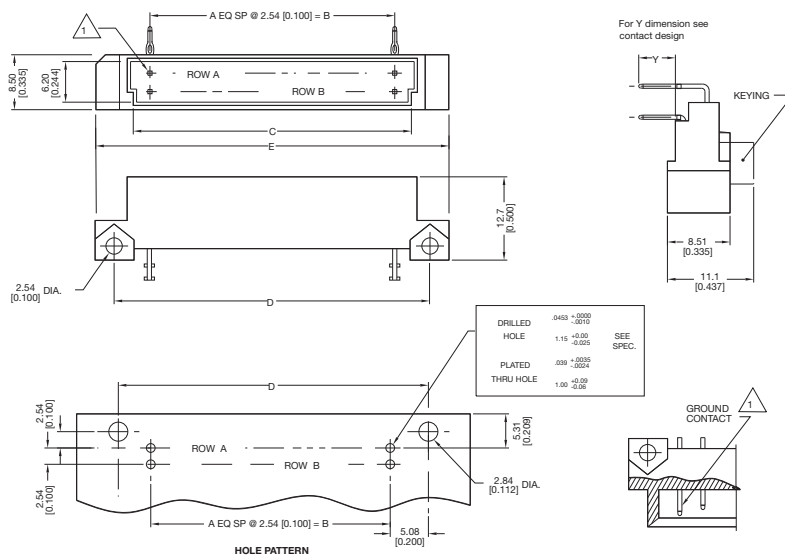

Assembly Tool: 06 8458 9221 00 000 (see page 67)

Unit: millimeters (inches)

No. Contact Positions	Contact Rows	A	B	C	D	E
32	2 (2 x 16)	15	38.10 (1.500)	44.55 (1.754)	48.26 (1.900)	53.34 (2.100)

# Male Style B Press-Fit



## Series 8458 – 2 rows (2 x 32)

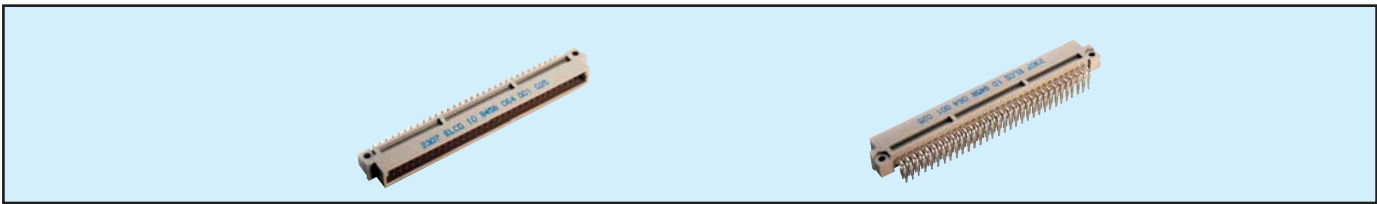

Contact Design and Termination Length	Number of Contacts	Loading Description	Part Number	
			Performance classes according to DIN 41612	
			II	I
for ≥ 2.4 mm PCB's 5.3 mm (Y) Right Angled	64	a + b fully loaded	10 8458 064 001 025	10 8458 064 001 049
	32	a loading only	10 8458 064 001 027	10 8458 064 001 051
	62 + 2	fully loaded + ground	10 8458 064 101 025	10 8458 064 101 049
for 1.6 mm PCB's 3.0 mm (Y) Right Angled	64	a + b fully loaded	10 8458 064 031 025	10 8458 064 031 049
	32	a loading only	10 8458 064 031 027	10 8458 064 031 051
	62 + 2	fully loaded + ground	10 8458 064 131 025	10 8458 064 131 049

NB: Alternative Prefix Variations Available: 12, please refer to Page 10.  
Additional Plating & Loading Variations: Please contact your local AVX sales office or distributor.

### LOADING DESCRIPTION

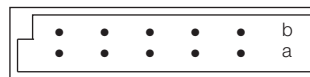

64 contacts, rows a + b fully loaded

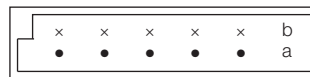

32 contacts, row a loading only

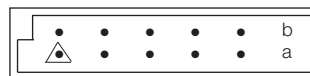

62 + 2 contacts, fully loaded with ground in A1 & A32

△ denotes ground pin

### DIMENSIONS

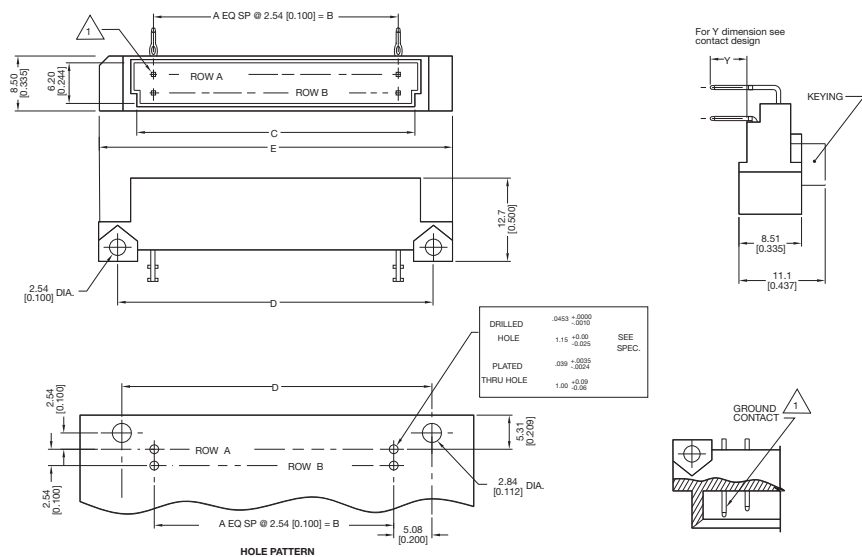

Assembly Tool: 06 8458 9261 00 000 (see page 67)

Unit: millimeters (inches)

No. Contact Positions	Contact Rows	A	B	C	D	E
64	2 (2 x 32)	31	78.74 (3.100)	85.19 (3.354)	88.90 (3.500)	93.98 (3.700)

# Female Style B Press-Fit



## Series 8458 – 2 rows (2 x 32)

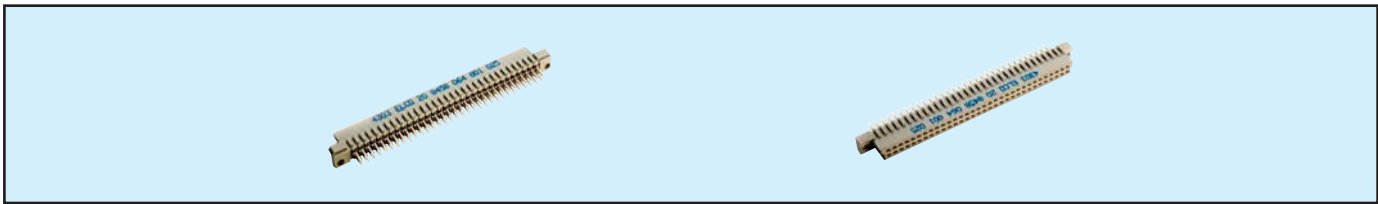

Contact Design and Termination Length	Number of Contacts	Loading Description	Part Number Performance classes according to DIN 41612	
			II	I
for ≥ 2.4 mm PCB's 0.6 x 0.6 mm Post Profile 5.3 mm (Y) Straight	64	a + b fully loaded	20 8458 064 001 025	20 8458 064 001 049
	32	a + b even loading	20 8458 064 001 007	20 8458 064 001 055
	32	a loading only	20 8458 064 001 027	20 8458 064 001 051
for ≥ 2.4 mm PCB's 0.6 x 0.6 mm Post Profile 9.3 mm (Y) Straight	64	a + b fully loaded	20 8458 064 002 025	20 8458 064 002 049
	32	a + b even loading	20 8458 064 002 007	20 8458 064 002 055
	32	a loading only	20 8458 064 002 027	20 8458 064 002 051
for ≥ 2.4 mm PCB's 0.6 x 0.6 mm Post Profile 16.2 mm (Y) Straight	64	a + b fully loaded	20 8458 064 003 025	20 8458 064 003 049
	32	a + b even loading	20 8458 064 003 007	20 8458 064 003 055
	32	a loading only	20 8458 064 003 027	20 8458 064 003 051
for ≥ 2.4 mm PCB's 0.6 x 0.6 mm Post Profile 23.2 mm (Y) Straight	64	a + b fully loaded	20 8458 064 004 025	20 8458 064 004 049
	32	a + b even loading	20 8458 064 004 007	20 8458 064 004 055
	32	a loading only	20 8458 064 004 027	20 8458 064 004 051
for ≥ 2.4 mm PCB's 0.6 x 0.6 mm Post Profile 13.2 mm (Y) Straight	64	a + b fully loaded	20 8458 064 005 025	20 8458 064 005 049
	32	a + b even loading	20 8458 064 005 007	20 8458 064 005 055
	32	a loading only	20 8458 064 005 027	20 8458 064 005 051
for ≥ 2.4 mm PCB's 0.6 x 0.6 mm Post Profile 12.0 mm (Y) Straight	64	a + b fully loaded	20 8458 064 009 025	20 8458 064 009 049
	32	a + b even loading	20 8458 064 009 007	20 8458 064 009 055
	32	a loading only	20 8458 064 009 027	20 8458 064 009 051
for ≥ 2.4 mm PCB's 0.6 x 0.6 mm Post Profile 20.3 mm (Y) Straight	64	a + b fully loaded	20 8458 064 010 025	20 8458 064 010 049
	32	a + b even loading	20 8458 064 010 007	20 8458 064 010 055
	32	a loading only	20 8458 064 010 027	20 8458 064 010 051
for ≥ 2.4 mm PCB's 0.6 x 0.6 mm Post Profile 17.0 mm Straight	64	a + b fully loaded	20 8458 064 012 025	20 8458 064 012 049
	32	a + b even loading	20 8458 064 012 007	20 8458 064 012 055
	32	a loading only	20 8458 064 012 027	20 8458 064 012 051
for 1.6 mm PCB's 0.6 x 0.6 mm Post Profile 3.0 mm (Y) Straight	64	a + b fully loaded	20 8458 064 031 025	20 8458 064 031 049
	32	a + b even loading	20 8458 064 031 007	20 8458 064 031 055
	32	a loading only	20 8458 064 031 027	20 8458 064 031 051

NB: Alternative Prefix Variations Available: 21, 22 & 23, please refer to Page 10.

Additional Plating & Loading Variations: Please contact your local AVX sales office or distributor.

Installed using Flat Rock method (see page 66)

### LOADING DESCRIPTION



64 contacts, rows a + b fully loaded

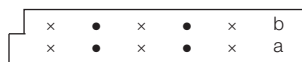

32 contacts, rows a + b even loading



32 contacts, row a loading only

### DIMENSIONS

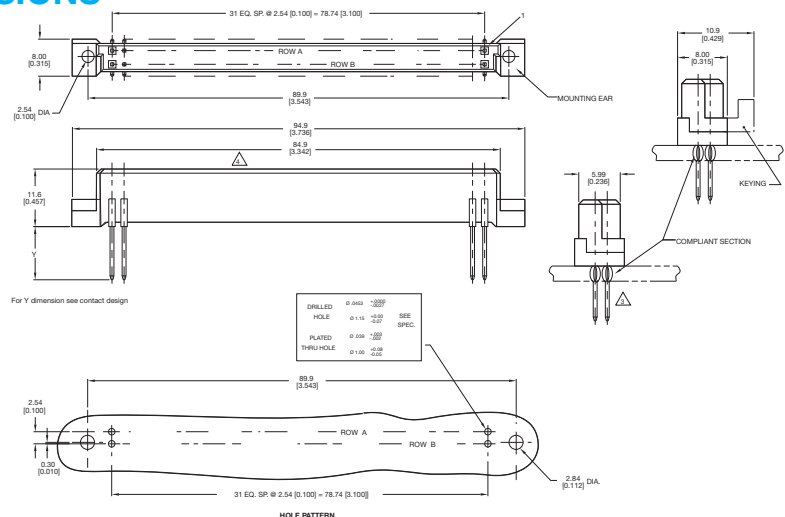

# Male Style 1/3 C Press-Fit



## Series 8458 – 3 rows (3 x 10)

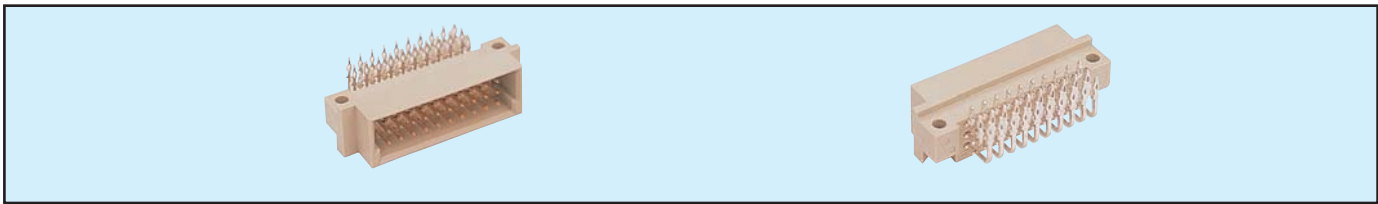

Contact Design and Termination Length	Number of Contacts	Loading Description	Part Number Performance classes according to DIN 41612	
			II	I
for ≥ 2.4 mm PCB's 5.3 mm (Y) (0.6" x 0.6") Right Angled	30	a + b + c fully loaded	10 8458 030 001 025	10 8458 030 001 049
	20	a + c fully loaded	10 8458 030 001 026	10 8458 030 001 050
	28 + 2	fully loaded + ground	10 8458 030 101 025	10 8458 030 101 049
for 1.6 mm PCB's 3.0 mm (Y) (0.6" x 0.6") Right Angled	30	a + b + c fully loaded	10 8458 030 031 025	10 8458 030 031 049
	20	a + c fully loaded	10 8458 030 031 026	10 8458 030 031 050
	28 + 2	fully loaded + ground	10 8458 030 131 025	10 8458 030 131 049

NB: Alternative Prefix Variations Available: 12, please refer to Page 10.

Additional Plating & Loading Variations: Please contact your local AVX sales office or distributor.

### LOADING DESCRIPTION

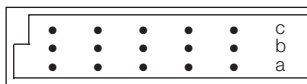

30 contacts, rows a + b + c fully loaded

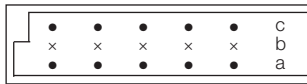

20 contacts, rows a + c fully loaded

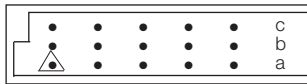

28 + 2 contacts, fully loaded with ground in A1 & A10

△ denotes ground pin

### DIMENSIONS

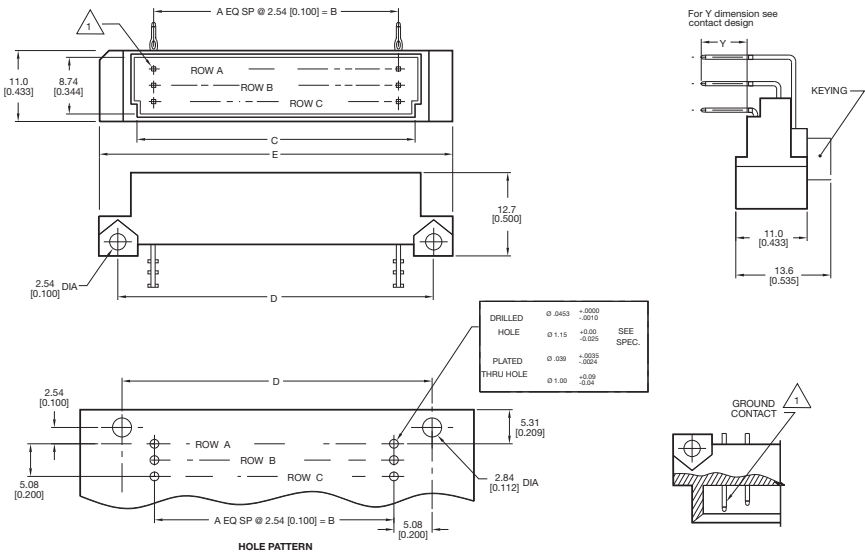

Assembly Tool: 06 8458 9241 00 000 (see page 67)

Unit: millimeters (inches)

No. Contact Positions	Contact Rows	A	B	C	D	E
30	3 (3 x 10)	9	22.86 (0.900)	29.41 (1.158)	33.02 (1.300)	38.02 (1.497)

# Female Style 1/3 C Press-Fit



## Series 8458 – 3 rows (3 x 10)

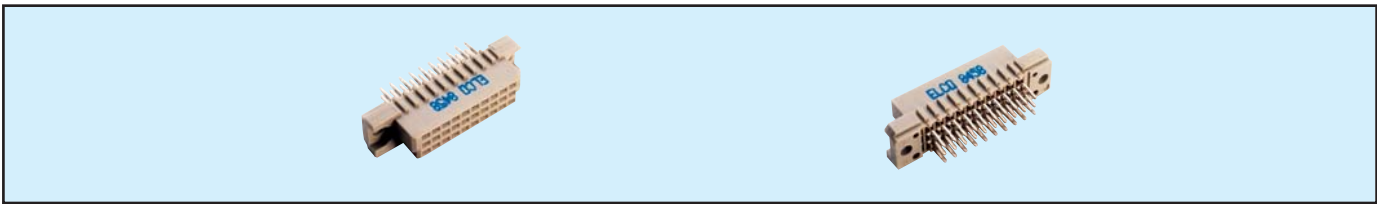

Contact Design and Termination Length	Number of Contacts	Loading Description	Part Number Performance classes according to DIN 41612	
			II	I
<b>for ≥ 2.4 mm PCB's</b> 0.6 x 0.6 mm Post Profile 5.3 mm (Y) Straight	30	a + b + c fully loaded	20 8458 030 001 025	20 8458 030 001 049
	20	a + c fully loaded	20 8458 030 001 026	20 8458 030 001 050
<b>for ≥ 2.4 mm PCB's</b> 0.6 x 0.6 mm Post Profile 9.3 mm (Y) Straight	30	a + b + c fully loaded	20 8458 030 002 025	20 8458 030 002 049
	20	a + c fully loaded	20 8458 030 002 026	20 8458 030 002 050
<b>for ≥ 2.4 mm PCB's</b> 0.6 x 0.6 mm Post Profile 16.2 mm (Y) Straight	30	a + b + c fully loaded	20 8458 030 003 025	20 8458 030 003 049
	20	a + c fully loaded	20 8458 030 003 026	20 8458 030 003 050
<b>for ≥ 2.4 mm PCB's</b> 0.6 x 0.6 mm Post Profile 23.2 mm (Y) Straight	30	a + b + c fully loaded	20 8458 030 004 025	20 8458 030 004 049
	20	a + c fully loaded	20 8458 030 004 026	20 8458 030 004 050
<b>for ≥ 2.4 mm PCB's</b> 0.6 x 0.6 mm Post Profile 13.2 mm (Y) Straight	30	a + b + c fully loaded	20 8458 030 005 025	20 8458 030 005 049
	20	a + c fully loaded	20 8458 030 005 026	20 8458 030 005 050
<b>for ≥ 2.4 mm PCB's</b> 0.6 x 0.6 mm Post Profile 12.0 mm (Y) Straight	30	a + b + c fully loaded	20 8458 030 009 025	20 8458 030 009 049
	20	a + c fully loaded	20 8458 030 009 026	20 8458 030 009 050
<b>for ≥ 2.4 mm PCB's</b> 0.6 x 0.6 mm Post Profile 20.3 mm (Y) Straight	30	a + b + c fully loaded	20 8458 030 010 025	20 8458 030 010 049
	20	a + c fully loaded	20 8458 030 010 026	20 8458 030 010 050
<b>for ≥ 2.4 mm PCB's</b> 0.6 x 0.6 mm Post Profile 17.0 mm (Y) Straight	30	a + b + c fully loaded	20 8458 030 012 025	20 8458 030 012 049
	20	a + c fully loaded	20 8458 030 012 026	20 8458 030 012 050
<b>for 1.6 mm PCB's</b> 0.6 x 0.6 mm Post Profile 3.0 mm (Y) Straight	30	a + b + c fully loaded	20 8458 030 031 025	20 8458 030 031 049
	20	a + c fully loaded	20 8458 030 031 026	20 8458 030 031 050

NB: Alternative Prefix Variations Available: 21, 22 & 23, please refer to Page 10.

Additional Plating & Loading Variations: Please contact your local AVX sales office or distributor.

Installed using Flat Rock method (see page 66)

### LOADING DESCRIPTION

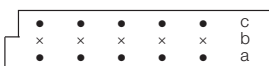
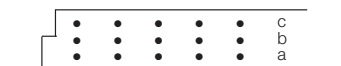

### DIMENSIONS

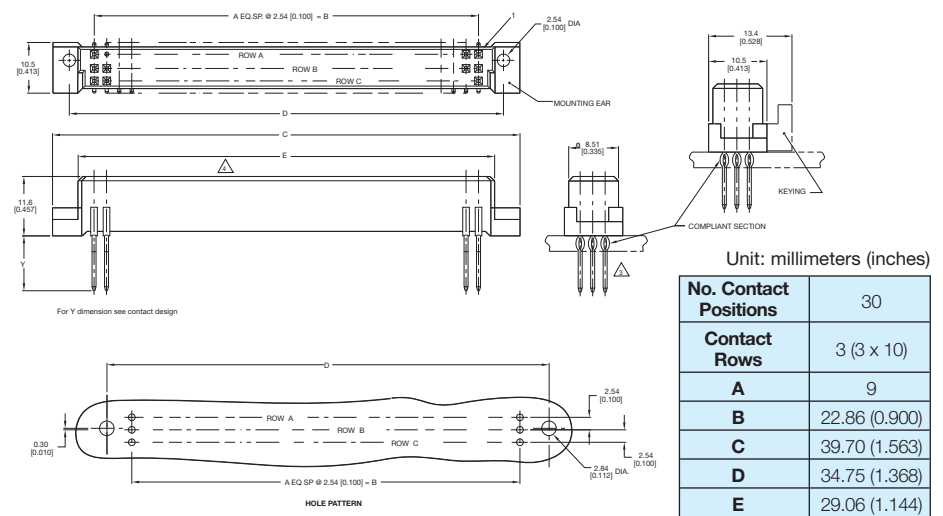

# Male Style 1/2 C Press-Fit

## Series 8458 – 3 rows (3 x 16)

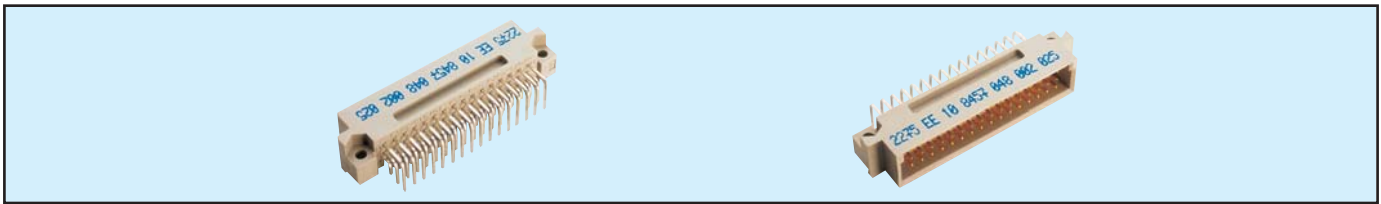

Contact Design and Termination Length	Number of Contacts	Loading Description	Part Number Performance classes according to DIN 41612	
			II	I
for ≥ 2.4 mm PCB's  0.6 x 0.6 mm Post Profile 5.3 mm (Y) Right Angled	48	a + b + c fully loaded	10 8458 048 001 025	10 8458 048 001 049
	32	a + c fully loaded	10 8458 048 001 026	10 8458 048 001 050
	16	a + c even loading	10 8458 048 001 033	10 8458 048 001 057
	16	a loading only	10 8458 048 001 027	10 8458 048 001 051
	46 + 2	fully loaded + ground	10 8458 048 101 025	10 8458 048 101 049
for 1.6 mm PCB's  0.6 x 0.6 mm Post Profile 3.0 mm (Y) Right Angled	48	a + b + c fully loaded	10 8458 048 031 025	10 8458 048 031 049
	32	a + c fully loaded	10 8458 048 031 026	10 8458 048 031 050
	16	a + c even loading	10 8458 048 031 033	10 8458 048 031 057
	16	a loading only	10 8458 048 031 027	10 8458 048 031 051
	46 + 2	fully loaded + ground	10 8458 048 131 025	10 8458 048 131 049

NB: Alternative Prefix Variations Available: please refer to Page 10.  
Additional Plating & Loading Variations: Please contact your local AVX sales office or distributor.

### LOADING DESCRIPTION

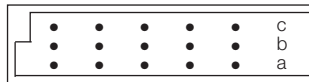

48 contacts, rows a + b + c fully loaded

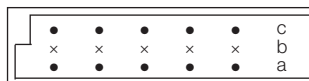

32 contacts, rows a + c fully loaded

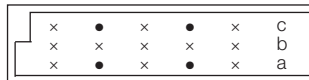

16 contacts, rows a + c even loading

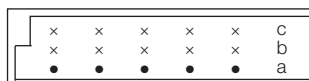

16 contacts, rows a loading only

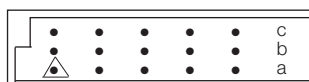

46 + 2 contacts, fully loaded with ground in A1 & A16

△ denotes ground pin

### DIMENSIONS

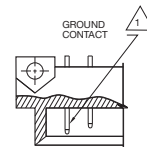
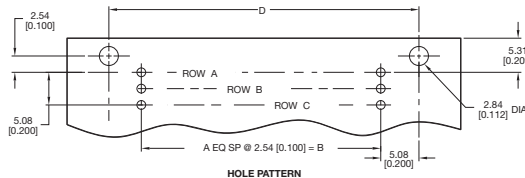
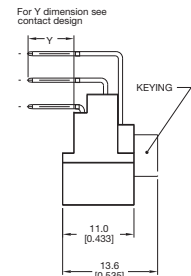
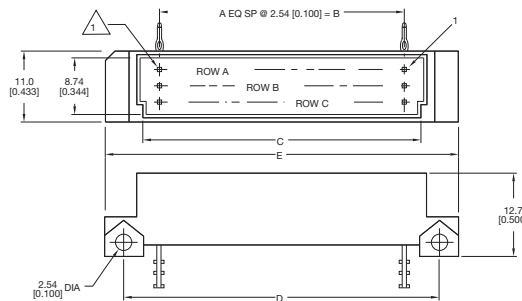

Assembly Tool: 06 8458 9231 00 000 (see page 67)

Unit: millimeters (inches)

No. Contact Positions	Contact Rows	A	B	C	D	E
48	3 (3 x 16)	15	38.10 (1.500)	44.70 (1.760)	48.26 (1.900)	53.90 (2.122)

# Female Style 1/2 C Press-Fit



## Series 8458 – 3 rows (3 x 16)



Contact Design and Termination Length	Number of Contacts	Loading Description	Part Number Performance classes according to DIN 41612	
			II	I
<b>for ≥ 2.4 mm PCB's</b> 0.6 x 0.6 mm Post Profile 5.3 mm (Y) Straight	48	a + b + c fully loaded	20 8458 048 001 025	20 8458 048 001 049
	32	a + c fully loaded	20 8458 048 001 026	20 8458 048 001 050
<b>for ≥ 2.4 mm PCB's</b> 0.6 x 0.6 mm Post Profile 9.3 mm (Y) Straight	48	a + b + c fully loaded	20 8458 048 002 025	20 8458 048 002 049
	32	a + c fully loaded	20 8458 048 002 026	20 8458 048 002 050
<b>for ≥ 2.4 mm PCB's</b> 0.6 x 0.6 mm Post Profile 16.2 mm (Y) Straight	48	a + b + c fully loaded	20 8458 048 003 025	20 8458 048 003 049
	32	a + c fully loaded	20 8458 048 003 026	20 8458 048 003 050
<b>for ≥ 2.4 mm PCB's</b> 0.6 x 0.6 mm Post Profile 23.2 mm (Y) Straight	48	a + b + c fully loaded	20 8458 048 004 025	20 8458 048 004 049
	32	a + c fully loaded	20 8458 048 004 026	20 8458 048 004 050
<b>for ≥ 2.4 mm PCB's</b> 0.6 x 0.6 mm Post Profile 13.2 mm (Y) Straight	48	a + b + c fully loaded	20 8458 048 005 025	20 8458 048 005 049
	32	a + c fully loaded	20 8458 048 005 026	20 8458 048 005 050
<b>for ≥ 2.4 mm PCB's</b> 0.6 x 0.6 mm Post Profile 12.0 mm (Y) Straight	48	a + b + c fully loaded	20 8458 048 009 025	20 8458 048 009 049
	32	a + c fully loaded	20 8458 048 009 026	20 8458 048 009 050
<b>for ≥ 2.4 mm PCB's</b> 0.6 x 0.6 mm Post Profile 20.3 mm (Y) Straight	48	a + b + c fully loaded	20 8458 048 010 025	20 8458 048 010 049
	32	a + c fully loaded	20 8458 048 010 026	20 8458 048 010 050
<b>for ≥ 2.4 mm PCB's</b> 0.6 x 0.6 mm Post Profile 17.0 mm (Y) Straight	48	a + b + c fully loaded	20 8458 048 012 025	20 8458 048 012 049
	32	a + c fully loaded	20 8458 048 012 026	20 8458 048 012 050
<b>for 1.6 mm PCB's</b> 0.6 x 0.6 mm Post Profile 3.0 mm (Y) Straight	48	a + b + c fully loaded	20 8458 048 031 025	20 8458 048 031 049
	32	a + c fully loaded	20 8458 048 031 026	20 8458 048 031 050

NB: Alternative Prefix Variations Available: 21, 22 & 23, please refer to Page 10.

Additional Plating & Loading Variations: Please contact your local AVX sales office or distributor.

Installed using Flat Rock method (see page 66)

### LOADING DESCRIPTION

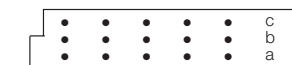

48 contacts, rows a + b + c fully loaded

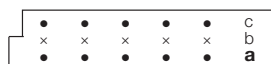

32 contacts, rows a + c fully loaded

### DIMENSIONS

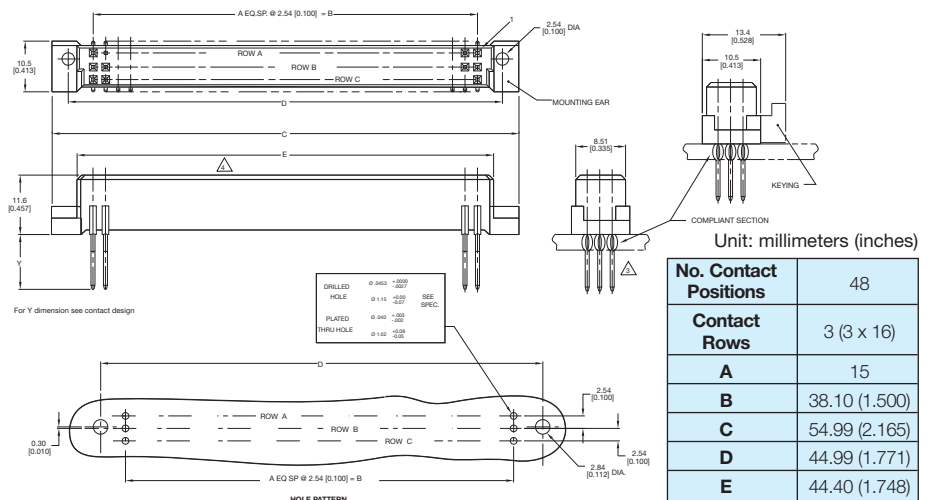



# Male Style C Press-Fit

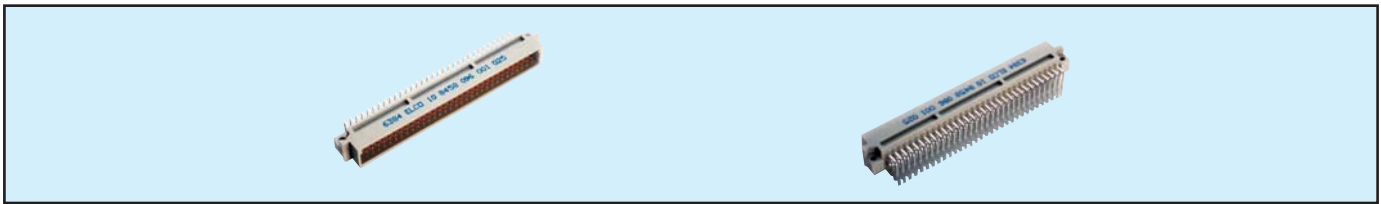

## Series 8458 – 3 rows (3 x 32)



Contact Design and Termination Length	Number of Contacts	Loading Description	Part Number Performance classes according to DIN 41612	
			II	I
for $\geq 2.4$ mm PCB's  0.6 x 0.6 mm Post Profile 5.3 mm (Y) Right Angled	96	a + b + c fully loaded	10 8458 096 001 025	10 8458 096 001 049
	64	a + c fully loaded	10 8458 096 001 026	10 8458 096 001 050
	32	a + c even loading	10 8458 096 001 033	10 8458 096 001 057
	32	a loading only	10 8458 096 001 027	10 8458 096 001 051
	94 + 2	fully loaded + ground	10 8458 096 101 025	10 8458 096 101 049
for 1.6 mm PCB's  0.6 x 0.6 mm Post Profile 3.0 mm (Y) Right Angled	96	a + b + c fully loaded	10 8458 096 031 025	10 8458 096 031 049
	64	a + c fully loaded	10 8458 096 031 026	10 8458 096 031 050
	32	a + c even loading	10 8458 096 031 033	10 8458 096 031 057
	32	a loading only	10 8458 096 031 027	10 8458 096 031 051
	94 + 2	fully loaded + ground	10 8458 096 131 025	10 8458 096 131 049

NB: Alternative Prefix Variations Available: 12, please refer to Page 10.  
 Additional Plating & Loading Variations: Please contact your local AVX sales office or distributor.

### LOADING DESCRIPTION

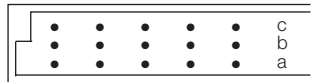

96 contacts, rows a + b + c fully loaded

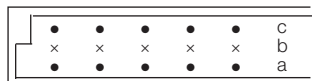

64 contacts, rows a + c fully loaded

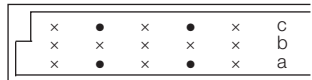

32 contacts, rows a + c even loading

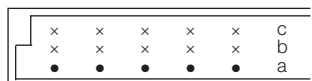

32 contacts, row a loading only

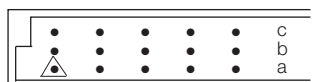

94 + 2 contacts, fully loaded with ground in A1 + A32

△ denotes ground pin

### DIMENSIONS

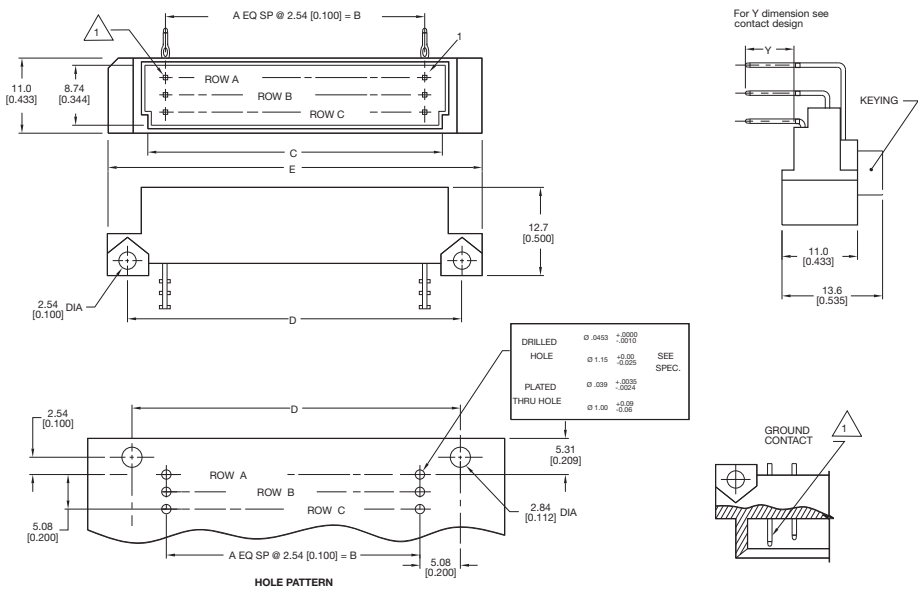

Assembly Tool: 06 8458 9271 00 000 (see page 67)

Unit: millimeters (inches)

No. Contact Positions	Contact Rows	A	B	C	D	E
96	3 (3 x 32)	31	78.74 (3.100)	85.29 (3.358)	88.90 (3.500)	93.90 (3.697)



# Female Style C Press-Fit



## Series 8458 – 3 rows (3 x 32)



Contact Design and Termination Length	Number of Contacts	Loading Description	Part Number Performance classes according to DIN 41612	
			II	I
<b>for ≥ 2.4 mm PCB's</b>				
0.6 x 0.6 mm Post Profile	96	a + b + c fully loaded	20 8458 096 001 025	20 8458 096 001 049
5.3 mm (Y) Straight	64	a + c fully loaded	20 8458 096 001 026	20 8458 096 001 050
<b>for ≥ 2.4 mm PCB's</b>				
0.6 x 0.6 mm Post Profile	96	a + b + c fully loaded	20 8458 096 002 025	20 8458 096 002 049
9.3 mm (Y) Straight	64	a + c fully loaded	20 8458 096 002 026	20 8458 096 002 050
<b>for ≥ 2.4 mm PCB's</b>				
0.6 x 0.6 mm Post Profile	96	a + b + c fully loaded	20 8458 096 003 025	20 8458 096 003 049
16.2 mm (Y) Straight	64	a + c fully loaded	20 8458 096 003 026	20 8458 096 003 050
<b>for ≥ 2.4 mm PCB's</b>				
0.6 x 0.6 mm Post Profile	96	a + b + c fully loaded	20 8458 096 004 025	20 8458 096 004 049
23.2 mm (Y) Straight	64	a + c fully loaded	20 8458 096 004 026	20 8458 096 004 050
<b>for ≥ 2.4 mm PCB's</b>				
0.6 x 0.6 mm Post Profile	96	a + b + c fully loaded	20 8458 096 005 025	20 8458 096 005 049
13.2 mm (Y) Straight	64	a + c fully loaded	20 8458 096 005 026	20 8458 096 005 050
<b>for ≥ 2.4 mm PCB's</b>				
0.6 x 0.6 mm Post Profile	96	a + b + c fully loaded	20 8458 096 009 025	20 8458 096 009 049
12.0 mm (Y) Straight	64	a + c fully loaded	20 8458 096 009 026	20 8458 096 009 050
<b>for ≥ 2.4 mm PCB's</b>				
0.6 x 0.6 mm Post Profile	96	a + b + c fully loaded	20 8458 096 010 025	20 8458 096 010 049
20.3 mm (Y) Straight	64	a + c fully loaded	20 8458 096 010 026	20 8458 096 010 050
<b>for ≥ 2.4 mm PCB's</b>				
0.6 x 0.6 mm Post Profile	96	a + b + c fully loaded	20 8458 096 012 025	20 8458 096 012 049
17.0 mm (Y) Straight	64	a + c fully loaded	20 8458 096 012 026	20 8458 096 012 050
<b>for 1.6 mm PCB's</b>				
0.6 x 0.6 mm Post Profile	96	a + b + c fully loaded	20 8458 096 031 025	20 8458 096 031 049
3.0 mm (Y) Straight	64	a + c fully loaded	20 8458 096 031 026	20 8458 096 031 050

NB: Alternative Prefix Variations Available: 21, 22 & 23, please refer to Page 10.

Additional Plating & Loading Variations: Please contact your local AVX sales office or distributor.

Installed using Flat Rock method (see page 66)

### LOADING DESCRIPTION



96 contacts, rows a + b + c fully loaded

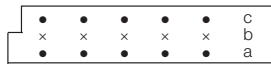

64 contacts, rows a + c fully loaded

### DIMENSIONS

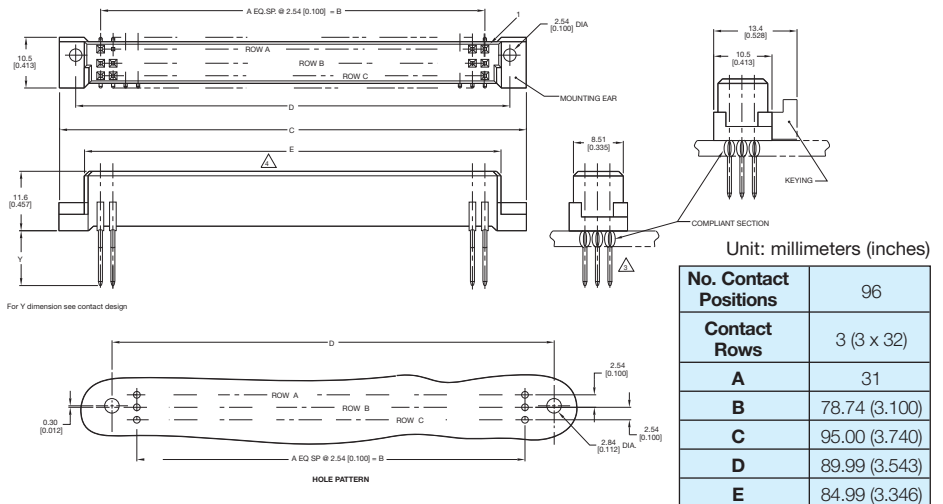

# Female Style C Expanded Press-Fit



## Series 8458 – 4 rows (4 x 32)

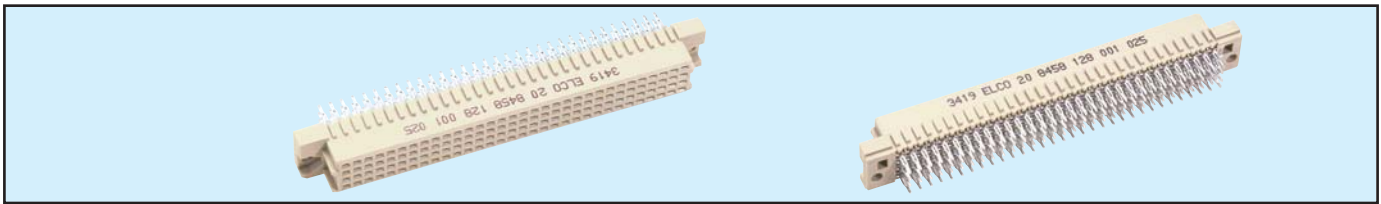

Contact Design and Termination Length	Number of Contacts	Loading Description	Part Number Performance classes according to DIN 41612	
			II	I
<b>for ≥ 2.4 mm PCB's</b> 0.6 x 0.6 mm Post Profile 5.3 mm (Y) Straight	128	a + b + c + d fully loaded	20 8458 128 001 025	20 8458 128 001 049
<b>for ≥ 2.4 mm PCB's</b> 0.6 x 0.6 mm Post Profile 9.3 mm (Y) Straight	128	a + b + c + d fully loaded	20 8458 128 002 025	20 8458 128 002 049
<b>for ≥ 2.4 mm PCB's</b> 0.6 x 0.6 mm Post Profile 16.2 mm (Y) Straight	128	a + b + c + d fully loaded	20 8458 128 003 025	20 8458 128 003 049
<b>for ≥ 2.4 mm PCB's</b> 0.6 x 0.6 mm Post Profile 23.2 mm (Y) Straight	128	a + b + c + d fully loaded	20 8458 128 004 025	20 8458 128 004 049
<b>for ≥ 2.4 mm PCB's</b> 0.6 x 0.6 mm Post Profile 13.2 mm (Y) Straight	128	a + b + c + d fully loaded	20 8458 128 005 025	20 8458 128 005 049
<b>for ≥ 2.4 mm PCB's</b> 0.6 x 0.6 mm Post Profile 12.0 mm (Y) Straight	128	a + b + c + d fully loaded	20 8458 128 009 025	20 8458 128 009 049
<b>for ≥ 2.4 mm PCB's</b> 0.6 x 0.6 mm Post Profile 20.3 mm (Y) Straight	128	a + b + c + d fully loaded	20 8458 128 010 025	20 8458 128 010 049
<b>for ≥ 2.4 mm PCB's</b> 0.6 x 0.6 mm Post Profile 17.0 mm (Y) Straight	128	a + b + c + d fully loaded	20 8458 128 012 025	20 8458 128 012 049
<b>for 1.6 mm PCB's</b> 0.6 x 0.6 mm Post Profile 3.0 mm (Y) Straight	128	a + b + c + d fully loaded	20 8458 128 031 025	20 8458 128 031 049

NB: Alternative Prefix Variations Available: 21, 22 & 23, please refer to Page 10.  
 Additional Plating & Loading Variations: Please contact your local AVX sales office or distributor.

Installed using Flat Rock method (see page 66)

### LOADING DESCRIPTION



128 contacts,  
rows a + b + c + d fully loaded

### DIMENSIONS

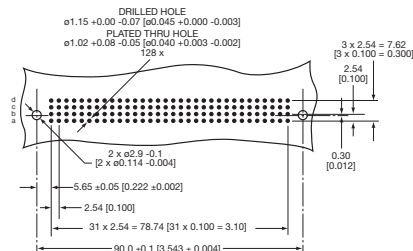

HOLE PATTERN

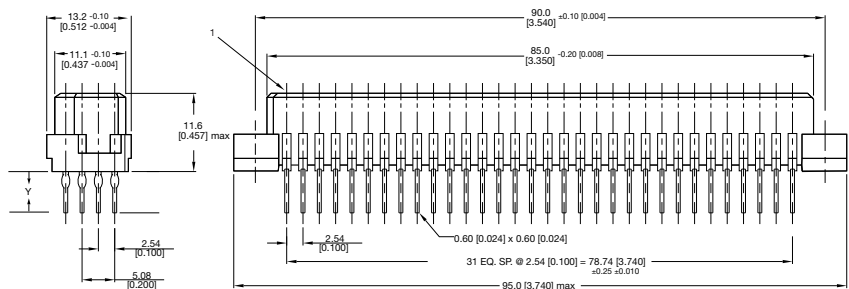

Unit: millimeters (inches)

No. Contact Positions	Contact Rows	A	B	C	D	E	F	G
128	4 (4 x 32)	31	78.74 (3.100)	95.00 (3.740)	90.00 (3.543)	85.00 (3.346)	11.00 (0.433)	13.10 (0.516)

# Female Style C Expanded Press-Fit



## Series 8458 – 5 rows (5 x 32)

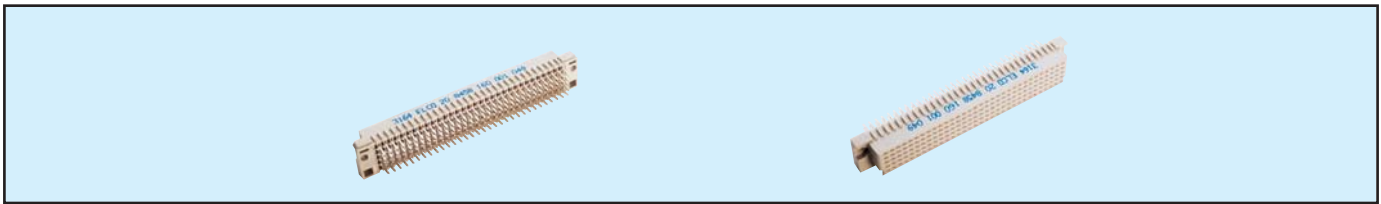

Contact Design and Termination Length	Number of Contacts	Loading Description	Part Number Performance classes according to DIN 41612	
			II	I
<b>for ≥ 2.4 mm PCB's</b> 0.6 x 0.6 mm Post Profile 5.3 mm (Y) Straight	160	a + b + c + d + e fully loaded	20 8458 160 001 025	20 8458 160 001 049
<b>for ≥ 2.4 mm PCB's</b> 0.6 x 0.6 mm Post Profile 9.3 mm (Y) Straight	160	a + b + c + d + e fully loaded	20 8458 160 002 025	20 8458 160 002 049
<b>for ≥ 2.4 mm PCB's</b> 0.6 x 0.6 mm Post Profile 16.2 mm (Y) Straight	160	a + b + c + d + e fully loaded	20 8458 160 003 025	20 8458 160 003 049
<b>for ≥ 2.4 mm PCB's</b> 0.6 x 0.6 mm Post Profile 23.2 mm (Y) Straight	160	a + b + c + d + e fully loaded	20 8458 160 004 025	20 8458 160 004 049
<b>for ≥ 2.4 mm PCB's</b> 0.6 x 0.6 mm Post Profile 13.2 mm (Y) Straight	160	a + b + c + d + e fully loaded	20 8458 160 005 025	20 8458 160 005 049
<b>for ≥ 2.4 mm PCB's</b> 0.6 x 0.6 mm Post Profile 12.0 mm (Y) Straight	160	a + b + c + d + e fully loaded	20 8458 160 009 025	20 8458 160 009 049
<b>for ≥ 2.4 mm PCB's</b> 0.6 x 0.6 mm Post Profile 20.3 mm (Y) Straight	160	a + b + c + d + e fully loaded	20 8458 160 010 025	20 8458 160 010 049
<b>for ≥ 2.4 mm PCB's</b> 0.6 x 0.6 mm Post Profile 17.0 mm (Y) Straight	160	a + b + c + d + e fully loaded	20 8458 160 012 025	20 8458 160 012 049
<b>for 1.6 mm PCB's</b> 0.6 x 0.6 mm Post Profile 3.0 mm (Y) Straight	160	a + b + c + d + e fully loaded	20 8458 160 031 025	20 8458 160 031 049

NB: Alternative Prefix Variations Available: 21, 22 & 23, please refer to Page 10.

Additional Plating & Loading Variations: Please contact your local AVX sales office or distributor.

Installed using Flat Rock method (see page 66)

### LOADING DESCRIPTION

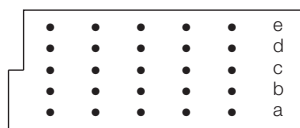

160 contacts,  
rows a + b + c + d + e fully loaded

### DIMENSIONS

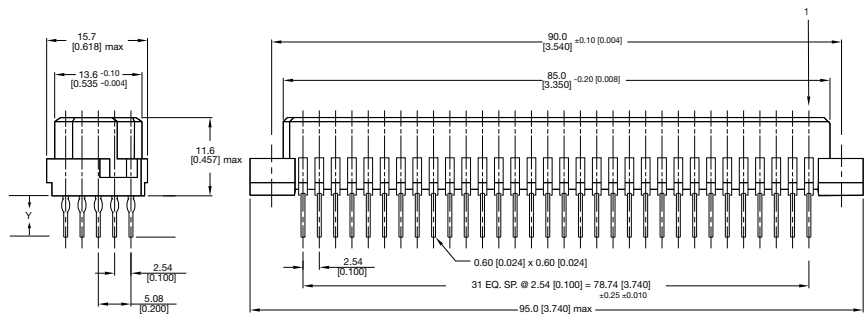

Unit: millimeters (inches)

No. Contact Positions	Contact Rows	A	B	C	D	E	F	G
160	5 (5 x 32)	31	78.74 (3.100)	95.00 (3.740)	90.00 (3.543)	85.00 (3.346)	11.00 (0.433)	13.10 (0.516)

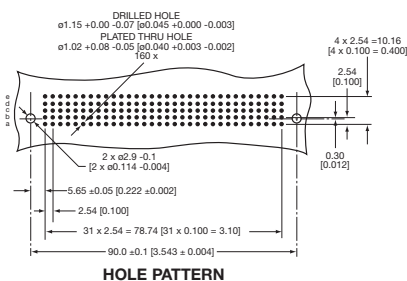

HOLE PATTERN

单击下面可查看定价，库存，交付和生命周期等信息

[>>AVX](#)