

RF/Microwave Capacitors

RF/Microwave Multilayer Capacitors (MLC)

600S Ultra-Low ESR, High Q, NPO Capacitors

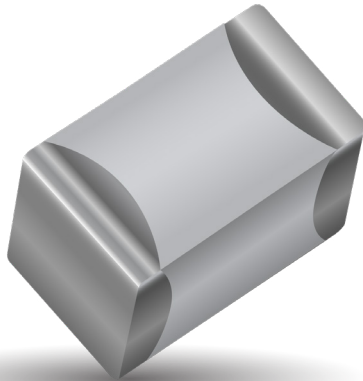

FEATURES

- Lowest ESR in Class
- Highest Working Voltage in Class - 250 V
- Standard EIA Size: 0603
- Laser Marking (Optional)
- High Self-Resonance Frequencies

600 SERIES OVERVIEW

Series	Case Size	EIA Case Size
600	L	0402
600	S	0603
600	F	0805

APPLICATIONS

- Cellular Base Stations
- Broadband Wireless Services
- Satellite Communications
- Subscriber-based Wireless Devices
- WiFi (802.11)
- Public Safety Radio

CIRCUIT APPLICATIONS

- Filter Networks
- High Q Frequency Sources
- Matching Networks
- Tuning, Coupling, Bypass and DC Blocking

ELECTRICAL SPECIFICATIONS

Capacitance	0.1 to 100 pF
Tolerances	See Cap Value Chart
Working Voltage (WVDC)	250 V
Quality Factor (Q)	> 2000 @ 1 MHz
Operating Temperature Range	-55°C to +125°C (no derating of working voltage)
Temperature Coefficient of Capacitance (TCC)	0 ± 30 ppm/°C, -55°C to +125° 10 ⁵ MΩ min. at +25°C at rated WVDC 10 ⁴ MΩ min. at +125°C at rated WVDC
Dielectric Withstanding Voltage (DWV)	2.5 x WVDC for 5 seconds
Aging	None
Piezo Effects	None

PACKAGING OPTIONS



Tape & Reel



Vertical Orientation Tape & Reel



ENVIRONMENTAL CHARACTERISTICS

Thermal Shock	5 Cycles, -55°C to 125°C
Moisture Resistance	Mil-STD-202, Method 106
Life Test	2000 hours at 125°C at 2X WVDC
Solderability	Solder Coverage > 90% of end termination
Terminal Strength	4 lbs. typ., 2 lb. min.
Military Approval	DSCC Drawing Number 05002

RF/Microwave Capacitors

RF/Microwave Multilayer Capacitors (MLC)

600S Ultra-Low ESR, High Q, NPO Capacitors



CAPACITANCE VALUES

Value (pF)	Cap Code	Marking	Tolerances	Value (pF)	Cap Code	Marking	Tolerances	Value (pF)	Cap Code	Marking	Tolerances
0.1	0R1	A9	A, B	2.7	2R7	L0	A, B, C, D	20	200	H1	F, G, J, K, M
0.2	0R2	H9	A, B	3.0	3R0	M0	A, B, C, D	22	220	J1	F, G, J, K, M
0.3	0R3	M9	A, B, C	3.3	3R3	N0	A, B, C, D	24	240	K1	F, G, J, K, M
0.4	0R4	d9	A, B, C	3.6	3R6	P0	A, B, C, D	27	270	L1	F, G, J, K, M
0.5	0R5	f9	A, B, C	3.9	3R9	Q0	A, B, C, D	30	300	M1	F, G, J, K, M
0.6	0R6	m9	A, B, C	4.3	4R3	R0	A, B, C, D	33	330	N1	F, G, J, K, M
0.7	0R7	n9	A, B, C	4.7	4R7	S0	A, B, C, D	36	360	P1	F, G, J, K, M
0.8	0R8	t9	A, B, C	5.1	5R1	T0	A, B, C, D	39	390	Q1	F, G, J, K, M
0.9	0R9	y9	A, B, C	5.6	5R6	U0	A, B, C, D	43	430	R1	F, G, J, K, M
1.0	1R0	A0	A, B, C, D	6.2	6R2	V0	A, B, C, D	47	470	S1	F, G, J, K, M
1.1	1R1	B0	A, B, C, D	6.8	6R8	W0	B, C, J, K	51	510	T1	F, G, J, K, M
1.2	1R2	C0	A, B, C, D	7.5	7R5	X0	B, C, J, K	56	560	U1	F, G, J, K, M
1.3	1R3	D0	A, B, C, D	8.2	8R2	Y0	B, C, J, K	62	620	V1	F, G, J, K, M
1.5	1R5	E0	A, B, C, D	9.1	9R1	Z0	B, C, J, K	68	680	W1	F, G, J, K, M
1.6	1R6	F0	A, B, C, D	10	100	A1	F, G, J, K, M	75	750	X1	F, G, J, K, M
1.8	1R8	G0	A, B, C, D	11	110	B1	F, G, J, K, M	82	820	Y1	F, G, J, K, M
2.0	2R0	H0	A, B, C, D	12	120	C1	F, G, J, K, M	91	910	Z1	F, G, J, K, M
2.2	2R2	J0	A, B, C, D	15	150	E1	F, G, J, K, M	100	101	A2	F, G, J, K, M
2.4	2R4	K0	A, B, C, D	18	180	G1	F, G, J, K, M				

HOW TO ORDER

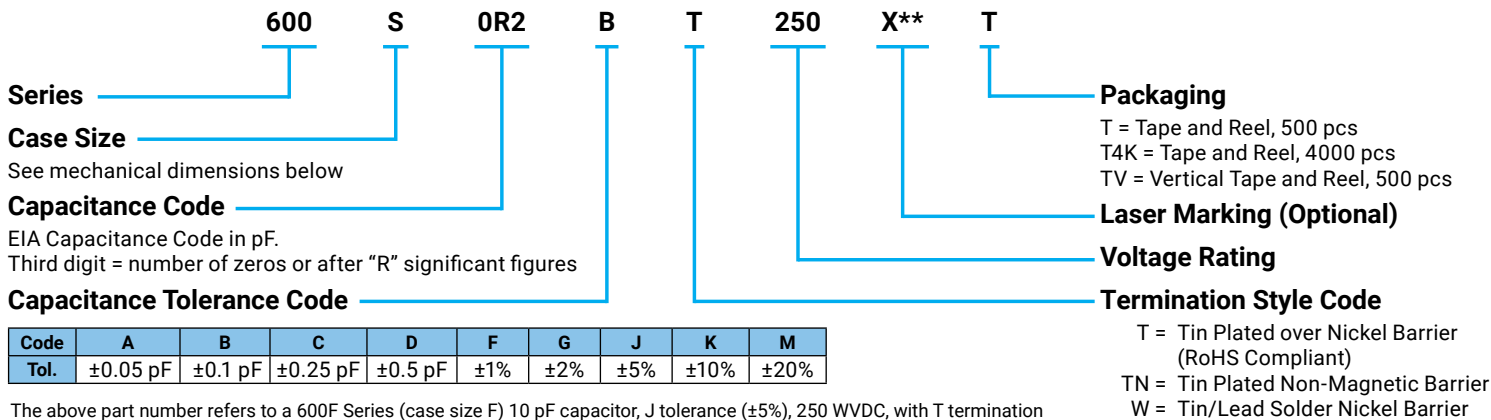

The above part number refers to a 600F Series (case size F) 10 pF capacitor, J tolerance (±5%), 250 WVDC, with T termination (Tin Plated over Nickel Barrier, RoHS Compliant), Laser Marking and Tape and Reel packaging.

**Laser Marking is optional

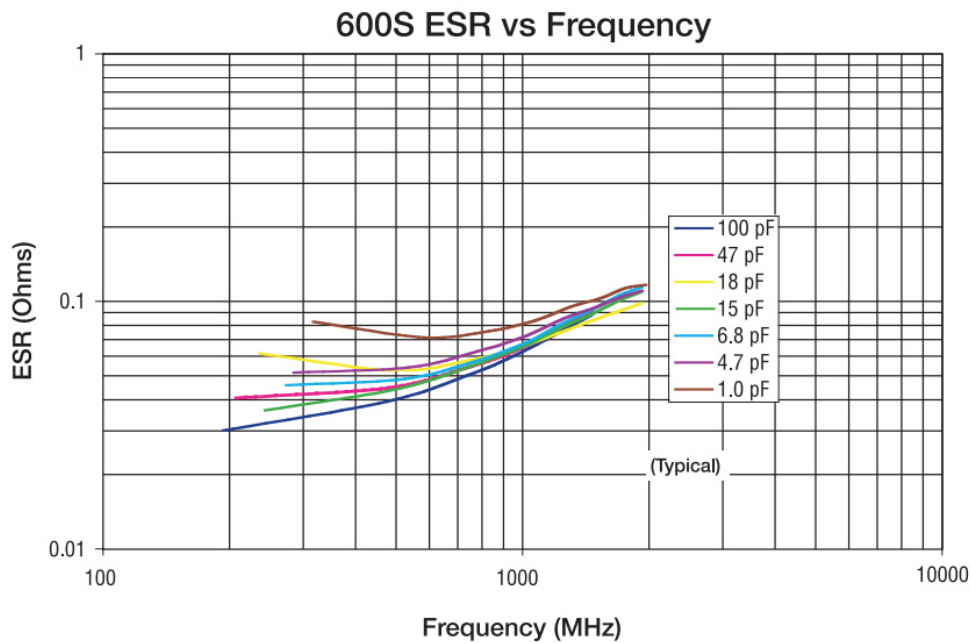
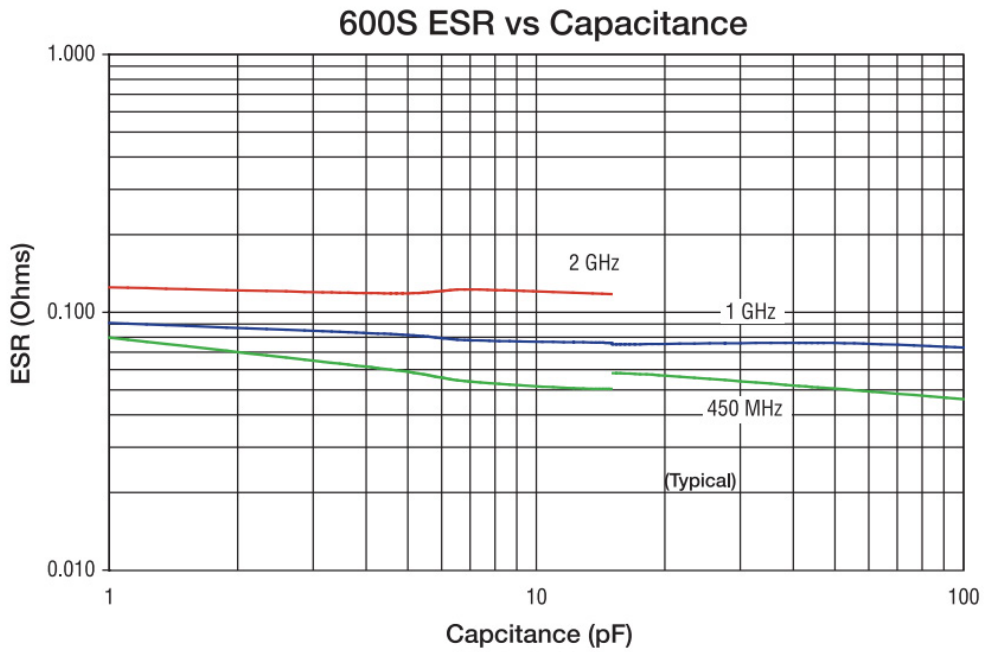

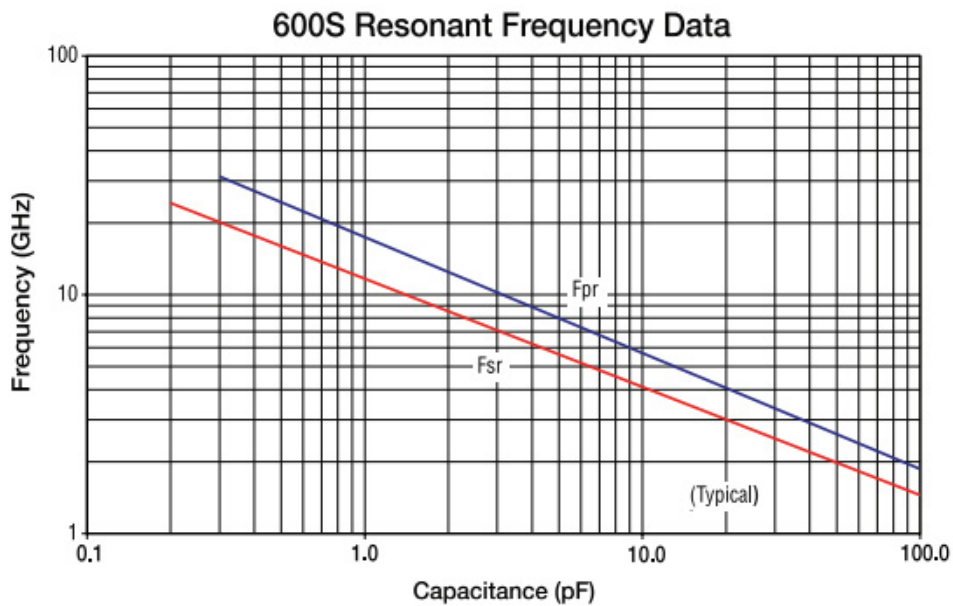
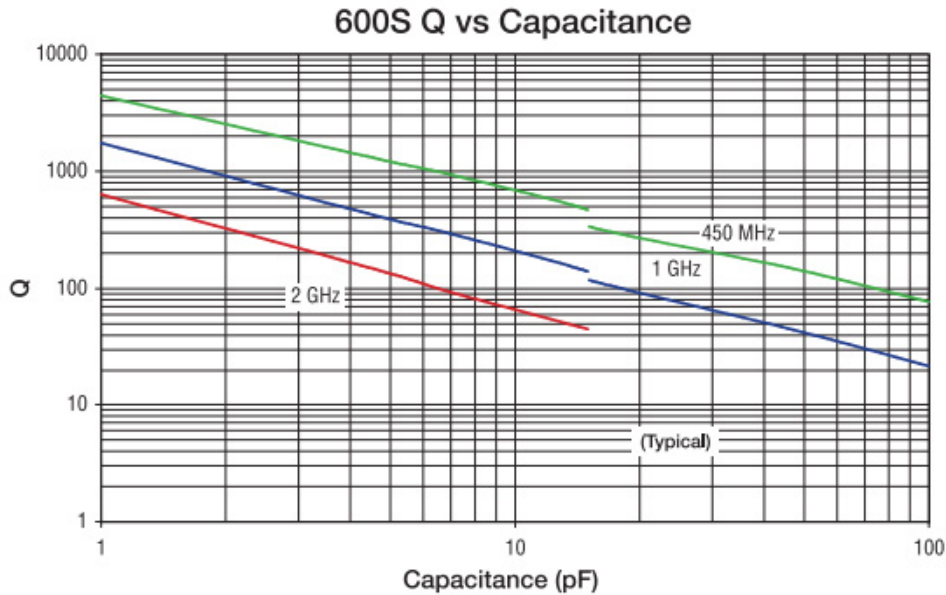

600F Series Data Sheet Condition Description

Capacitors horizontally mounted on 13.3-mil thick Rogers R0435® softboard 29-mils wide 1/2 oz. Cu traces
FSR = lowest frequency at which S11 response, referenced at capacitor edge, crosses real axis on Smith Chart.
FPR = lowest frequency at which there is a notch in S21 magnitude response.

RF/Microwave Capacitors
RF/Microwave Multilayer Capacitors (MLC)
600S Ultra-Low ESR, High Q, NPO Capacitors



OUTLINE DIMENSIONS

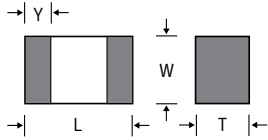

S (0603)	L: $.063 \pm .006$ (1.60 \pm 0.15)	T: $.035$ max (0.89 max)
	W: $.032 \pm .006$ (.81 \pm 0.15)	Y: $.014 \pm .006$ (0.36 \pm 0.15)

inches (mm)

SUGGESTED MOUNTING PAD DIMENSIONS

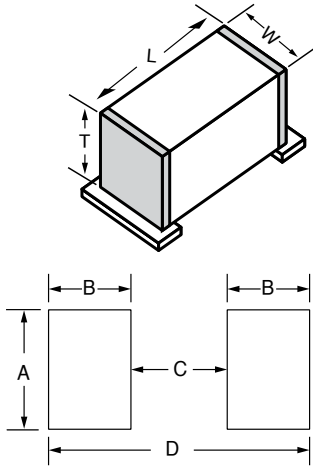

Case Size L, S, and F

Case Size	A Min.	B Min.	C Min.	D Min.
0402 (1005)	.0275 (0.70)	.0354 (0.90)	.0157 (0.40)	.0866 (2.20)
0603 (1608)	.0393 (1.00)	.0433 (1.10)	.0236 (0.60)	.110 (2.80)
0805 (2012)	.0590 (1.50)	.0512 (1.30)	.0236 (0.60)	.1259 (3.20)

inches (mm)

DESIGN KITS

Kit #	RoHS Compliant	Item #	Description	Cap. Value Range (pF)	Cap. Value (pF)	Tol. (pF)	Price
Kit 25T		DK0025T	600S Series Ultra-low ESR, High Q Microwave Capacitors 16 different values, 15 pcs. min. per value	0.1 to 2.0	0.1, 0.2, 0.3, 0.4, 0.5, 0.6, 0.7, 0.8, 0.9, 1.0, 1.1, 1.2, 1.5 \pm 0.1% 1.6, 1.8, 2.0 \pm 0.25%		\$100.00
Kit 26T		DK0026T	600S Series Ultra-low ESR, High Q Microwave Capacitors 16 different values, 15 pcs. min. per value	0.1 to 10	1.0, 1.2, 1.5, 1.8, 2.0, 2.2, 2.4, 2.7, 3.0, 3.3 \pm 0.1% 3.9, 4.7, 5.6, 6.8, 8.2 \pm 0.25% 10 \pm 5%		\$100.00
Kit 27T		DK0027T	600S Series Ultra-low ESR, High Q Microwave Capacitors 16 different values, 15 pcs. min. per value	10 to 100	10, 12, 15, 18, 20, 22, 24, 27, 30, 33, 39, 47 56, 68, 82, 100 \pm 5%		\$100.00

For Online Kit Orders, Catalog & Application Notes, Visit: www.avx.com

单击下面可查看定价，库存，交付和生命周期等信息

[>>AVX](#)