

# SCC Series

## High Capacitance Cylindrical SuperCapacitors

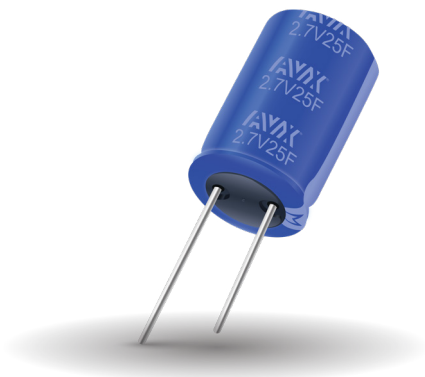

The new series of cylindrical electrochemical double-layer capacitors offers excellent pulse power handling characteristics based on the combination of very high capacitance and very low ESR. Used by themselves or in conjunction with primary or secondary batteries, they provide extended back up time, longer battery life, and provide instantaneous power pulses as needed. Offers great solutions to Hold Up, Energy Harvesting, and Pulse Power Applications.



### FEATURES

- Cap Values from 1F – 3000F
- High pulse power capability
- Low ESR
- Low Leakage Current

### APPLICATIONS

- Camera Flash Systems
- Energy Harvesting
- GSM/GPRS Pulse Applications
- UPS/Industrial
- Wireless Alarms
- Remote Metering
- Scanners
- Toys and Games

### HOW TO ORDER

<b>SCC</b> Series SuperCap Cylindrical	<b>R</b> Diameter Q = 6.3mm R = 8mm S = 10mm T = 12.5mm U = 16mm V = 18mm W = 22mm X = 30mm Y = 35mm Z = 60mm	<b>12</b> Case Length Two digits represent case length in mm, with the exception of the following: 1E = 138mm	<b>B</b> Voltage Code B = 2.7V	<b>105</b> Capacitance Code 1st two digits represent significant figures 3rd digit represents multiplier (number of zeros to follow) in $\mu$ F	<b>P</b> Tolerance P = +100%/-0% S = +30%/-10%	<b>R</b> Lead Format R = Radial S = Solder Pin N = Snap-in C = Weldable Lug W = Screw	<b>B</b> Package B = Bulk A = Ammo* T = Tray**	<b>-</b> Custom Code A1= 4mm Bent Leads* C1 = 2mm Bent Leads*
---	--	--	--------------------------------------	---	---	---	--	--

\* Inquire about availability for Radial Leads only  
\*\*Inquire about availability

### QUALITY INSPECTIONS

Parts are tested for Life Cycle, high temperature load life, temperature characteristics, vibration resistance, and humidity characteristics. See page 2 for more information.

### TERMINATION

These SuperCapacitors are compatible with hand soldering and wave soldering processes, so long as appropriate precautions are followed. See "Soldering Recommendations" on page 5 for more information.

### OPERATING TEMPERATURE

- 40°C to +65°C @ 2.7V
- 40°C to +85°C @ 2.3V



For RoHS compliant products, please select correct termination style.



### RATING & PART NUMBER REFERENCE

AVX Part Number	Diameter (mm)	Length (mm)	Rated Capacitance (F)	Capacitance Tolerance	Rated Voltage (V)	Rated Temperature (°C)	DCL Max @ 72 Hrs (µA)	ESR Max @ 1000 Hz (mΩ)	ESR Max @ DC (mΩ)	Peak Current (A)	Power Density (W/kg)	Max Energy (Wh)	Energy Density (Wh/kg)
<b>Radial Lead</b>													
SCCQ12B105PRB	6.3	12	1	+100%/-0%	2.7/2.3*	65/85*	6	200	500	0.90	2692	0.0010	1.56
SCCR12B105PRB	8	12	1	+100%/-0%	2.7/2.3*	65/85*	6	150	500	0.90	1842	0.0010	1.07
SCCQ15B125SRB	6.3	15	1.2	+30%/-10%	2.7/2.3*	65/85*	6	240	620	0.93	1933	0.0012	1.66
SCCR16B205PRB	8	16	2	+100%/-0%	2.7/2.3*	65/85*	10	100	360	1.57	2113	0.0020	1.76
SCCR20B335PRB	8	20	3.3	+100%/-0%	2.7/2.3*	65/85*	12	95	290	2.28	2080	0.0033	2.30
SCCR25B505PRB	8	25	5	+100%/-0%	2.7/2.3*	65/85*	15	85	220	3.21	2339	0.0051	2.98
SCCS20B505PRB	10	20	5	+100%/-0%	2.7/2.3*	65/85*	15	70	180	3.55	2314	0.0051	2.41
SCCS25B705PRB	10	25	7	+100%/-0%	2.7/2.3*	65/85*	20	60	150	4.61	2243	0.0071	2.73
SCCS30B106PRB	10	30	10	+100%/-0%	2.7/2.3*	65/85*	30	40	75	7.71	3763	0.0101	3.27
SCCT20B106PRB	12.5	20	10	+100%/-0%	2.7/2.3*	65/85*	30	50	75	7.71	3431	0.0101	2.98
SCCS30B126SRB	10	30	12	+30%/-10%	2.7/2.3*	65/85*	30	50	75	8.53	3812	0.0122	3.97
SCCT30B156SRB	12.5	30	15	+30%/-10%	2.7/2.3*	65/85*	50	35	80	9.20	2430	0.0152	3.38
SCCT30B186SRB	12.5	30	18	+30%/-10%	2.7/2.3*	65/85*	55	40	60	11.68	3378	0.0182	4.93
SCCT35B226SRB	12.5	35	22	+30%/-10%	2.7/2.3*	65/85*	58	34	58	13.05	2631	0.0223	3.89
SCCU25B256SRB	16	25	25	+30%/-10%	2.7/2.3*	65/85*	60	27	50	15.00	2397	0.0253	3.47
SCCU30B356SRB	16	30	35	+30%/-10%	2.7/2.3*	65/85*	70	20	40	19.69	2514	0.0354	4.07
SCCT47B406SRB	12.5	47	40	+30%/-10%	2.7/2.3*	65/85*	75	19	29	25.00	4022	0.0405	5.40
SCCV40B506SRB	18	40	50	+30%/-10%	2.7/2.3*	65/85*	75	18	20	33.75	3365	0.0506	3.89
SCCV60B107SRB	18	60	100	+30%/-10%	2.7/2.3*	65/85*	260	15	18	48.21	2430	0.1013	5.06
<b>Solder Pin Lead</b>													
SCCW45B107SSB	22	45	100	+30%/-10%	2.7/2.3*	65/85*	260	8	12	61.36	3391	0.1013	4.71
SCCX50B207SSB	30	50	200	+30%/-10%	2.7/2.3*	65/85*	600	6	9	96.43	2461	0.2025	5.13
SCCY62B307SSB	35	62	300	+30%/-10%	2.7/2.3*	65/85*	650	6	9	109.46	1262	0.3038	3.94
SCCY68B407SSB	35	68	400	+30%/-10%	2.7/2.3*	65/85*	1000	4	5	180.00	2046	0.4050	4.74
<b>Snap-In</b>													
SCCY60B407SNB	35	60	400	+30%/-10%	2.7/2.3*	65/85*	1000	4	5	180.00	2430	0.4050	5.63
<b>Cylindrical Lug Lead</b>													
SCCZ1EB308SCB	60	138	3000	+30%/-10%	2.7/2.3*	65/85*	5200	0.2	0.29	2165.78	6033	3.0375	6.08
<b>Cylindrical Screw Lead</b>													
SCCZ1EB308SWB	60	138	3000	+30%/-10%	2.7/2.3*	65/85*	5200	0.2	0.29	2165.78	6033	3.0375	6.08

\*with appropriate voltage derating operating temperature can be extended to 85°C

### QUALIFICATION TEST SUMMARY

Test	Test Method	Parameter	Limits
<b>Life Cycle</b>	Capacitors are cycled between rated voltage and half-rated voltage under constant current at +25°C for 500,000 cycles	Capacitance ESR Appearance	≤30% of spec value ≤200% of spec value No remarkable defects
<b>High Temperature Load Life</b>	Temperature: +65°C Voltage: Rated Voltage Test Duration: 1,000 hours	Capacitance ESR Appearance	≤30% of spec value ≤200% of spec value No remarkable defects
<b>Storage Temperature Characteristics</b>	Storage Duration: 2 years No Load Temperature: +35°C	Capacitance ESR Appearance	≤30% of spec value ≤200% of spec value No remarkable defects
<b>Vibration Resistance</b>	Amplitude: 1.5mm Frequency: 10 ~ 55Hz Direction: X, Y, Z for 2 hours each	Capacitance ESR Appearance	≤30% of spec value ≤200% of spec value No remarkable defects
<b>Humidity</b>	Voltage: Rated Voltage RH: 90% Temperature: +60°C Test Duration: 1,000 hours	Capacitance ESR Appearance	≤30% of spec value ≤200% of spec value No remarkable defects

### QUALITY AND RELIABILITY

CAPACITANCE VS. TEMPERATURE

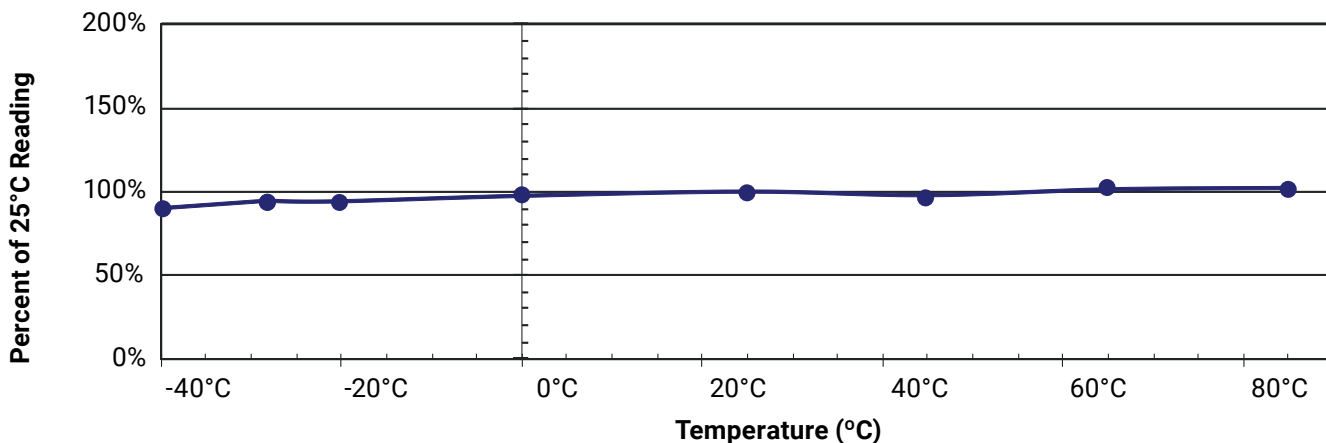

LEAKAGE CURRENT VS. TEMPERATURE

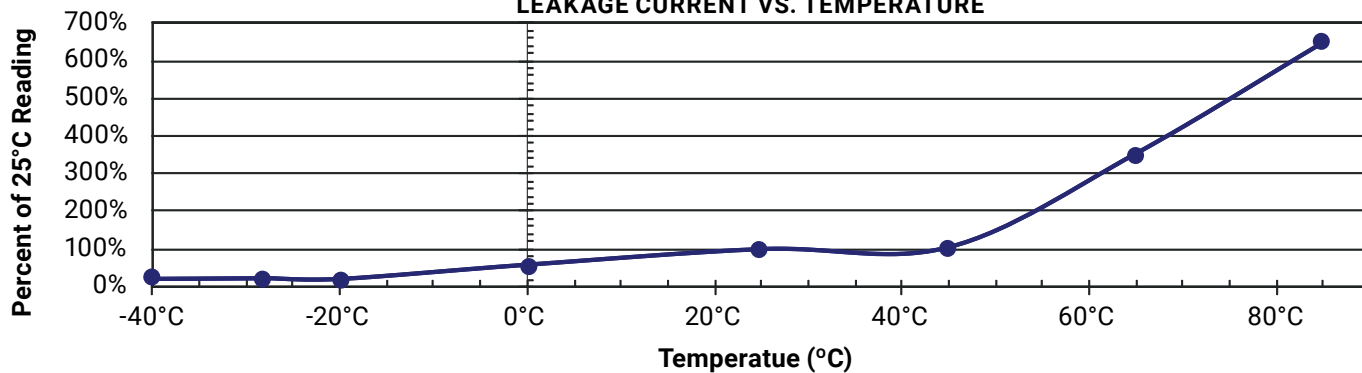

EQUIVALENT SERIES RESISTANCE VS. TEMPERATURE

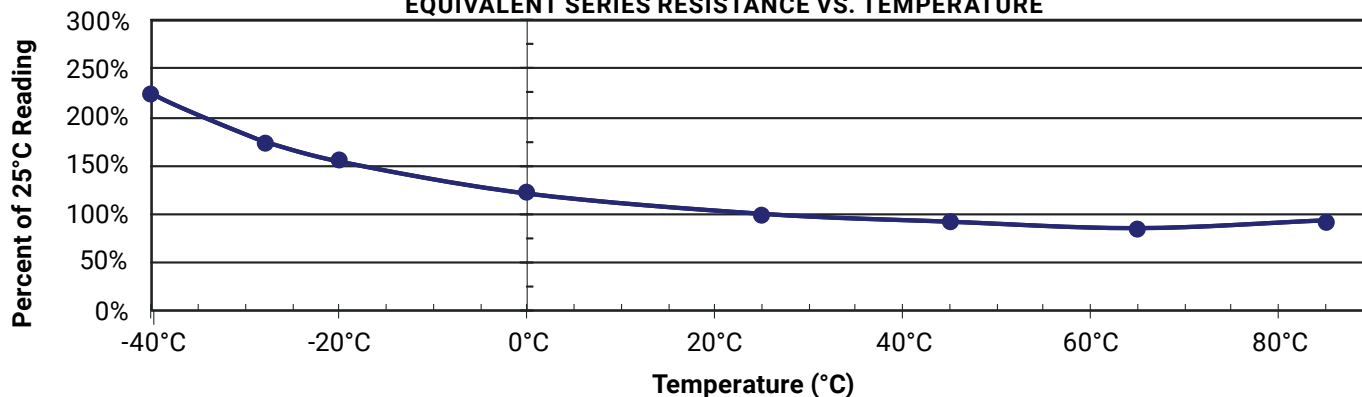

# SCC Series

## High Capacitance Cylindrical SuperCapacitors

### MECHANICAL SPECIFICATIONS

#### RADIAL LEAD TYPE 1F – 100F

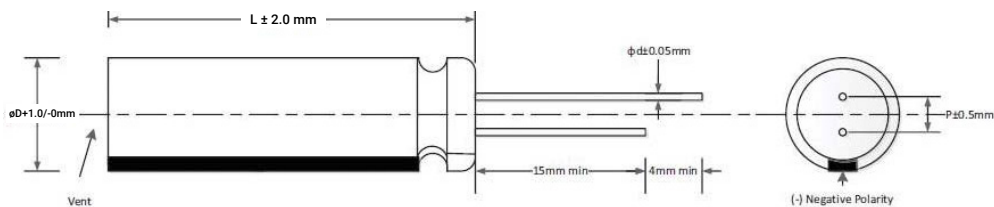

D (mm)	P (mm)	d (mm)
6.3	2.3	0.6
8	3.2	0.6
10	5.0	0.6
12.5	5.3	0.6*
16	7.3	0.8
18	7.7	0.8

\*For parts with Diameter (D)=12.5mm:  
If Length ≤ 30mm, Lead Diameter (d)=0.6mm  
If Length ≥ 35mm, Lead Diameter (d)=0.8mm

#### RADIAL BENT LEAD TYPE

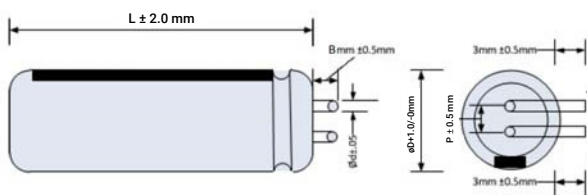

Style	B (mm)
A1	4
C1	2

#### SOLDER PIN TYPE 4-PIN 300F, 400F PARTS

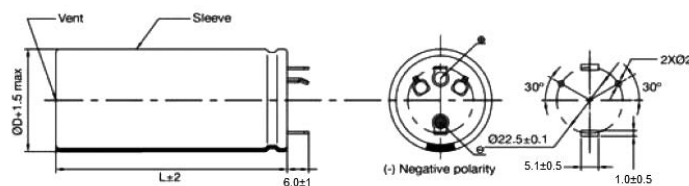

Cap (F)	D (mm)	L (mm)
300	35	62
400	35	68

#### SOLDER PIN TYPE 2 PIN 100F, 200F PART

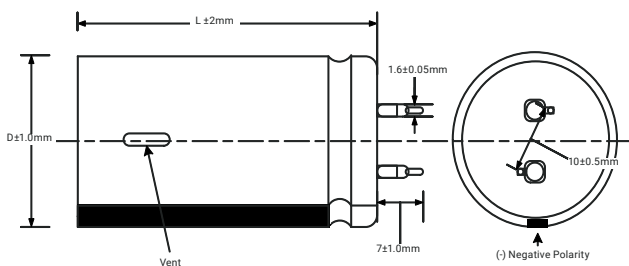

#### SNAP-IN 400F PART

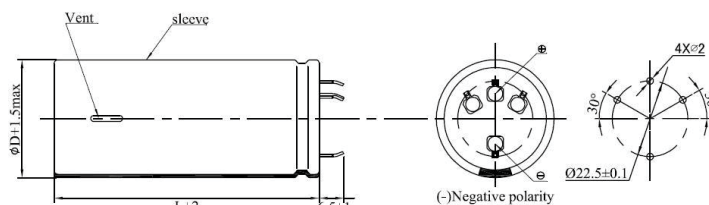

#### WELDABLE LUG TYPE 3000F PART

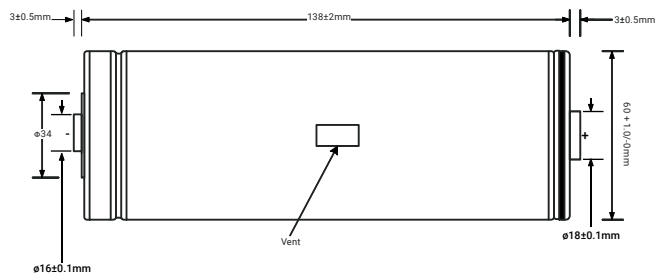

#### CYLINDRICAL SCREW TYPE 3000F PART

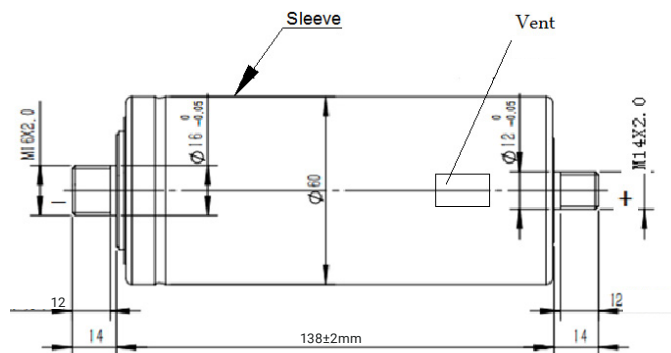

# SCC Series

## High Capacitance Cylindrical SuperCapacitors



### SOLDERING RECOMMENDATIONS

When soldering SuperCapacitors to a PCB, the temperature & time that the body of the SuperCapacitor sees during soldering can have a negative effect on performance. We advise following these guidelines:

- Do not immerse the SuperCapacitors in solder. Only the leads should come in contact with the solder.
- Ensure that the body of the SuperCapacitor is never in contact with the molten solder, the PCB or other components during soldering.
- Excessive temperatures or excessive temperature cycling during soldering may cause the safety vent to burst or the case to shrink or crack, potentially damaging the PCB or other components, and significantly reduce the life of the capacitor.

**PRECAUTION:** For all products with shrink wrap sleeves, washing in any type of cleaning agent is prohibited. During all soldering processes, it's recommended to protect the shrink wrap from any kind of liquid (including but not limited to: water, strong acid, strong alkali, strong oxidizing solutions, and strong solvents) to avoid the risk of damage, cracking, and fading of the outer shrink wrap.

### HAND SOLDERING

Keep distance between the SuperCapacitor body and the tip of the soldering iron and the tip should never touch the body of the capacitor. Contact between SuperCapacitor body and soldering iron will cause extensive damage to the SuperCapacitor, and change its electrical properties. It is recommended that the soldering iron temperature should be less than 350°C, and contact time should be limited to less than 4 seconds. Too much exposure to terminal heat during soldering can cause heat to transfer to the body of the SuperCapacitor, potentially damaging the electrical properties of the SuperCapacitor.

### WAVE SOLDERING

Only use wave soldering on Radial type SuperCapacitors. The PCB should be preheated only from the bottom and for less than 60 seconds, with temperature at, or below, 100°C on the top side of the board for PCBs equal to or greater than 0.8 mm thick.

Solder Temperature (°C)	Suggested Solder Time (s)	Maximum Solder Time (s)
220	7	9
240	7	9
250	5	7
260	3	5



### TEST METHODS

#### IEC CAPACITANCE TEST METHOD

Procedure: Charge module under constant current to rated voltage at room temperature, then hold 10 minutes on charge under constant voltage. After 10 minutes, discharge under constant current (as shown in chart below), recording voltage at  $V_1$ ,  $V_2$ , and time intervals at  $t_1$  and  $t_2$ . Use the capacitance formula to determine cap value.

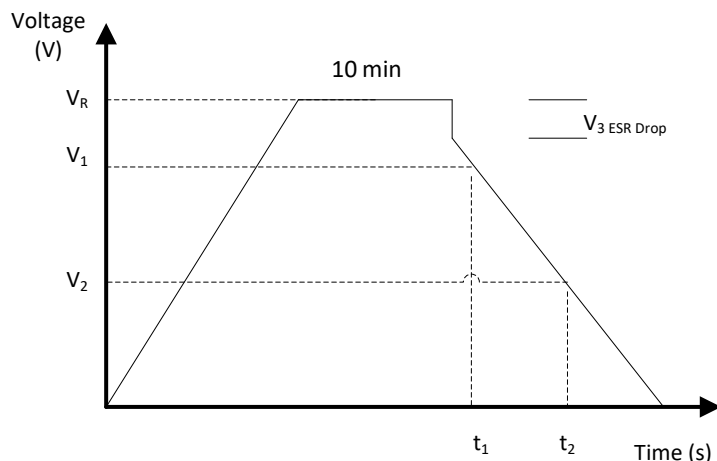

$I$  – Discharge Current,  $4 \times C \times V_R$  (mA)

$V_R$  – Rated Voltage (V)

$V_1$  – Initial Test Voltage, 80% Of  $V_R$  (V)

$V_2$  – Final Test Voltage, 40% Of  $V_R$  (V)

$t_1$  – Initial Test Time (s)

$t_2$  – Final Test Time (s)

$$C = \frac{I \times (t_2 - t_1)}{V_1 - V_2}$$

#### DC ESR MEASUREMENT

A six-step ESR<sub>DC</sub> test method is illustrated to the right and carried out as follows:

- Rest 10 Seconds
- Charge under constant current ( $I_1$ ) to rated voltage ( $V_R$ )
- Rest 5 seconds
- Rest 10 seconds, record  $V_3$  and  $t_4$
- Discharge under constant current ( $I_2$ ) to half rated voltage, Record  $I_2$ ,  $V_4$ , And  $t_5$
- Rest 5 seconds, record  $V_5$  And  $t_6$

Repeat steps 1-6 recording  $I$ ,  $V$ , And  $t$  accordingly, finally discharging to below 0.1V under constant current ( $I_2$ ).

Formulas to calculate:

• Two cycle discharge capacitances:  $C_{dch1} = I_2 \times \frac{(t_5 - t_4)}{V_3 - V_4}$ ;  $C_{dch2} = I_2 \times \frac{(t_{11} - t_{10})}{(V_9 - V_{10})}$

• Discharge capacitance:  $C_{dch} = \frac{(C_{dch1} + C_{dch2})}{2}$

• Two cycle discharge DC ESR:  $ESR_{dch1} = \frac{(V_5 - V_4)}{I_2}$ ;  $ESR_{dch2} = \frac{(V_{11} - V_{10})}{I_2}$

• Discharge DC ESR:  $ESR_{dch} = \frac{(ESR_{dch1} + ESR_{dch2})}{2}$

Note:  $I_1 = I_2 = 75\text{mA/F}$ , the rated capacitance in the chart means discharge capacitance, and DC ESR ( $ESR_{DC}$ ) means discharge DC resistance.

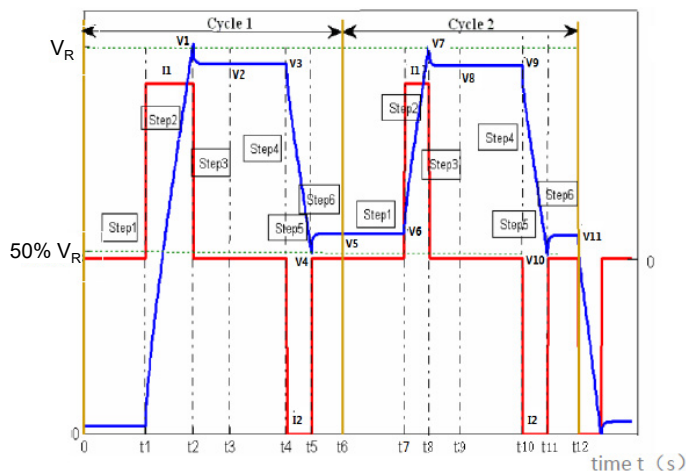

### TEST METHODS (continued)

#### MAXIMUM CONTINUOUS CURRENT

- This is the maximum current when temperature rise of the supercapacitor during its operation is less than 15°C

#### MAXIMUM PEAK CURRENT

- This is the maximum current during 1 second time interval (dt)

#### WATT DENSITY

- Watt Density =  $(0.12 \cdot V^2 / R_{DC}) / \text{mass}$

#### ENERGY DENSITY

- Energy Density =  $(\frac{1}{2} CV^2) / (3600 \cdot \text{mass})$

### POLARITY AND REVERSE VOLTAGE

For product consistency and optimum performance, it is recommended that the capacitor be connected with polarity indicated. Reversing polarity could result in permanent damage to the circuit including much higher leakage current for a short duration of time and the life time of the supercapacitors will be reduced.

### LIFE TIME AND TEMPERATURE PERFORMANCE

The life of a supercapacitor is impacted by a combination of operating voltage and the operating temperature according to the following Time to Failure equation:

$$t \propto V^n \times e^{\left(\frac{-Q}{kT}\right)}$$

where V is the operating voltage, Q is the activation energy in electron volts (eV), k is the Boltzmann constant in eV, and T is the operating temperature in Kelvin (K). Typical values for the voltage exponent, n, is between 2.5-3.5, and Q is between 1.0-1.2 eV in the normal operating temperature range of -40° to 65°C.

The industry standard for supercapacitor end of life is when the equivalent series resistance, ESR, increases to 200% of the specified value and the capacitance drops by 30% from specified value. Typically a supercapacitor shows an initial “jump” in the ESR value and then levels off. If the supercapacitors are exposed to excessive temperatures the ESR will show a continuous degradation (increase). In the extreme case, if the temperature or voltage are substantially higher than the rated specifications, this could result in the part venting and the product showing a faster degradation of capacitance and ESR, which may be many times the specified value.

Expected Lifetime at Various Voltages  
SCC Series

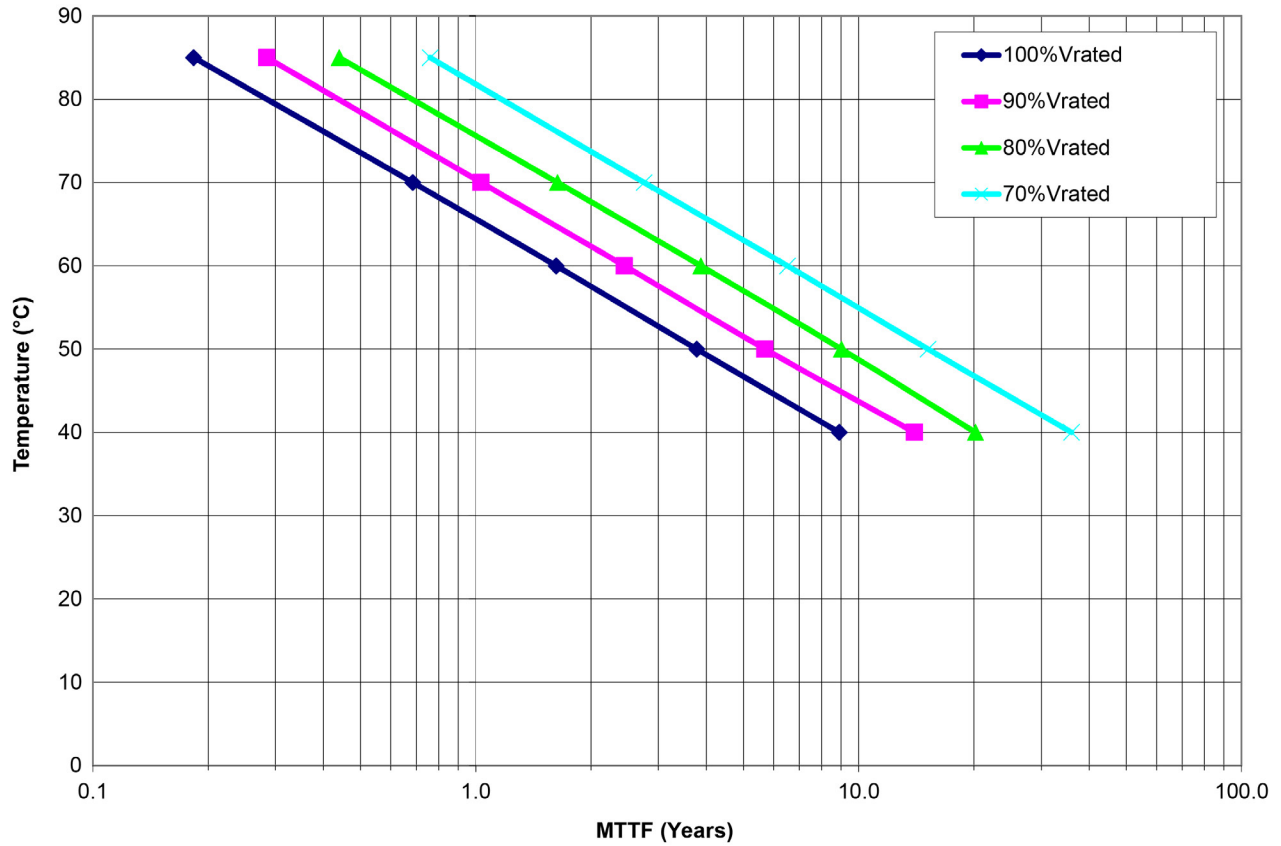



# SCC Series

## High Capacitance Cylindrical SuperCapacitors



### SAFETY RECOMMENDATIONS

#### WARNINGS

- To Avoid Short Circuit, after usage or test, SuperCapacitor voltage needs to discharge to  $\leq 0.1V$
- Do not Apply Overvoltage, Reverse Charge, Burn or Heat Higher than  $150^{\circ}C$ , explosion-proof valve may break open
- Do not Press, Damage or disassemble the SuperCapacitor, housing could heat to high temperature causing Burns
- If you observe Overheating or Burning Smell from the capacitor disconnect Power immediately, and do not touch

#### EMERGENCY APPLICATIONS

If Housing is Leaking:

- Skin Contact: Use soap and water thoroughly to wash the area of the skin
- Eye Contact: Flush with flowing water or saline, and immediately seek medical treatment
- Ingestion: Immediately wash with water and seek medical treatment

#### TRANSPORTATION

Not subjected to US DOT or IATA regulations

UN3499, <10Wh, Non-Hazardous Goods

International shipping description – “Electronic Products – Capacitor”

Licensed by CAP-XX

#### REGULATORY

- UL 810A
- RoHS Compliant
- REACH Compliant
- Halogen free according to IEC 61249-2-21: 2003 and IPC/JEDEC-J-STD-709

#### STORAGE

Capacitors may be stored within the temperature range of  $-40^{\circ}C$  to  $+70^{\circ}C$  with humidity  $< 60\%$ . Lower storage temperature is preferred as it extends the shelf life of the capacitor. Product over one year and within two years of the date code, we recommend recharging the product at the beginning of use for at least 24 hours.

Optimum storage conditions are as follows:

- $25^{\circ}C$  and  $RH \leq 60\%$  without voltage applied
- Not in direct sunlight
- Not in direct contact with water, salt oil or other chemicals
- Not in direct contact with corrosive materials, acids, alkalis, or toxic gases
- Not in dusty environments
- Not in environments with shock and vibration conditions



单击下面可查看定价，库存，交付和生命周期等信息

[>>AVX](#)