

ACCU-GUARD® TECHNOLOGY

The Accu-Guard® series of fuses is based on thin-film techniques. This technology provides a level of control on the component electrical and physical characteristics that is generally not possible with standard fuse technologies. This has allowed AVX to offer a series of devices which are designed for modern surface mount circuit boards which require protection.

FEATURES

- Accurate current rating
- Fast acting
- Small-standard 0402, 0603, 0805, 1206 and 0612 chip sizes
- Taped and reeled
- Completely compatible with all soldering systems used for SMT
- Lead Free Series (F0402E, F0402G, F0603E, F0805B, F1206B)

APPLICATIONS

- Cellular Telephones
- Two-Way Radios
- Computers
- Battery Chargers
- Rechargeable Battery Packs
- Hard Disk Drives
- PDA's
- LCD Screens
- SCSI Interface
- Digital Cameras
- Video Cameras

APPROVAL FILE NUMBERS

- UL, cUL: RCD#E143842
- UL (F0402G): RCD#E141069

DIMENSIONS millimeters (inches)

F0603C, F0805B, F1206A and F1206B

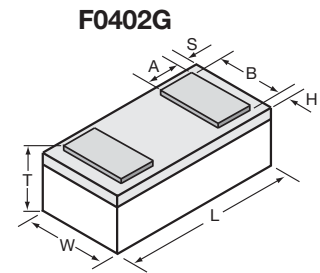
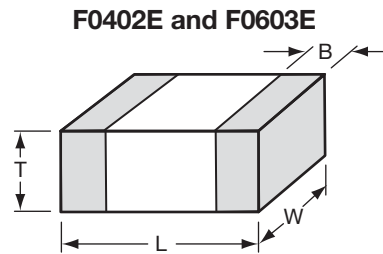
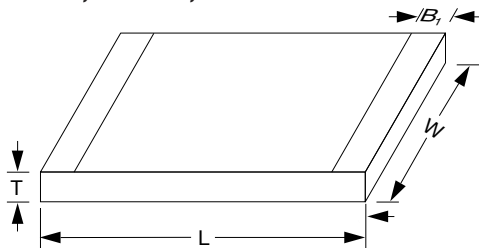

| | F0402G | F0402E | F0603E | F0603C | F0805B | F1206A/B | F0612D |
|-------------|----------------------------|----------------------------|----------------------------|----------------------------|----------------------------|----------------------------|----------------------------|
| L | 1.00±0.05 (0.039±0.002) | 1.00±0.10 (0.039±0.004) | 1.60±0.10 (0.063±0.004) | 1.65±0.25 (0.065±0.010) | 2.1±0.2 (0.083±0.008) | 3.1±0.2 (0.122±0.008) | 1.65±0.25 (0.065±0.010) |
| W | 0.58±0.04 (0.023±0.002) | 0.55±0.07 (0.022±0.003) | 0.81±0.10 (0.032±0.004) | 0.80±0.15 (0.031±0.006) | 1.27±0.1 (0.050±0.004) | 1.6±0.1 (0.063±0.004) | 3.1±0.2 (0.122±0.008) |
| T | 0.35±0.05 (0.014±0.002) | 0.40±0.10 (0.016±0.004) | 0.63±0.10 (0.025±0.004) | 0.90±0.2 (0.035±0.008) | 0.90±0.2 (0.035±0.008) | 1.2±0.2 (0.047±0.008) | 0.90±0.2 (0.036±0.008) |
| B | 0.48±0.05 (0.019±0.002) | 0.20±0.10 (0.008±0.004) | 0.35±0.15 (0.014±0.006) | 0.35±0.15 (0.014±0.006) | 0.30±0.15 (0.012±0.006) | 0.43±0.25 (0.017±0.010) | 0.35±0.15 (0.014±0.006) |
| A | 0.20±0.05 (0.008±0.002) | | | | | | |
| S, H | 0.05±0.05 (0.002±0.002) | | | | | | |

HOW TO ORDER

| | | | | | | |
|-----------------|---|---|---|----------------------|---|-------------------------------|
| F | 1206 | A | 0R20 | F | W | TR |
| Product Fuse | Size See table for standard sizes | Fuse Version A=Accu-Guard® B=Accu-Guard® II C=Accu-Guard® II 0603 D=Accu-Guard® II 0612 E=Accu-Guard® II 0402, 0603 G=Accu-Guard® II 0402 Low Current | Rated Current Current expressed in Amps. Letter R denotes decimal point. e.g. 0.20A=0R20 1.75A=1R75 | Fuse Speed F=Fast | Termination S=Nickel/Lead- Free Solder coated (Sn 100) W=Nickel/solder coated (Sn 63, Pb 37) | Packaging TR=Tape and reel |

SMD Thin-Film Fuse

Accu-Guard® II is a version of Accu-Guard® fuses for a wider range of current and voltage ratings. Constructed on alumina substrates, Accu-Guard® II fuses display superior electrical, mechanical and environmental properties. Accu-Guard® II dimensions are standard 0402, 0603, 0805, 1206 and 0612 chip sizes, see page 2.

ELECTRICAL SPECIFICATIONS

Operating temperature: -55°C to +125°C

Current carrying capacity:

For F0402E and F0603E at -55°C 107% of rating, at -25°C 100% of rating, at +125°C 80% of rating. For F0603C at -55°C is 107% of rating, at +25°C 100% of rating, at +85°C 90% of rating, at +125°C 75% of rating.

For F1206B and F0805B at -55°C is 107% of rating, at +25°C 100% of rating, at +85°C 93% of rating, at +125°C 90% of rating. For F0805B 2.50A and 3.00A at +85°C 90% of rating, at +125°C 90% of rating.

Interrupting rating: 50A.

Insulation resistance: >20MΩ guaranteed (after fusing at rated voltage).

For F0612D at -55°C 107% of rating, at +25°C 100% of rating, at +85°C 80% of rating, at +125°C 75% of rating.

| Type | Part Number | Current Rating A | Resistance 10% x I rated, 25°C Ω (max.) | Voltage Drop @1 x I rated, 25°C mV (max.) | Fusing Current (within 5 sec), 25°C A | Pre-Arc I ² t @ 50A A ² -sec | Rated Voltage V |
|--------|------------------|---------------------|---|---|---|--|--------------------|
| F0402E | F0402E0R25FSTR | 0.25 | 0.650 | 220 | 0.625 | 0.00005* | 32 |
| | F0402E0R50FSTR | 0.50 | 0.250 | 180 | 1.25 | 0.0003 | 32 |
| | F0402E0R75FSTR | 0.75 | 0.200 | 180 | 1.875 | 0.003 | 32 |
| | F0402E1R00FSTR | 1.00 | 0.130 | 160 | 2.50 | 0.008 | 32 |
| | F0402E1R50FSTR | 1.50 | 0.060 | 140 | 3.75 | 0.03 | 32 |
| F0603E | F0402E2R00FSTR | 2.00 | 0.040 | 120 | 5.00 | 0.06 | 32 |
| | F0603E0R25FSTR | 0.25 | 0.650 | 220 | 0.625 | 0.00005* | 32 |
| | F0603E0R37FSTR | 0.375 | 0.450 | 220 | 0.940 | 0.0001 | 32 |
| | F0603E0R50FSTR | 0.50 | 0.250 | 180 | 1.25 | 0.0003 | 32 |
| | F0603E0R75FSTR | 0.75 | 0.200 | 180 | 1.875 | 0.003 | 32 |
| | F0603E1R00FSTR | 1.00 | 0.130 | 160 | 2.50 | 0.008 | 32 |
| | F0603E1R25FSTR | 1.25 | 0.090 | 140 | 3.125 | 0.01 | 32 |
| | F0603E1R50FSTR | 1.50 | 0.060 | 140 | 3.75 | 0.03 | 32 |
| | F0603E1R75FSTR | 1.75 | 0.050 | 120 | 4.375 | 0.04 | 32 |
| F0603C | F0603E2R00FSTR | 2.00 | 0.040 | 120 | 5.00 | 0.06 | 32 |
| | F0603E2R50FSTR | 2.50 | 0.035 | 100 | 6.25 | 0.12 | 32 |
| | F0603E3R00FSTR | 3.00 | 0.030 | 100 | 7.50 | 0.25 | 32 |
| | F0603C0R25FWTR | 0.25 | 0.800 | 280 | 0.50 | 0.00003* | 32 |
| | F0603C0R37FWTR | 0.375 | 0.500 | 280 | 0.75 | 0.0001 | 32 |
| | F0603C0R50FWTR | 0.50 | 0.320 | 280 | 1.00 | 0.0002 | 32 |
| | F0603C0R75FWTR | 0.75 | 0.300 | 280 | 1.50 | 0.0015 | 32 |
| | F0603C1R00FWTR | 1.00 | 0.200 | 240 | 2.00 | 0.004 | 32 |
| | F0603C1R25FWTR | 1.25 | 0.170 | 240 | 2.50 | 0.007 | 32 |
| | F0603C1R50FWTR | 1.50 | 0.110 | 240 | 3.00 | 0.012 | 32 |
| F0805B | F0603C1R75FWTR | 1.75 | 0.090 | 240 | 3.50 | 0.02 | 24 |
| | F0603C2R00FWTR | 2.00 | 0.075 | 240 | 4.00 | 0.03 | 24 |
| | F0603C2R50FWTR | 2.50 | 0.055 | 200 | 5.00 | 0.05 | 16 |
| | F0603C3R00FWTR | 3.00 | 0.045 | 200 | 6.00 | 0.1 | 16 |
| | F0805B0R25FW/STR | 0.25 | 0.750 | 280 | 0.50 | 0.00003* | 63 |
| | F0805B0R50FW/STR | 0.50 | 0.350 | 280 | 1.00 | 0.0002 | 63 |
| | F0805B0R75FW/STR | 0.75 | 0.270 | 280 | 1.50 | 0.001 | 63 |
| | F0805B1R00FW/STR | 1.00 | 0.220 | 280 | 2.00 | 0.003 | 63 |
| | F0805B1R25FW/STR | 1.25 | 0.170 | 280 | 2.50 | 0.007 | 63 |
| F1206B | F0805B1R50FW/STR | 1.50 | 0.120 | 240 | 3.00 | 0.010 | 63 |
| | F0805B2R00FW/STR | 2.00 | 0.080 | 220 | 4.00 | 0.030 | 63 |
| | F0805B2R50FW/STR | 2.50 | 0.060 | 220 | 5.00 | 0.050 | 63 |
| | F0805B3R00FW/STR | 3.00 | 0.050 | 220 | 6.00 | 0.10 | 63 |
| | F1206B0R25FW/STR | 0.25 | 0.750 | 280 | 0.50 | 0.00003 | 63 |
| | F1206B0R50FW/STR | 0.50 | 0.350 | 280 | 1.00 | 0.0002 | 63 |
| | F1206B1R00FW/STR | 1.00 | 0.180 | 240 | 2.00 | 0.003 | 63 |
| | F1206B1R50FW/STR | 1.50 | 0.120 | 240 | 3.00 | 0.010 | 63 |
| F0612D | F1206B2R00FW/STR | 2.00 | 0.080 | 220 | 4.00 | 0.030 | 63 |
| | F1206B3R00FW/STR | 3.00 | 0.050 | 220 | 6.00 | 0.10 | 63 |
| | F0612D4R00FWTR | 4.00 | 0.040 | 260 | 10 | 0.10 | 32 |
| | F0612D5R00FWTR | 5.00 | 0.025 | 200 | 12.5 | 0.25 | 32 |

*Current is limited to less than 50A at 32V due to internal fuse resistance.

ENVIRONMENTAL CHARACTERISTICS

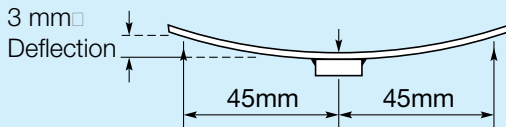
| Test | Conditions | Requirement |
|-----------------------------|--|--|
| Solderability | Components completely immersed in a solder bath at 235 ±5°C for 2 secs. | Terminations to be well tinned No visible damage |
| Leach Resistance | Completely immersed in a solder bath at 260 ±5°C for 60 secs. | Dissolution of termination ≤ 25% of area $\Delta R/R < 10\%$ |
| Storage | 12 months minimum with components stored in "as received" packaging. | Good solderability |
| Shear | Components mounted to a substrate. A force of 5N applied normal to the line joining the terminations and in a line parallel to the substrate. | No visible damage |
| Rapid Change of Temperature | Components mounted to a substrate. 50 cycles -55°C to +125°C. | No visible damage $\Delta R/R < 10\%$ |
| Vibration | Per Mil-Std-202F Method 201A and Method 204D Condition D. | No visible damage $\Delta R/R < 10\%$ |
| Bend | Tested as shown in diagram  | No visible damage $\Delta R/R < 10\%$ |
| Load Life F0805B, F1206B | 25°C, rated current, 20,000 hrs. | No visible damage $\Delta R/R < 10\%$ |

FUSE TIME - CURRENT CHARACTERISTICS FOR TYPE F0402E (TYPICAL)

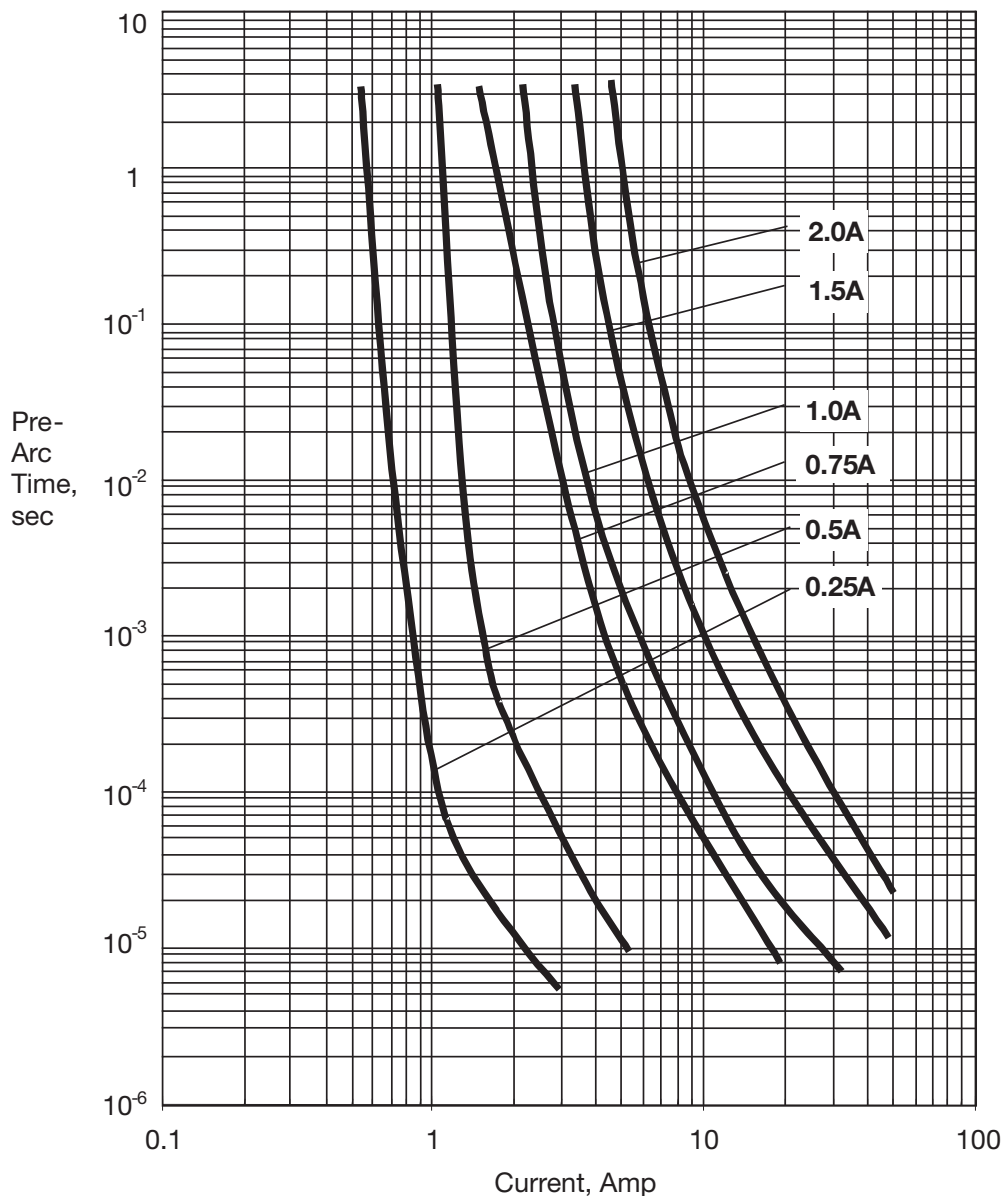

FUSE PRE-ARC JOULE INTEGRALS VS CURRENT FOR TYPE F0402E (TYPICAL)

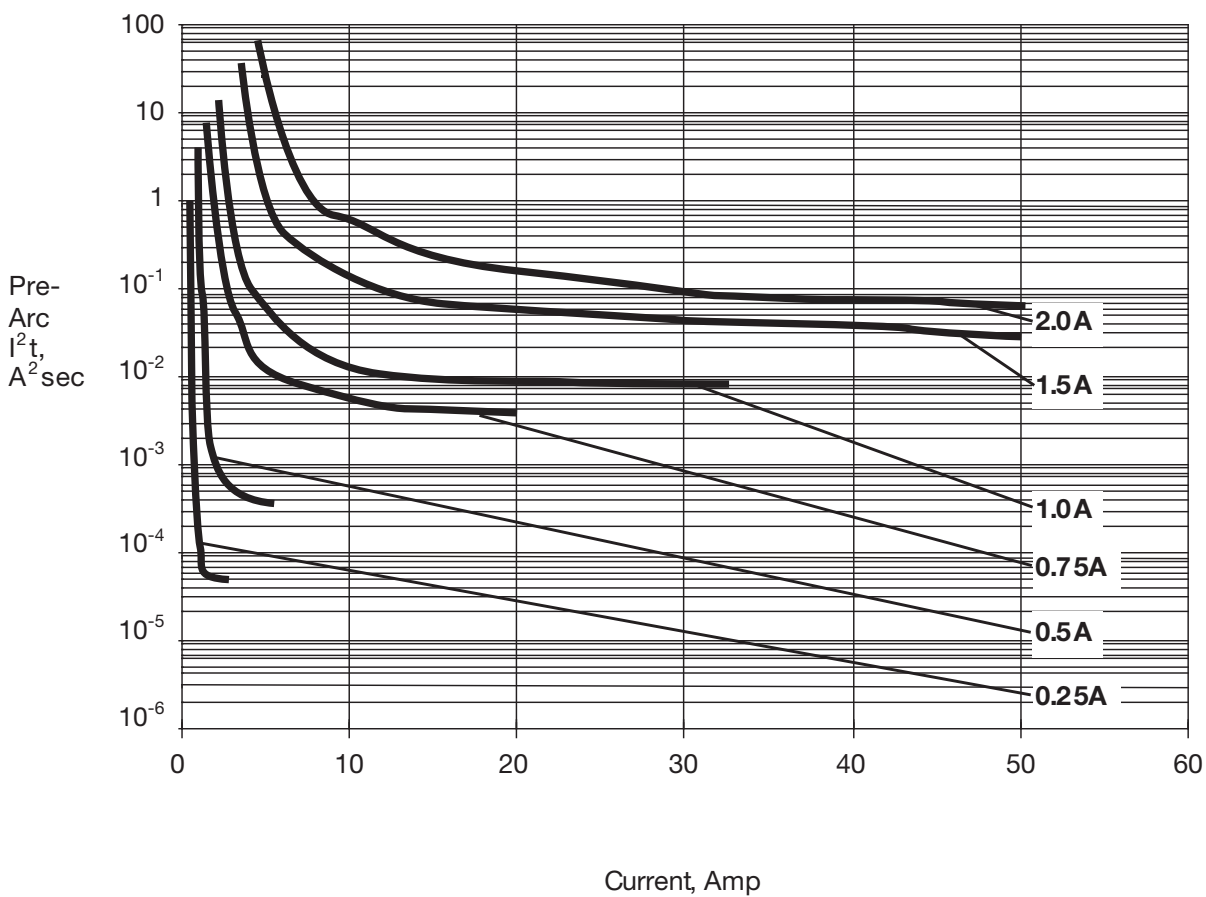

FUSE PRE-ARC JOULE INTEGRALS VS PRE-ARC TIME FOR TYPE F0402E (TYPICAL)

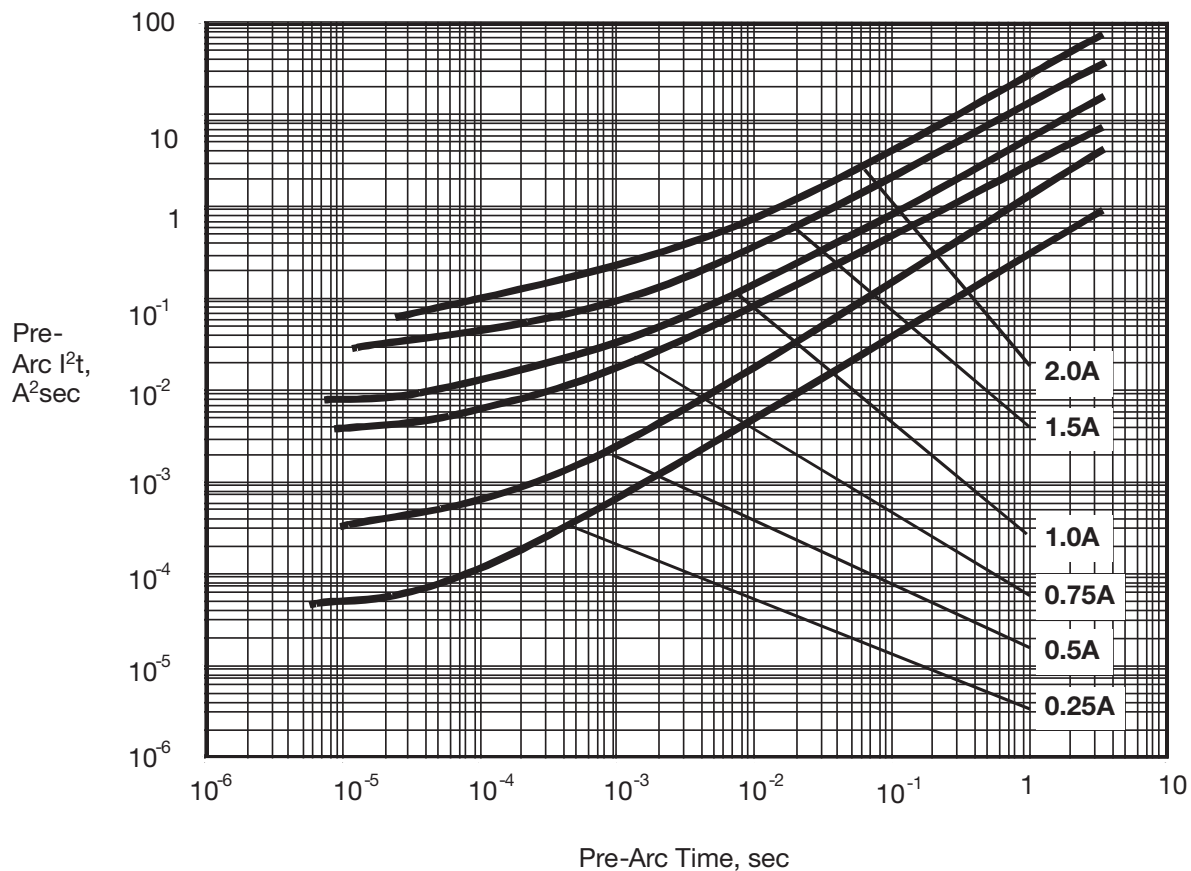

FUSE TIME - CURRENT CHARACTERISTICS FOR TYPE F0603E (TYPICAL)

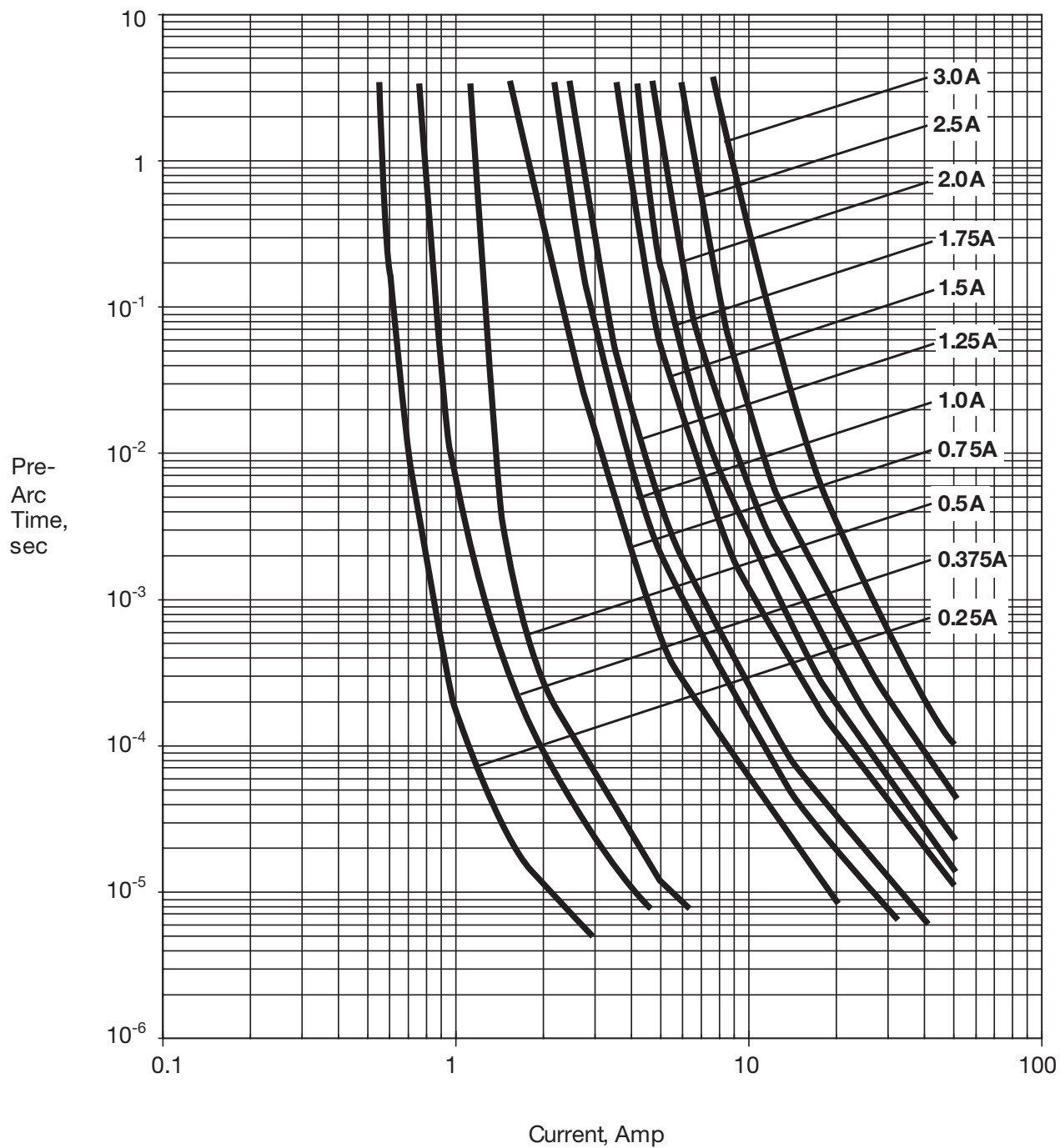

FUSE PRE-ARC JOULE INTEGRALS VS CURRENT FOR TYPE F0603E (TYPICAL)

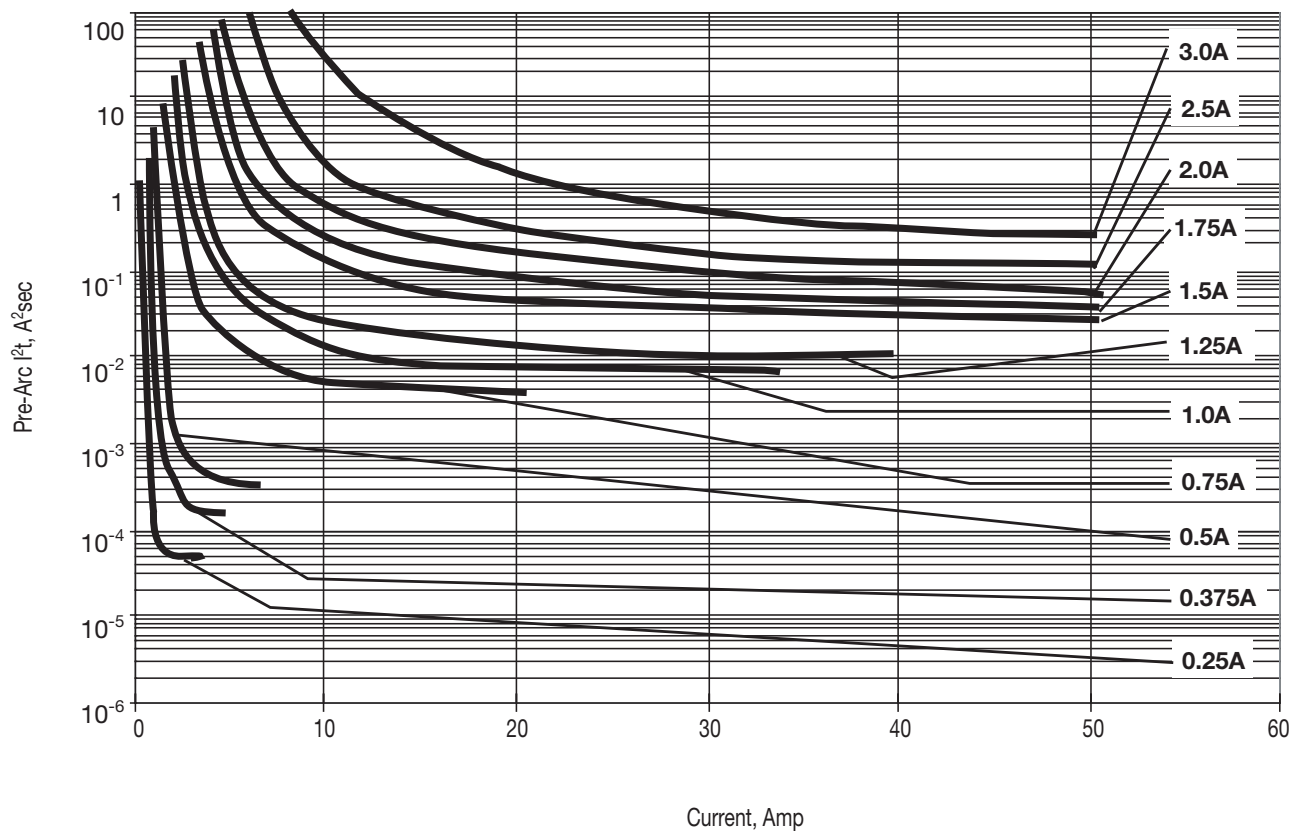

FUSE PRE-ARC JOULE INTEGRALS VS PRE-ARC TIME FOR TYPE F0603E (TYPICAL)

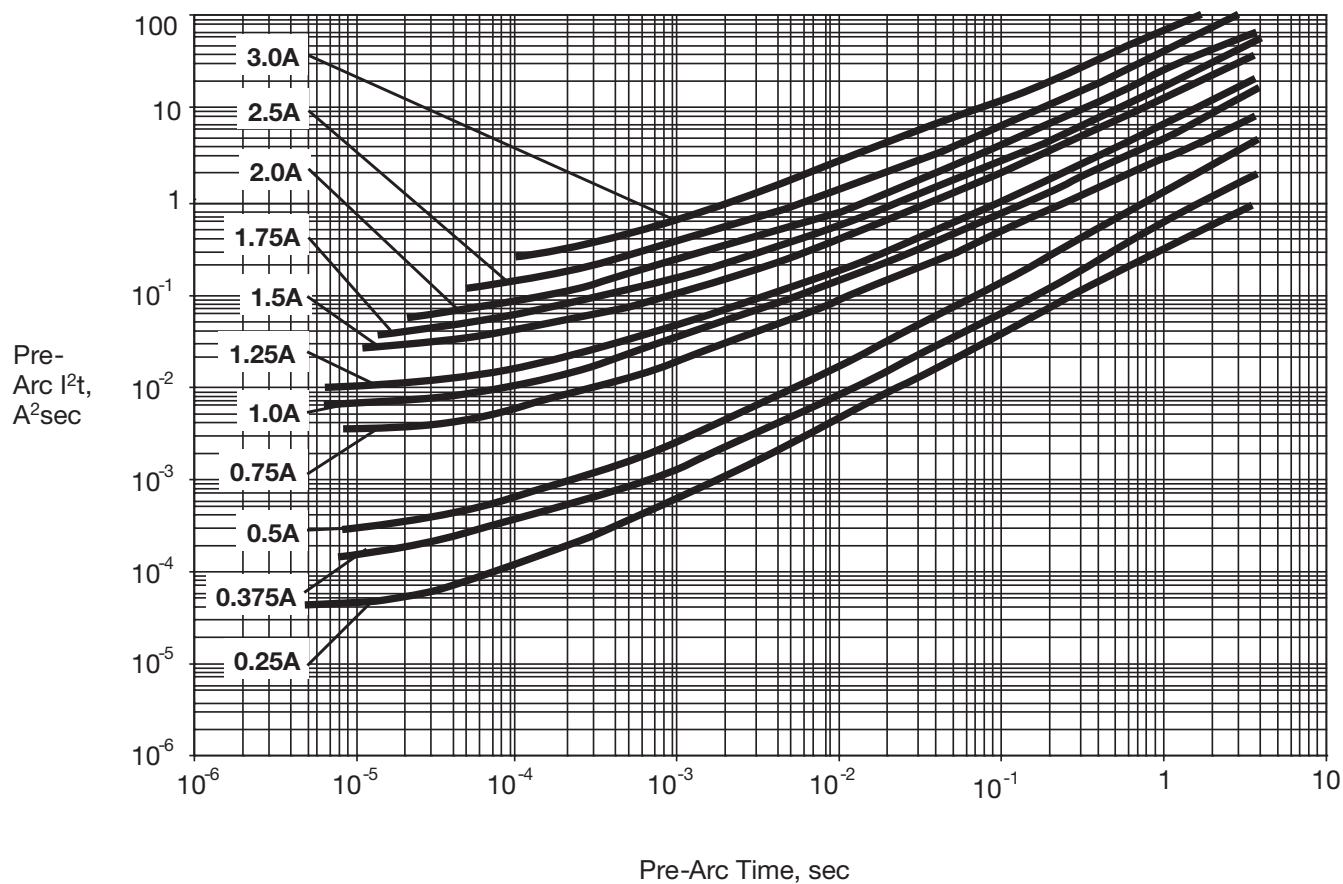

FUSE TIME - CURRENT CHARACTERISTICS FOR TYPE F0603C (TYPICAL)

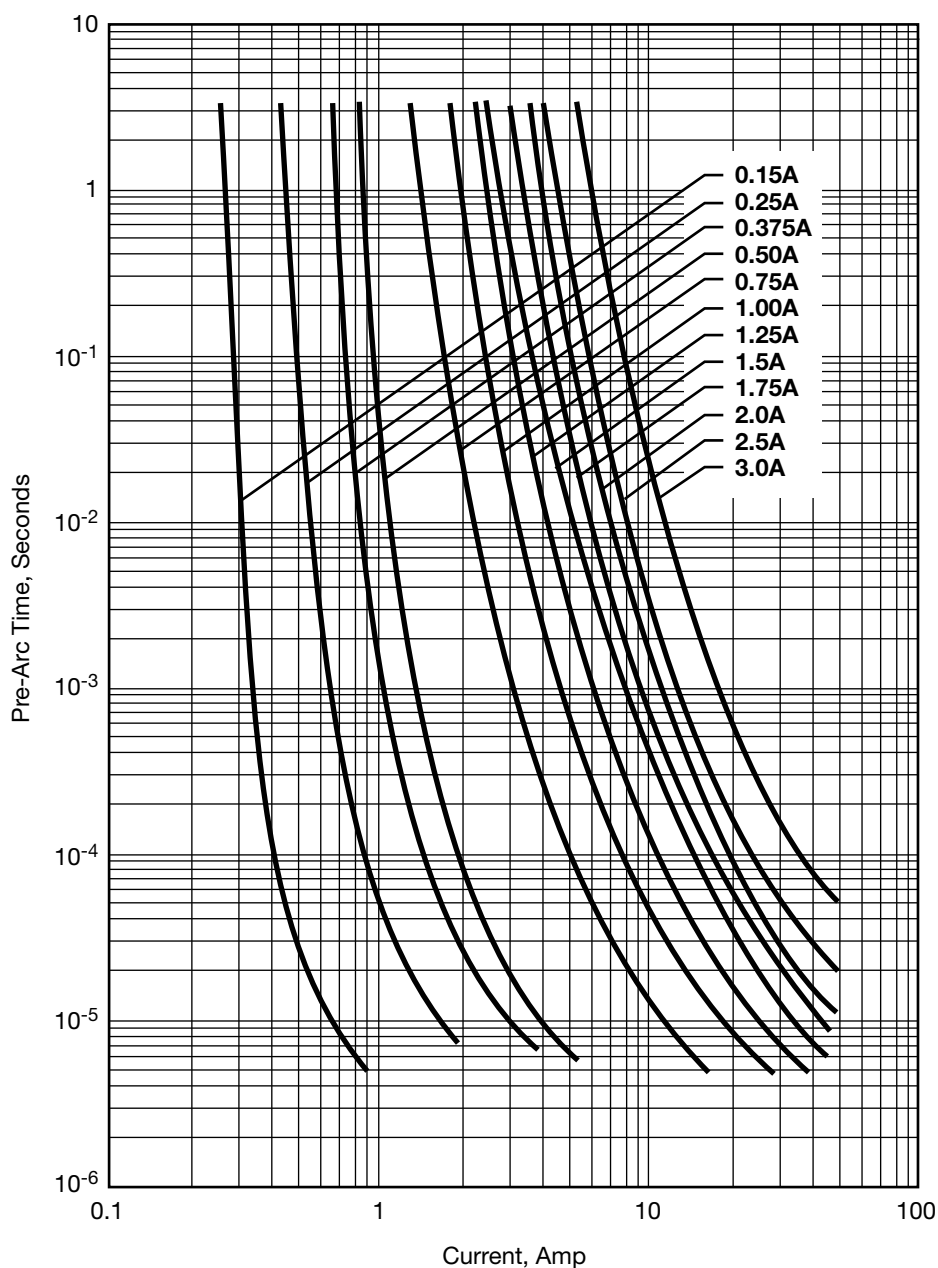

FUSE PRE-ARC JOULE INTEGRALS VS. CURRENT FOR TYPE F0603C (TYPICAL)

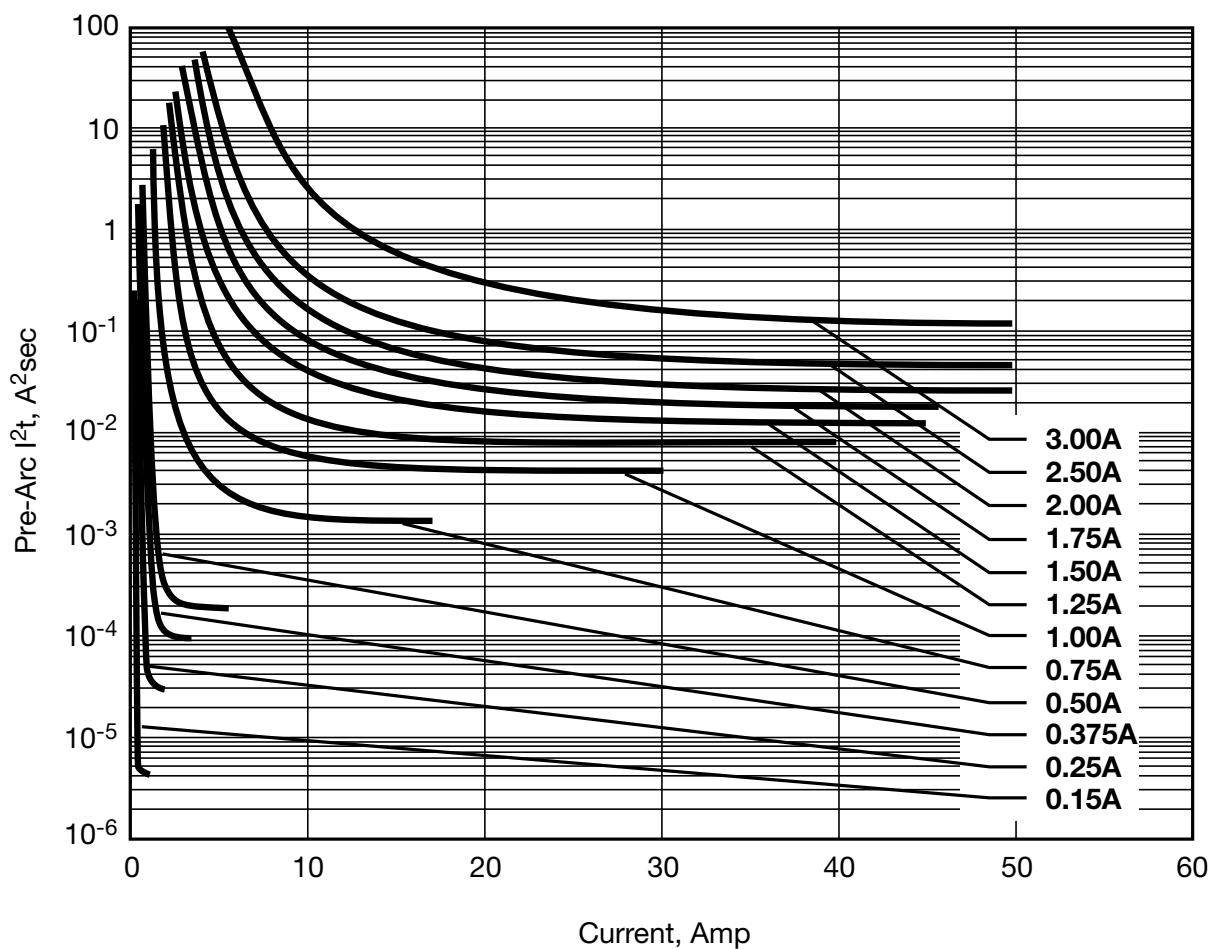

FUSE PRE-ARC JOULE INTEGRALS VS. PRE-ARC TIME FOR TYPE F0603C (TYPICAL)

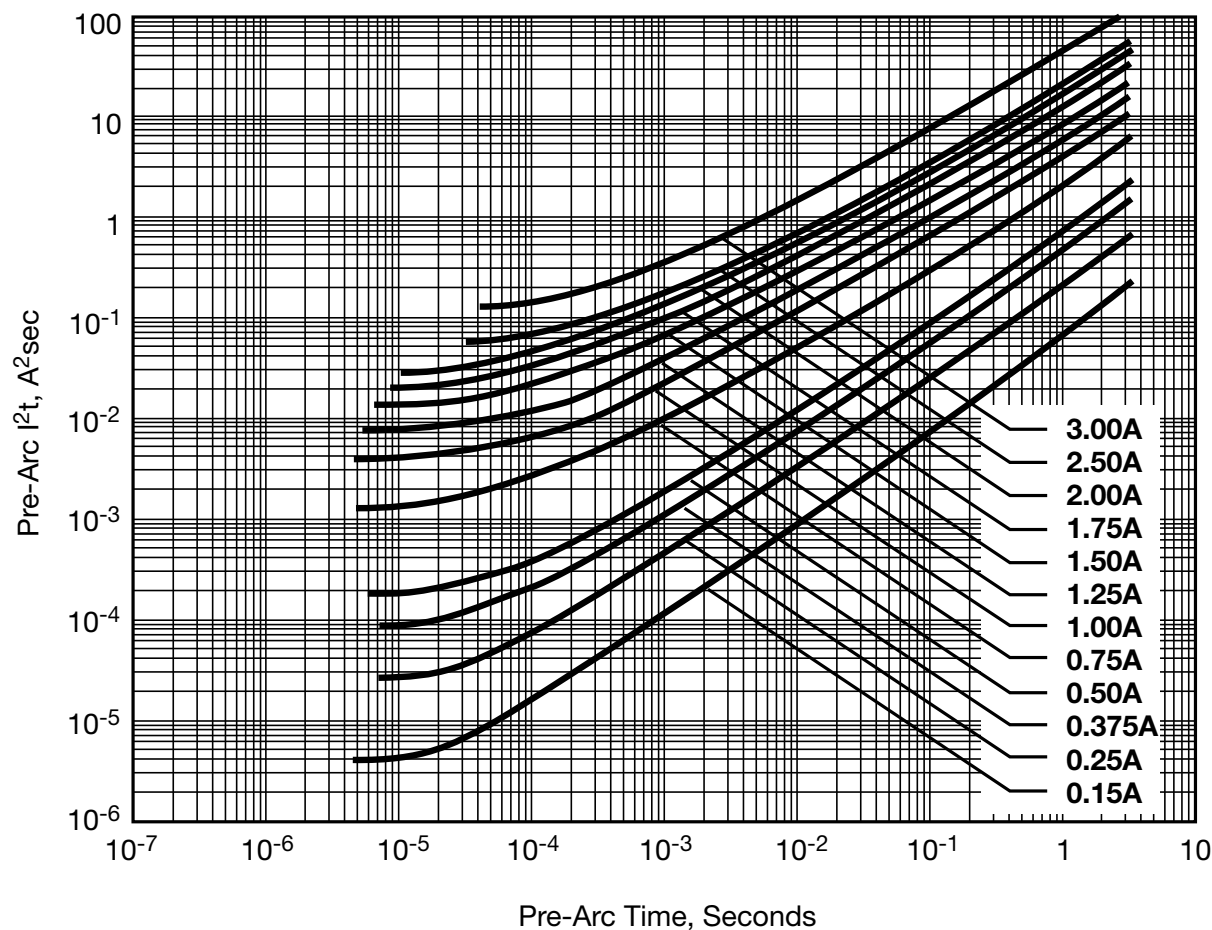

FUSE TIME - CURRENT CHARACTERISTICS FOR TYPES F0805B AND F1206B (TYPICAL)

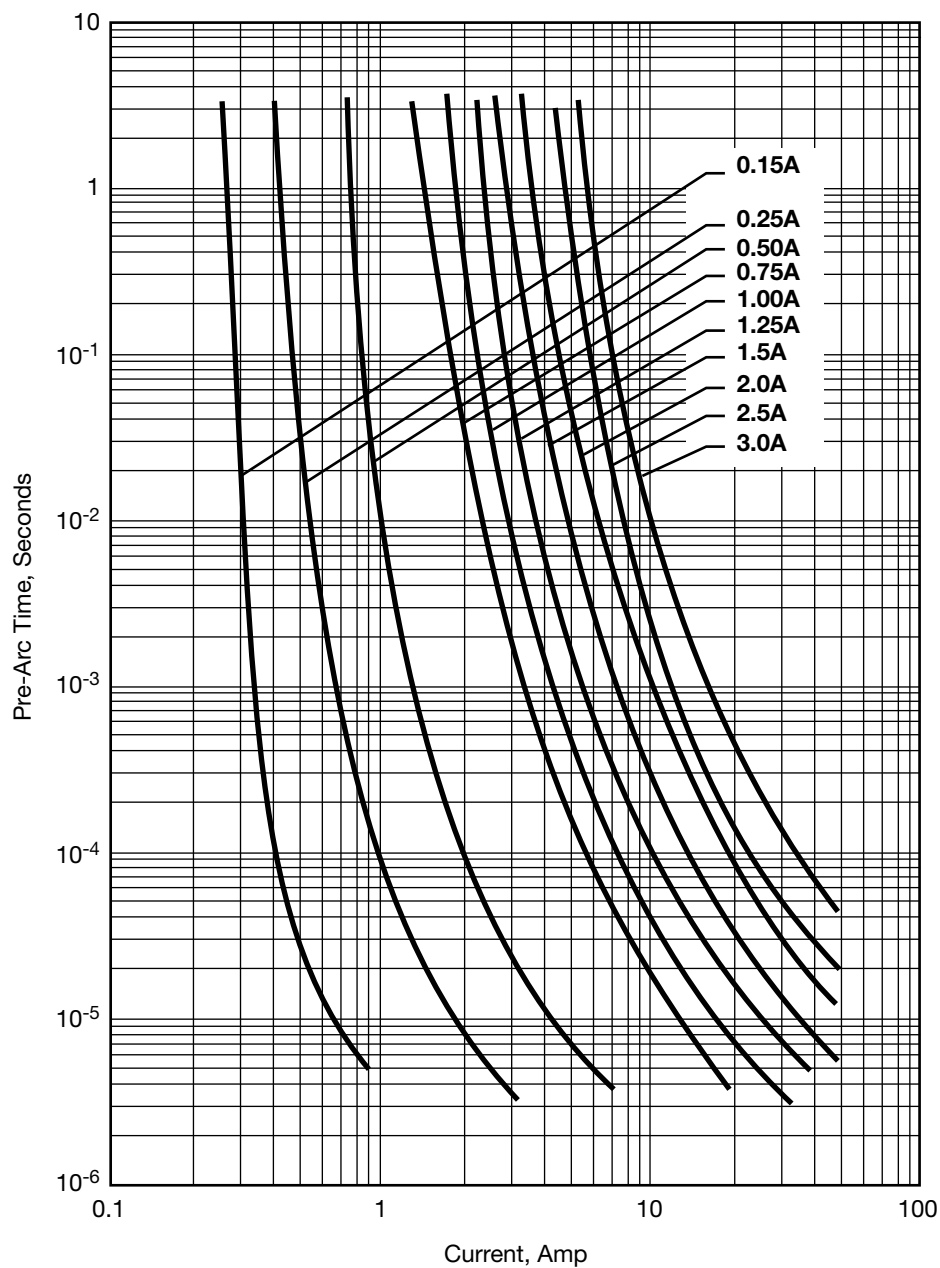

FUSE PRE-ARC JOULE INTEGRALS VS. CURRENT TIME FOR TYPES F0805B AND F1206B (TYPICAL)

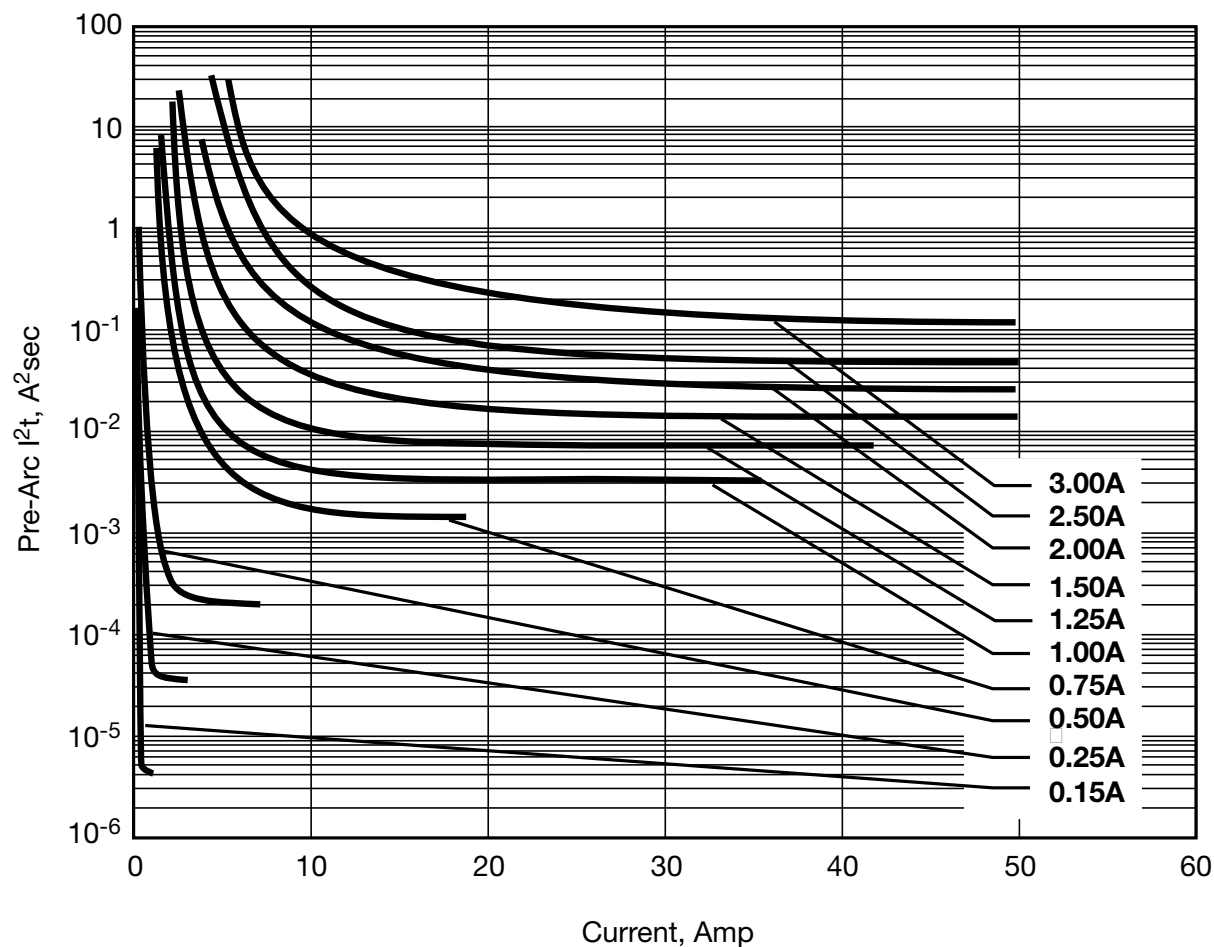

FUSE PRE-ARC JOULE INTEGRALS VS. PRE-ARC TIME FOR TYPES F0805B AND F1206B (TYPICAL)

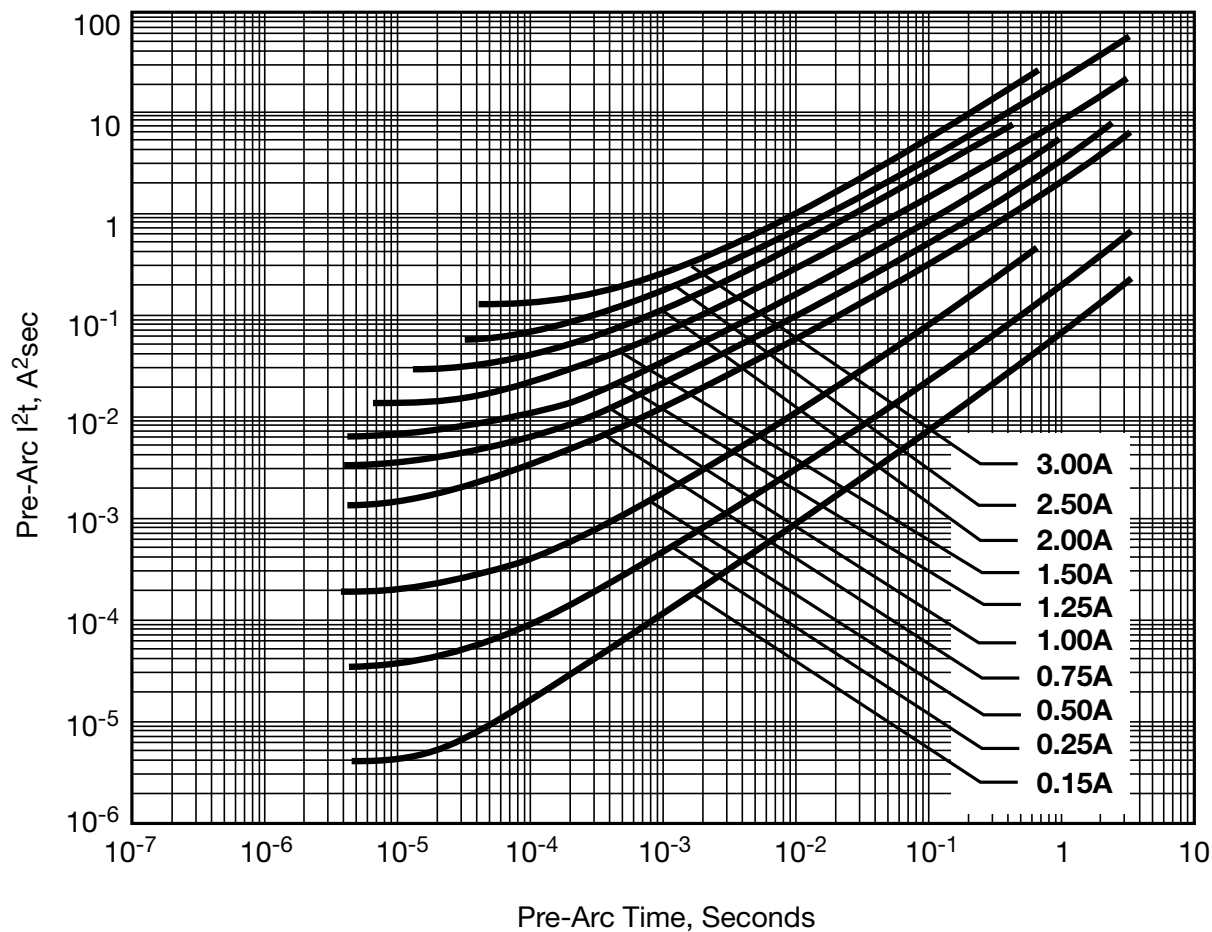

FUSE TIME - CURRENT CHARACTERISTICS FOR TYPE F0612D (TYPICAL)

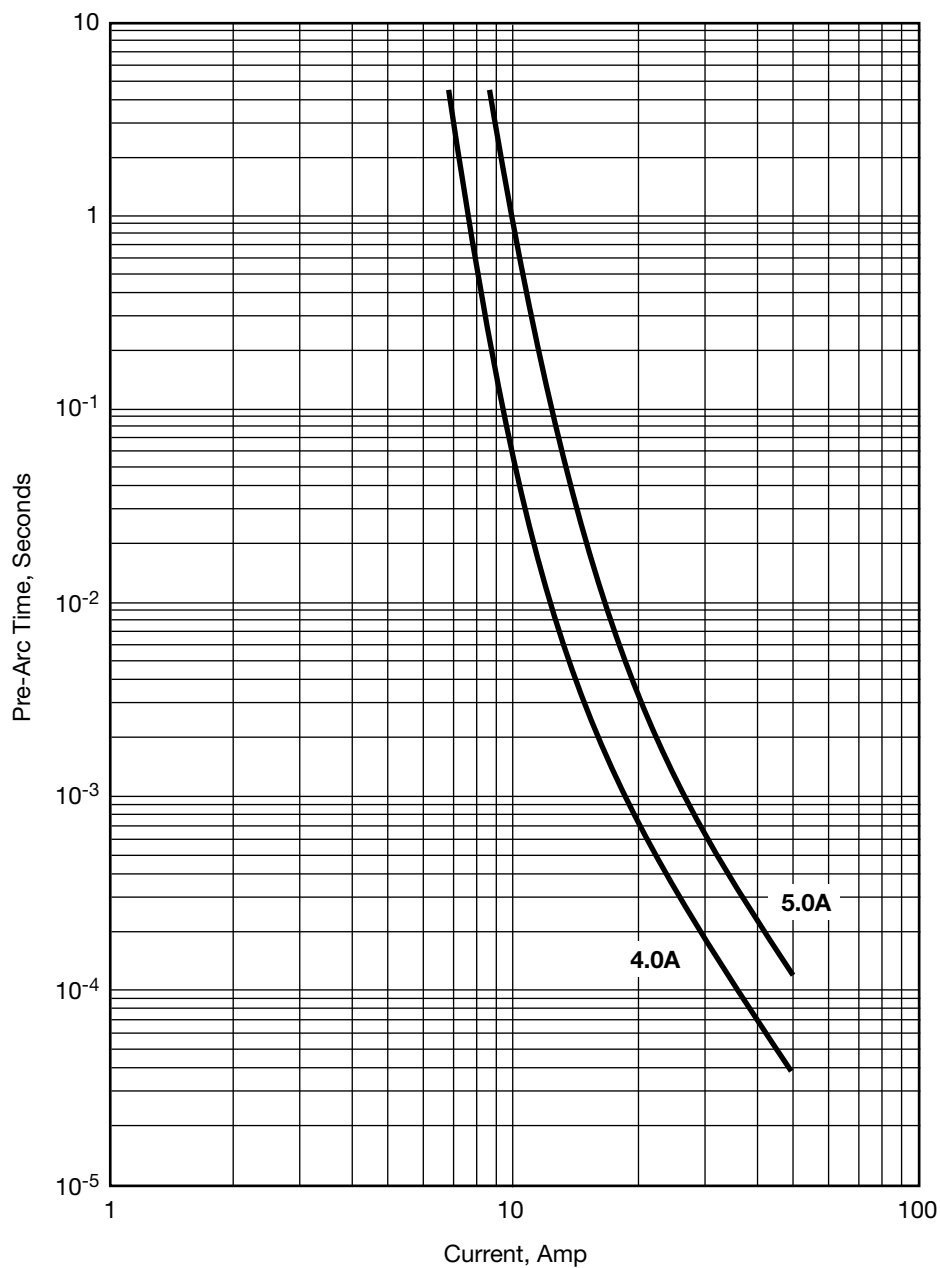

FUSE PRE-ARC JOULE INTEGRALS VS. PRE-ARC TIME FOR TYPE F0612D (TYPICAL)

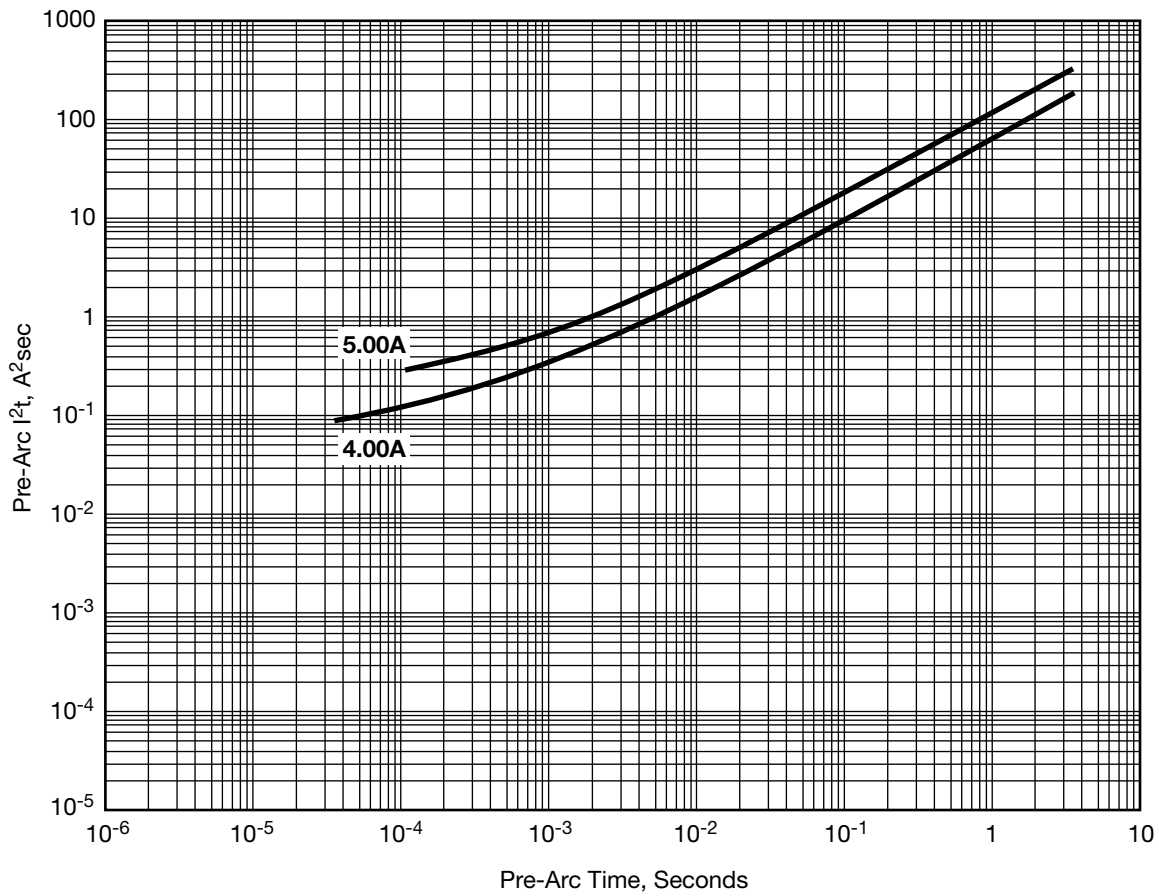

FUSE PRE-ARC JOULE INTEGRALS VS. CURRENT FOR TYPE F0612D (TYPICAL)

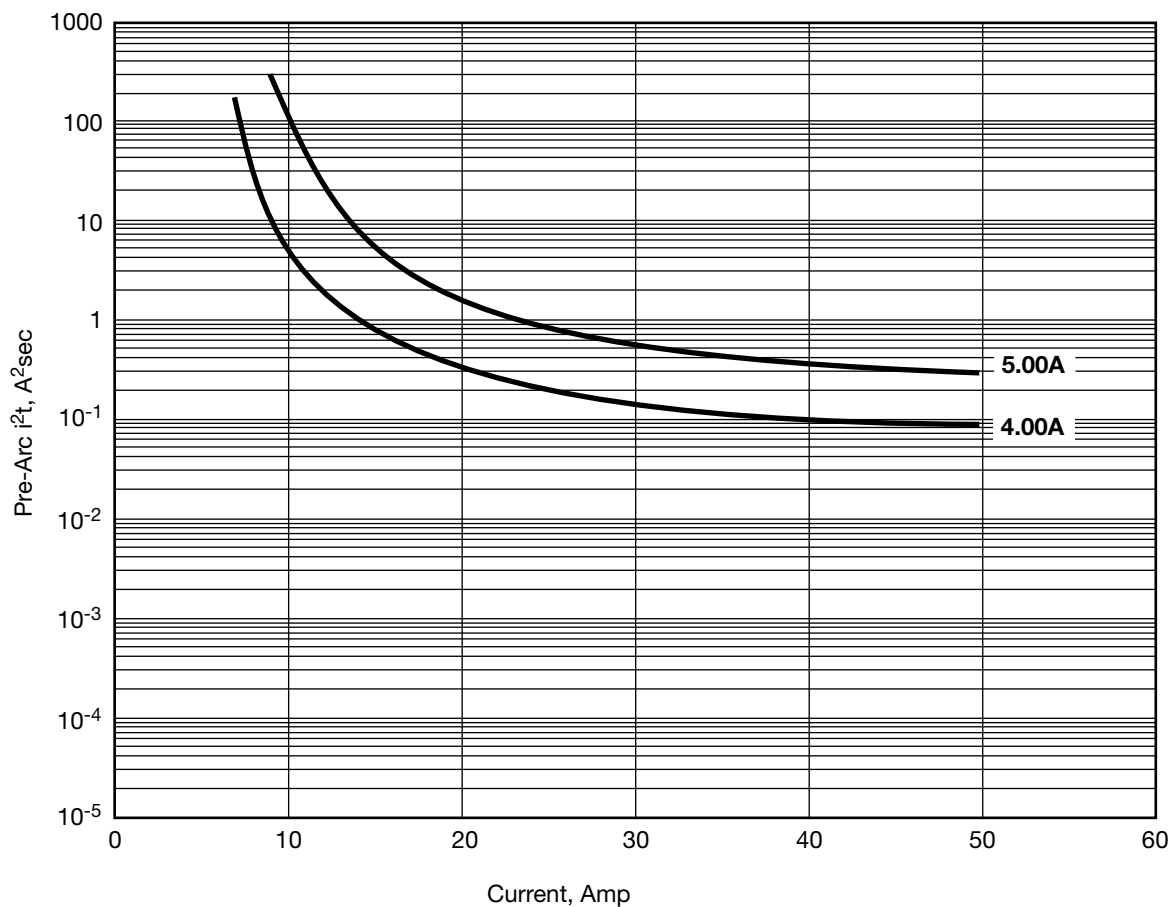

SMD Thin-Film Fuse

ELECTRICAL SPECIFICATIONS

Operating Temperature: -55°C to +125°C

Current carrying capacity at -55°C is 107% of rating;
at +25°C 100% of rating; at +85°C 93% of rating;
at +125°C 90% of rating.

Rated Voltage: 32V

Interrupting Rating: 50A

Insulation Resistance: >20MΩ guaranteed (after fusing at rated voltage)

1206

| Part Number | Current Rating A | Resistance @ 10% x I rated, 25°C Ω (Max.) | Voltage Drop @ 1 x I rated, 25°C mV (Max.) | Fusing Current (within 5 sec.) 25°C A | Pre-Arc I ² t @ 50A A ² - sec. |
|----------------|---------------------|---|--|---|--|
| F1206A0R20FWTR | 0.200 | 0.95 | 350 | 0.40 | 0.00002* |
| F1206A0R25FWTR | 0.250 | 0.75 | 280 | 0.50 | 0.00004* |
| F1206A0R37FWTR | 0.375 | 0.40 | 220 | 0.75 | 0.00006 |
| F1206A0R50FWTR | 0.500 | 0.35 | 220 | 1.00 | 0.0002 |
| F1206A0R75FWTR | 0.750 | 0.25 | 220 | 1.50 | 0.003 |
| F1206A1R00FWTR | 1.000 | 0.18 | 220 | 2.00 | 0.005 |
| F1206A1R25FWTR | 1.250 | 0.15 | 220 | 2.50 | 0.009 |
| F1206A1R50FWTR | 1.500 | 0.11 | 220 | 3.00 | 0.02 |
| F1206A1R75FWTR | 1.750 | 0.10 | 210 | 3.50 | 0.035 |
| F1206A2R00FWTR | 2.000 | 0.065 | 160 | 4.00 | 0.04 |

* Current is limited to less than 50A at 32V due to internal fuse resistance.

ENVIRONMENTAL CHARACTERISTICS

| Test | Conditions | Requirement |
|-----------------------------|--|---|
| Solderability | Components completely immersed in a solder bath at 235 ±5°C for 2 secs. | Terminations to be well tinned No visible damage |
| Leach Resistance | Completely immersed in a solder bath at 260 ±5°C for 60 secs. | Dissolution of termination ≤ 25% of area ΔR/R<10% |
| Storage | 12 months minimum with components stored in "as received" packaging. | Good solderability |
| Shear | Components mounted to a substrate. A force of 5N applied normal to the line joining the terminations and in a line parallel to the substrate. | No visible damage |
| Rapid Change of Temperature | Components mounted to a substrate. 5 cycles -55°C to +125°C. | No visible damage Δ R/R<10% |
| Vibration | Per Mil-Std-202F Method 201A and Method 204D Condition D. | No visible damage ΔR/R<10% |
| Load Life | 25°C, I rated, 20,000 hrs. | No visible damage ΔR/R<10% |

*Not recommended for new designs, please consult factory.

FUSE TIME - CURRENT CHARACTERISTICS FOR SIZE 1206 (TYPICAL)

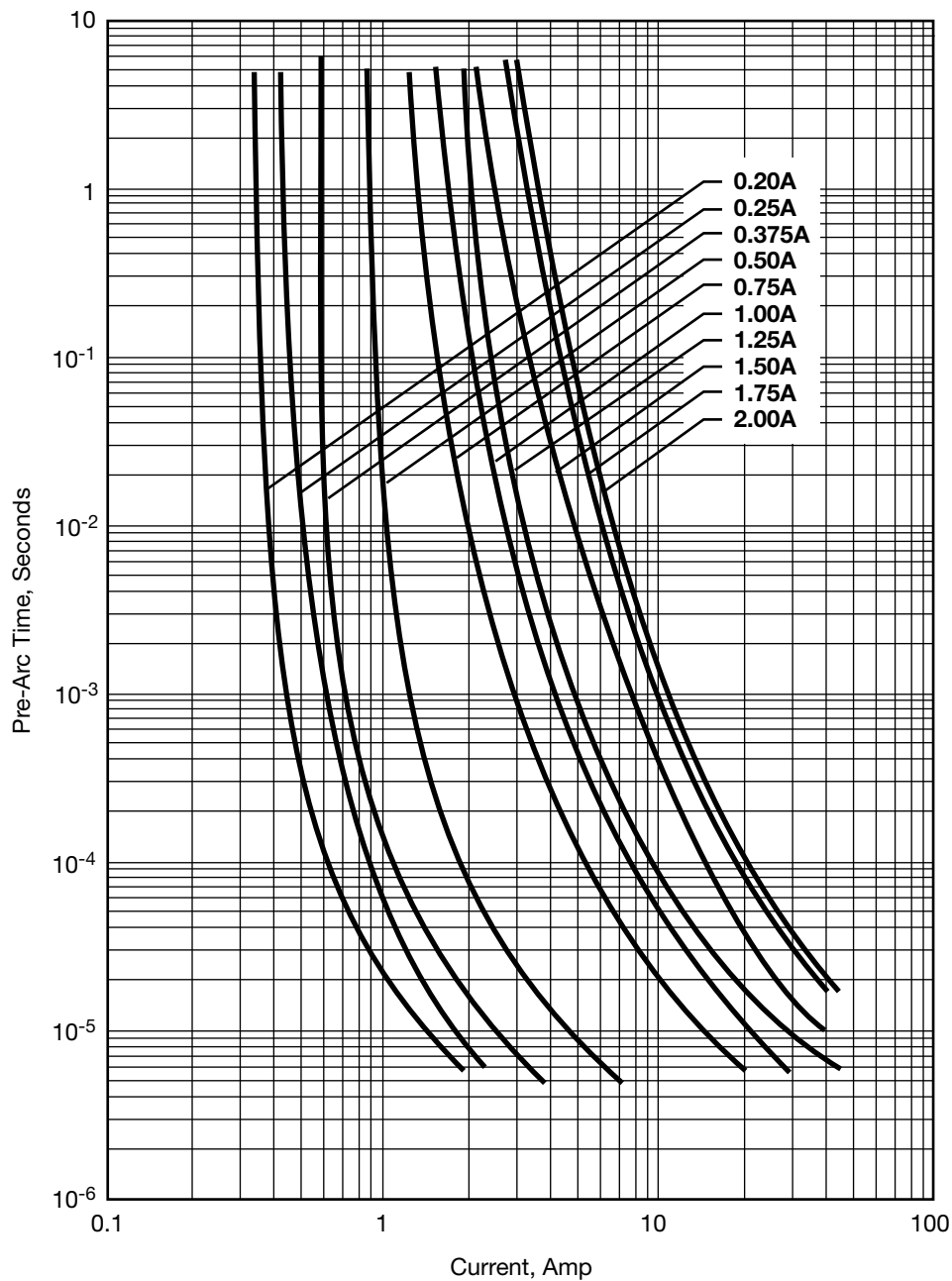

FUSE PRE-ARC JOULE INTEGRALS VS. CURRENT FOR SIZE 1206 (TYPICAL)

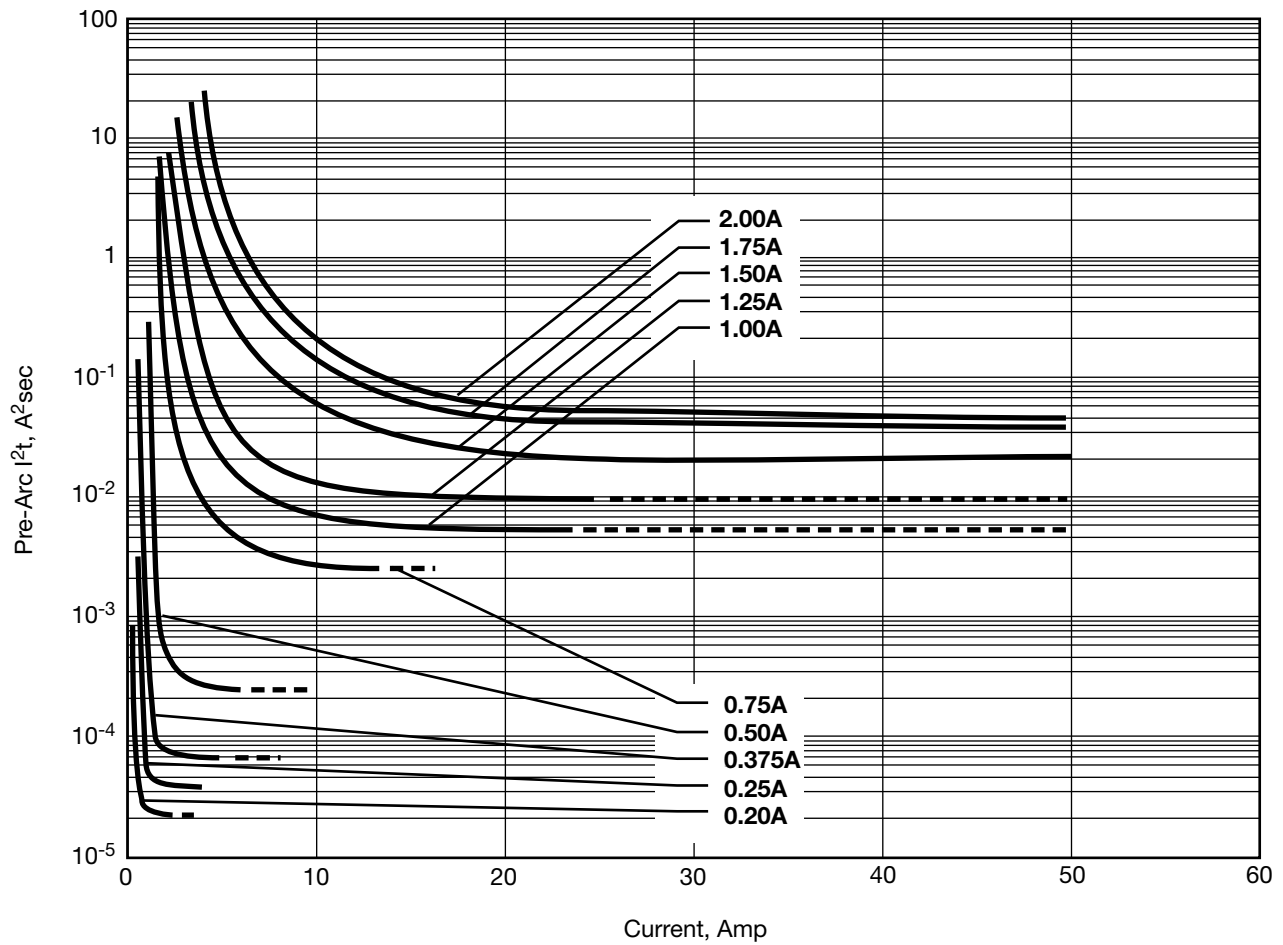

FUSE PRE-ARC JOULE INTEGRALS VS. PRE-ARC TIME FOR SIZE 1206 (TYPICAL)

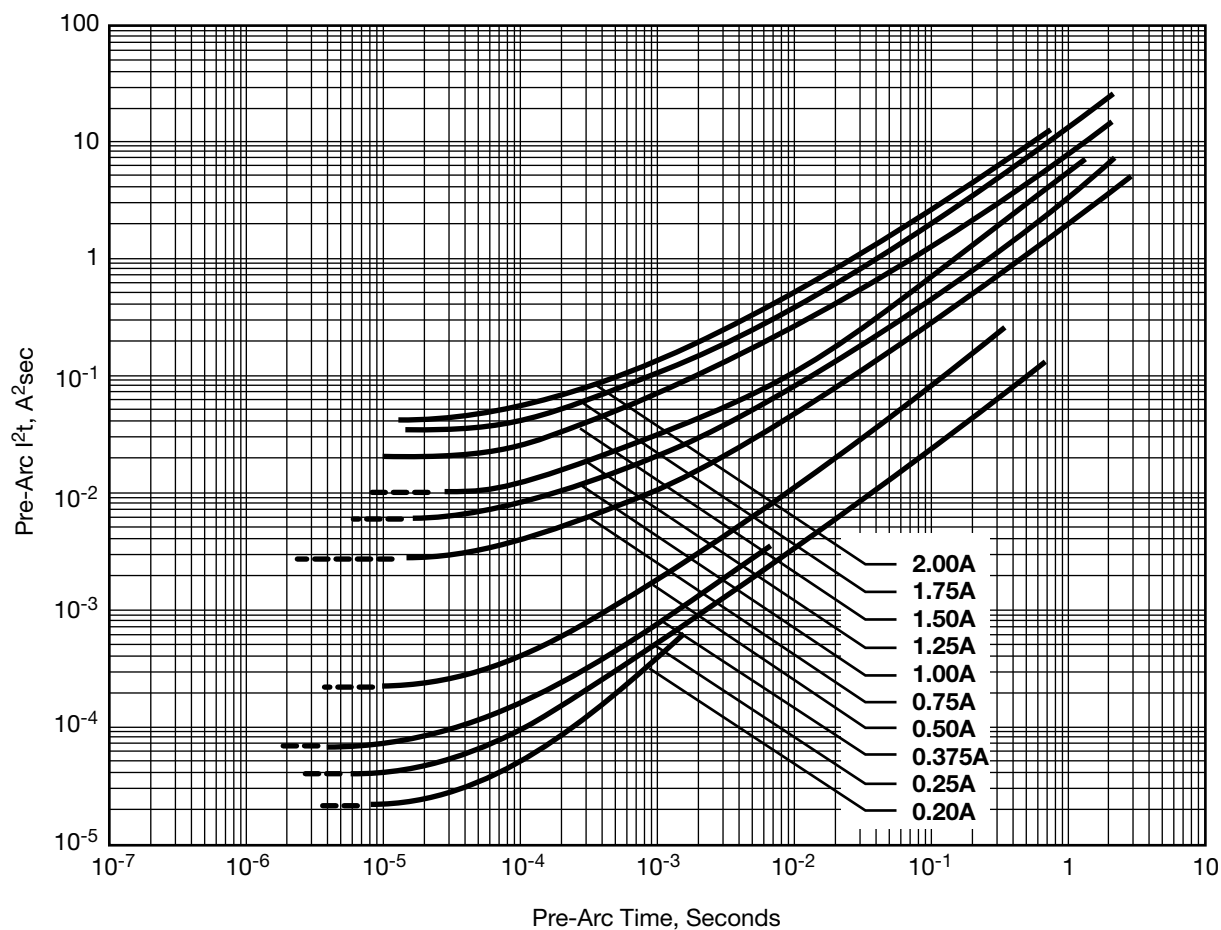

QUALITY & RELIABILITY

Accu-Guard® series of fuses is based on established thin-film technology and materials used in the semiconductor industry.

- In-line Process Control:** This program forms an integral part of the production cycle and acts as a feedback system to regulate and control production processes. The test procedures, which are integrated into the production process, were developed after long research and are based on the highly developed semiconductor industry test procedures and equipment. These measures help AVX/Kyocera to produce a consistent and high yield line of products.
- Final Quality Inspection:** Finished parts are tested for standard electrical parameters and visual/mechanical characteristics. Each production lot is 100% evaluated for electrical resistance. In addition, each production lot is evaluated on a sample basis for:
 - Insulation resistance (post fusing)
 - Blow time for 2 x rated current
 - Endurance test: 125°C, rated current, 4 hours

HANDLING AND SOLDERING

SMD chips should be handled with care to avoid damage or contamination from perspiration and skin oils. The use of plastic tipped tweezers or vacuum pick-ups is strongly recommended for individual components. Bulk handling should ensure that abrasion and mechanical shock are minimized. For automatic equipment, taped and reeled product is the ideal medium for direct presentation to the placement machine.

CIRCUIT BOARD TYPE

All flexible types of circuit boards may be used (e.g. FR-4, G-10).

For other circuit board materials, please consult factory.

WAVE SOLDERING

Dimensions: millimeters (inches)

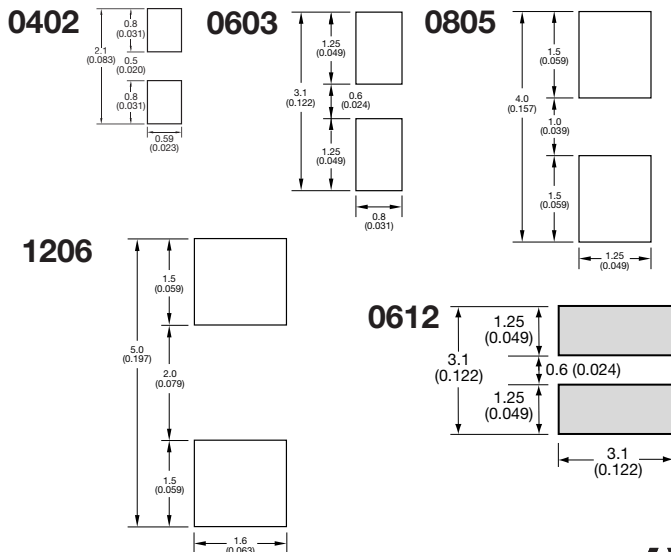

COMPONENT PAD DESIGN

Component pads must be designed to achieve good joints and minimize component movement during soldering.

Pad designs are given below for both wave and reflow soldering.

The basis of these designs are:

- Pad width equal to component width. It is permissible to decrease this to as low as 85% of component width but it is not advisable to go below this.
- Pad overlap 0.5mm.
- Pad extension 0.5mm for reflow. Pad extension about 1.0mm for wave soldering.

PREHEAT & SOLDERING

The rate of preheat in production should not exceed 4°C/second. It is recommended not to exceed 2°C/second.

Temperature differential from preheat to soldering should not exceed 150°C.

For further specific application or process advice, please consult AVX.

HAND SOLDERING & REWORK

Hand soldering is permissible. Preheat of the PCB to 100°C is required. The most preferable technique is to use hot air soldering tools. Where a soldering iron is used, a temperature controlled model not exceeding 30 watts should be used and set to not more than 260°C. Maximum allowed time at temperature is 1 minute.

COOLING

After soldering, the assembly should preferably be allowed to cool naturally. In the event of assisted cooling, similar conditions to those recommended for preheating should be used.

REFLOW SOLDERING

Dimensions: millimeters (inches)

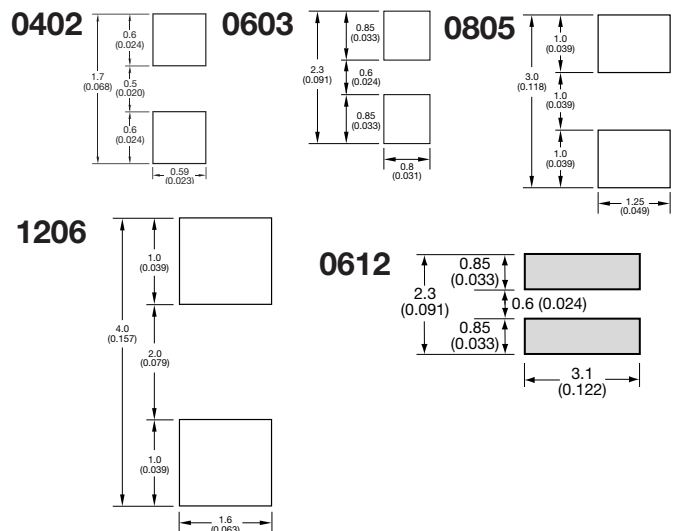

RECOMMENDED SOLDERING PROFILES

IR REFLOW

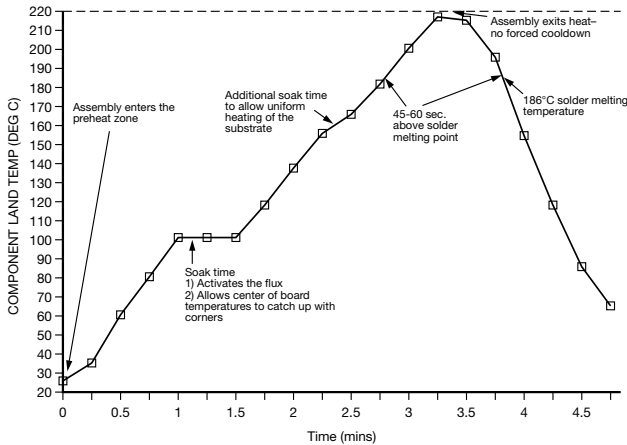

CLEANING RECOMMENDATIONS

Care should be taken to ensure that the devices are thoroughly cleaned of flux residues, especially the space beneath the device. Such residues may otherwise become conductive and effectively offer a lousy bypass to the device. Various recommended cleaning conditions (which must be optimized for the flux system being used) are as follows:

- Cleaning liquids i-propanol, ethanol, acetylacetone, water, and other standard PCB cleaning liquids.
- Ultrasonic conditions . . . power – 20w/liter max. frequency – 20kHz to 45kHz.
- Temperature 80°C maximum (if not otherwise limited by chosen solvent system).
- Time5 minutes max.

WAVE SOLDERING

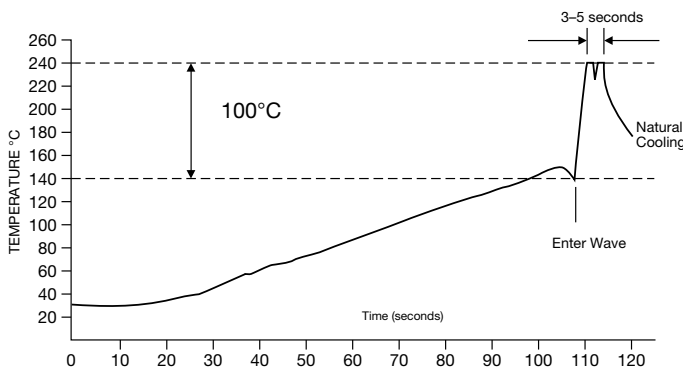

STORAGE CONDITIONS

Recommended storage conditions for Accu-Guard® prior to use are as follows:

- Temperature 15°C to 35°C
- Humidity ≤65%
- Air Pressure 860mbar to 1060mbar

VAPOR PHASE

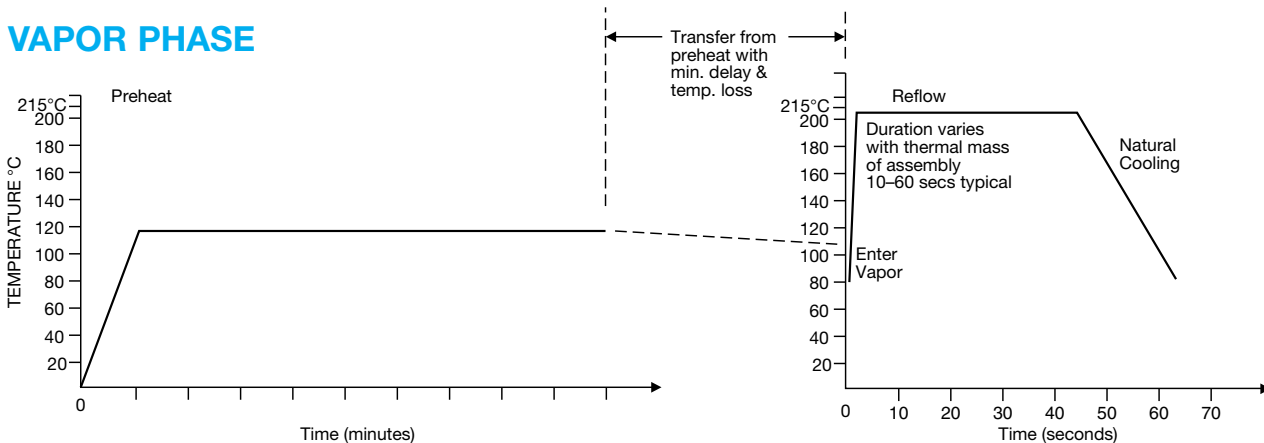

SMD Thin-Film Fuse

PACKAGING

Automatic Insertion Packaging

Tape & Reel: All tape and reel specifications are in compliance with EIA 481-1

- 8mm carrier
- Reeled quantities: Reels of 3,000 or 10,000 pieces
(for F0402: 5,000 or 20,000 pieces)

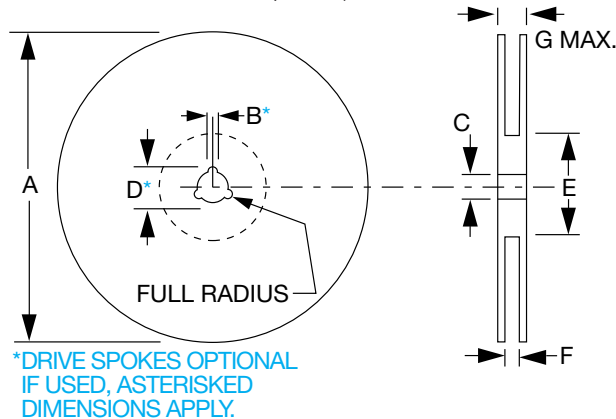

REEL DIMENSIONS: millimeters (inches)

| A(1) | B* | C | D* | E | F | G |
|------------------------------|--------------------------|-----------------------------|---------------------------|-------------------------|------------------------------|---------------------------|
| 180 ± 1.0 (7.087 ± 0.039) | 1.5 min. (0.059 min.) | 13 ± 0.2 (0.512 ± 0.008) | 20.2 min. (0.795 min.) | 50 min. (1.969 min.) | 9.4 ± 1.5 (0.370 ± 0.050) | 14.4 max. (0.567 max.) |

Metric dimensions will govern.
Inch measurements rounded for reference only.
(1) 330mm (13 inch) reels are available.

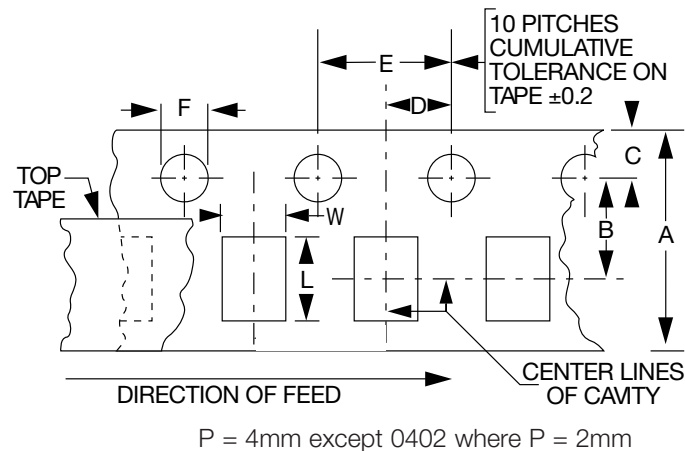

CARRIER DIMENSIONS: millimeters (inches)

| A | B | C | D | E | F |
|------------------------------|-------------------------------|-------------------------------|-------------------------------|------------------------------|---|
| 8.0 ± 0.3 (0.315 ± 0.012) | 3.5 ± 0.05 (0.138 ± 0.002) | 1.75 ± 0.1 (0.069 ± 0.004) | 2.0 ± 0.05 (0.079 ± 0.002) | 4.0 ± 0.1 (0.157 ± 0.004) | 1.5 ^{+0.1} _{-0.0} (0.059 ^{+0.004} _{-0.000}) |

Note: The nominal dimensions of the component compartment (W,L) are derived from the component size.

Note: AVX reserves the right to change the information published herein without notice.

HOW TO CHOOSE THE CORRECT ACCU-GUARD® FUSE FOR CIRCUIT PROTECTION

Correct choice of an Accu-Guard® fuse for a given application is fairly straightforward. The factor of pre-arc I^2t , however, requires clarification. The proper design for pre-arc I^2t is presented by way of example.

DESIGN PARAMETERS

1. Operating Temperature

The Accu-Guard® is specified for operation in the temperature range of -55°C to $+125^{\circ}\text{C}$. Note, however, that fusing current is sensitive to temperature. This means that the fuse must be derated or uprated at circuit temperatures other than 25°C :

| Environmental Temperature | Accu-Guard® Current Carrying Capacity* | | | | |
|--|--|------------------------|----------------------|-------------------|-------------------|
| | F0402E, F0603E | F0805B, F1206A, F1206B | F0805B 2.50A & 3.00A | F0603C | F0612D |
| -55°C to -11°C | $1.07 \times I_R$ | $1.07 \times I_R$ | $1.07 \times I_R$ | $1.07 \times I_R$ | $1.07 \times I_R$ |
| -10°C to 60°C | I_R | I_R | I_R | I_R | I_R |
| 61°C to 100°C | $0.85 \times I_R$ | $0.93 \times I_R$ | $0.90 \times I_R$ | $0.90 \times I_R$ | $0.80 \times I_R$ |
| 101°C to 125°C | $0.80 \times I_R$ | $0.90 \times I_R$ | $0.90 \times I_R$ | $0.75 \times I_R$ | $0.75 \times I_R$ |

*As a function of nominal rated current, I_R .

2. Circuit Voltage

Maximum Voltage: Accu-Guard® is specified for circuits of up to rated voltage. Accu-Guard® will successfully break currents at higher voltages as well, but over voltage may crack the fuse body.

Minimum Voltage: Accu-Guard® cannot be used in circuits with voltage of about 0.5V and less. The internal resistance of the fuse will limit the fault current to a value which will prevent reliable actuation of the fuse ($<2 \times$ rated current).

3. Maximum Fault Current

Accu-Guard® is fully tested and specified for fault currents up to 50A. Accu-Guard® will successfully break currents above 50A, but such over current may crack the fuse body or damage the fuse terminations.

4. Steady-State Current

The Accu-Guard® current rating is based on IEC Specification 127-3. In accordance with this international standard, Accu-Guard® is specified to operate at least 4 hours at rated current without fusing (25°C). Engineering tests have shown that F0805B and F1206A/B Accu-Guard® will in fact operate at least 20,000 hours at rated current without fusing (25°C).

5. Switch-on and Other Pulse Current

Many circuits generate a large current pulse when initially connected to power. There are also circuits which are subject to momentary current pulses due to external sources; telephone line cards which are subject to lightning-induced pulses are one example. These current pulses must be passed by the fuse **without** causing actuation. These pulses may be so large that they are the determining factor for choosing the Accu-Guard® current rating; not necessarily steady state current.

In order to design for current pulses, the concept of fuse pre-arc Joule integral, I^2t , must be understood. Fuse current rating is defined by the requirement that $2 \times I_R$ will cause actuation in <5 seconds. This rating does not indicate how the fuse will react to very high currents of very short duration. Rather, the fusing characteristic at very high currents is specified by I^2t -t curves (or I^2t -I).

I^2t expresses the amount of energy required to actuate the fuse. Total I^2t expresses the total energy which will be passed by the fuse until total cessation of current flow. Pre-arc I^2t expresses that energy required to cause large irreversible damage to the fuse element (Total $I^2t =$ pre-arc $I^2t +$ arc I^2t). If the Joule integral of the switch-on pulse is larger than the fuse pre-arc I^2t , nuisance actuation will occur.

In order to choose the proper Accu-Guard® current rating for a given application, it is necessary to calculate the I^2t Joule integral of the circuit switch-on and other current pulses and compare them to the Accu-Guard® I^2t -t curves. An Accu-Guard® fuse must be chosen such that the pulse I^2t is no more than 50% of the pre-arc I^2t of the prospective fuse.

Pre-arc I^2t of the Accu-Guard® fuses is well characterized; I^2t -t and I^2t -I graphs are in this catalog. The problem is calculating the I^2t of the circuit current pulses. This concept is not familiar to most engineers. Correct calculation of pulse Joule integral and subsequent choice of Accu-Guard® current rating is illustrated by way of the attached examples.

DESIGNING FOR CURRENT PULSE SITUATIONS

1. Sine wave current pulse

The Joule integral for sine wave pulse is

$$[(I_{max.})^2 \times t]/2,$$

see Fig. 1a.

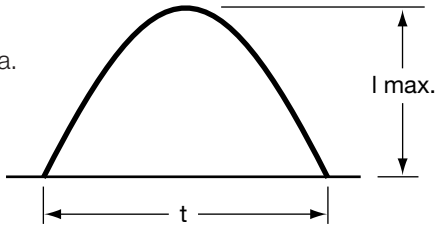

Fig. 1a. Sine wave pulse parameters for Joule integral calculation, example #1.

Thus, for the current pulse in Figure 1b, the Joule integral is $[(4.8A)^2 \times 7.7 \times 10^{-6} \text{ sec}]/2 = 8.9 \times 10^{-5} \text{ A}^2 \text{ sec}$.

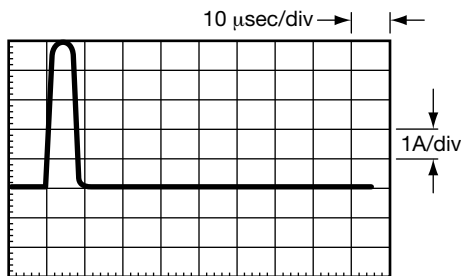

Fig. 1b. Sine wave pulse, example #1.

The pulse duration is 7.7μsec. We must find a fuse that can absorb at least $8.9 \times 10^{-5} \times 2 = 1.8 \times 10^{-4} \text{ A}^2 \text{ sec}$ Joule integral within 7.7 μsec without actuation. According to the I^2t graph on page 6, pre-arcing Joule integral is $2.3 \times 10^{-4} \text{ A}^2 \text{ sec}$ for the 0.5A fuse, which is slightly more than needed. The next lower rating (0.375A), has only $6 \times 10^{-5} \text{ A}^2 \text{ sec}$, which is not enough. Therefore, 0.5A fuse should be chosen for this application, see Figure 1c.

FUSE PRE-ARCING JOULE INTEGRALS vs. PRE-ARCING TIME

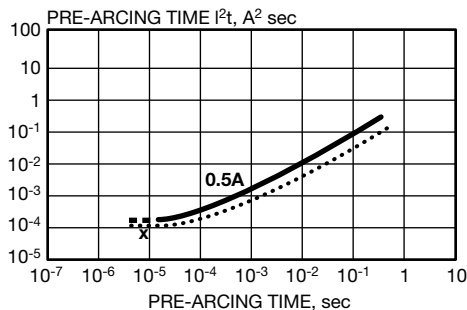

Fig. 1c. Choice of 0.5A fuse, example #1.

- Pre-arcing I^2t
- Maximum I^2t design rule
- x I^2t for sample current pulse

2. Triangular current pulse

The Joule integral for triangular pulse is

$$[(I_{max.})^2 \times t]/3,$$

see Fig. 2a.

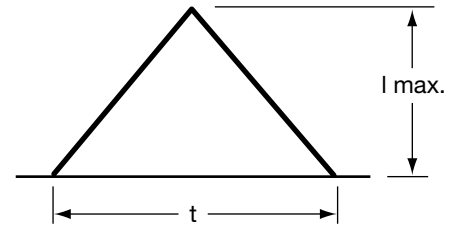

Fig. 2a. Triangular pulse parameters for Joule integral calculation, example #2.

Thus, for the current pulse in Figure 2b, the Joule integral is $[(1.5A)^2 \times 3 \times 10^{-3} \text{ sec}]/3 = 2.25 \times 10^{-3} \text{ A}^2 \text{ sec}$.

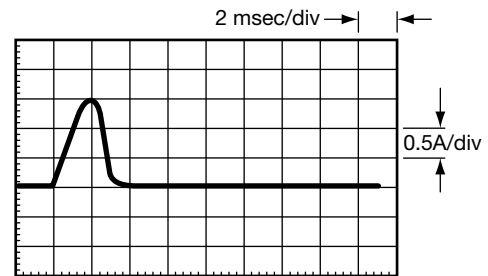

Fig. 2b. Triangular pulse, example #2.

The pulse duration is 3 msec. In the I^2t graph on page 6, pre-arcing Joule integral for 3 msec pulse is $4 \times 10^{-3} \text{ A}^2 \text{ sec}$ for the 0.5A fuse (not enough) and 2×10^{-2} for the 0.75A fuse (more than enough). Therefore, 0.75A fuse should be chosen for this application, see Figure 2c.

FUSE PRE-ARCING JOULE INTEGRALS vs. PRE-ARCING TIME

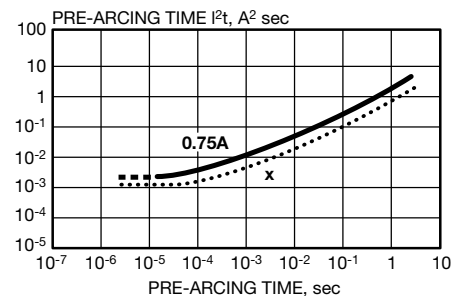

Fig. 2c. Choice of 0.75A fuse, example #2.

- Pre-arcing I^2t
- Maximum I^2t design rule
- x I^2t for sample switch-on pulse

DESIGNING FOR CURRENT PULSE SITUATIONS (CONT.)

3. Trapezoidal current pulse

The Joule integral for a trapezoidal pulse is

$$\left[(I_{\min.})^2 + I_{\min.} \times (I_{\max.} - I_{\min.}) + \frac{(I_{\max.} - I_{\min.})^2}{3} \right] \times t,$$

see Fig. 3a.

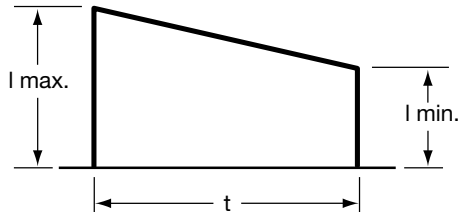

Fig. 3a. Trapezoidal pulse parameters for Joule integral calculation, example #3.

Thus, for current pulse in Figure 3b, the Joule integral is:

$$\left\{ (0.56A)^2 + 0.56A \times (1A - 0.56A) + \frac{(1A - 0.56A)^2}{3} \right\} \times 3 \times 10^{-3}s = 1.9 \times 10^{-3}A^2sec.$$

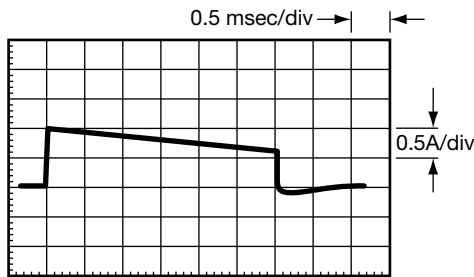

Fig. 3b. Trapezoidal pulse, example #3.

According to the I^2t graph on page 6, the 0.5A fuse should be chosen for this application, see Figure 3c.

FUSE PRE-ARCING JOULE INTEGRALS vs. PRE-ARCING TIME

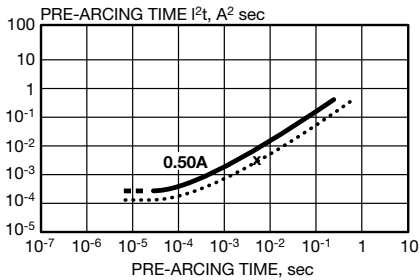

Fig. 3c. Choice of 0.5A fuse, example #3.

- Pre-arcing I^2t
- Maximum I^2t design rule
- X I^2t for sample switch-on pulse

4. Lightning strike

A lightning strike pulse is shown in Figure 4a. After an initial linear rise, the current declines exponentially.

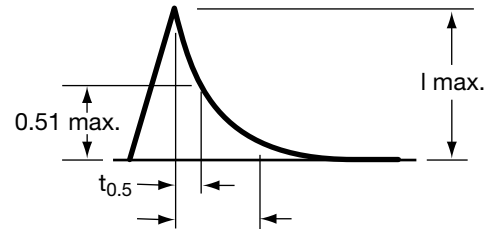

Fig. 4a. Lightning pulse parameters for Joule integral calculation, example #4.

Joule integral for the linear current rise is calculated as for a triangular pulse, see example #2.

The Joule integral for the exponential decline is

$$I_{\max.}^2 \times t_{0.5} \times (-1/2 \ln 0.5) = 0.72 I_{\max.}^2 \times t_{0.5}$$

Thus, for the sample lightning strike pulse in Figure 4b, the total Joule integral is:

$$(25A)^2 \times 2 \times 10^{-6}sec/3 + 0.72 \times (25A)^2 \times 10 \times 10^{-6}sec = 4.92 \times 10^{-3}A^2sec.$$

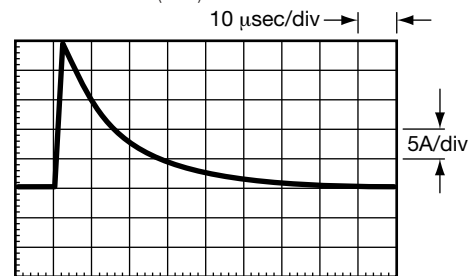

Fig. 4b. Lightning strike pulse, example #4.

For practical calculations, the duration of exponential decline may be assumed to be $3t_{0.5}$, because within this time 98.5% of the pulse energy is released. Thus, the total pulse duration in this example is 30 μ sec, and the 1.25A fuse should be chosen for this application, see Figure 4c.

FUSE PRE-ARCING JOULE INTEGRALS vs. PRE-ARCING TIME

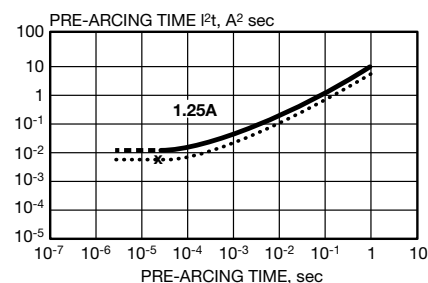

Fig. 4c. Choice of 0.5A fuse, example #4.

- Pre-arcing I^2t
- Maximum I^2t design rule
- X I^2t for sample switch-on pulse

DESIGNING FOR CURRENT PULSE SITUATIONS (CONT.)

5. Complex current pulse

If the pulse consists of several waveforms, all of them should be evaluated separately, and then the total Joule integral should be calculated as well.

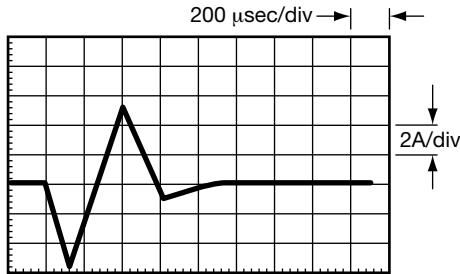

Fig. 5a. Complex pulse, example #5.

In Figure 5a, the Joule integral for the first triangle is $[(4.67A)^2 \times 294 \times 10^{-6} \text{sec}] / 3 = 2.14 \times 10^{-3} \text{ A}^2\text{sec}$ and 0.75A fuse should meet this condition, see Figure 5b.

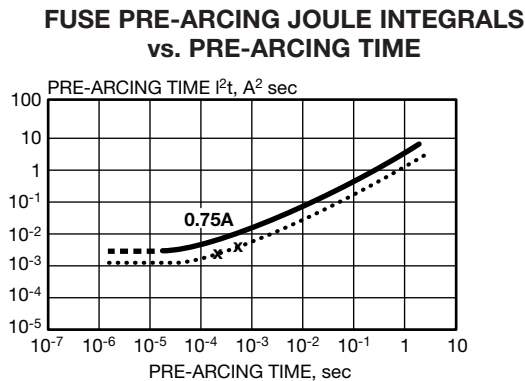

Fig. 5b. Choice of fuse, example #5.
 — Pre-arcing I^2t
 Maximum I^2t design rule
 X I^2t for sample switch-on pulse

The Joule integral for the second triangle is $[(5.33A)^2 \times 269 \times 10^{-6} \text{sec}] / 3 = 2.55 \times 10^{-3} \text{ A}^2\text{sec}$, and 0.75A fuse is suitable for this case also, see Figure 5b.

However, for the whole pulse, the Joule integral is $4.7 \times 10^{-3} \text{ A}^2\text{sec}$, and the total duration is 563 μsec . For the 0.75A fuse, the Joule integral is only $8.6 \times 10^{-3} \text{ A}^2\text{sec}$ for this pulse duration, so the 1A fuse should be chosen for this application, see Figure 5b.

6. Switch-on pulse and steady-state current

In Figure 6a, the switch-on pulse is a triangle pulse with a $5.1 \times 10^{-3} \text{ A}^2\text{sec}$ Joule integral of 5 msec duration; the 0.75A fuse will meet this requirement, see Figure 6b.

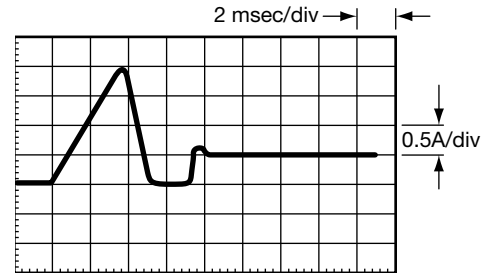

Fig. 6a. Switch-on pulse and steady-state current, example #6.

FUSE PRE-ARCING JOULE INTEGRALS vs. PRE-ARCING TIME

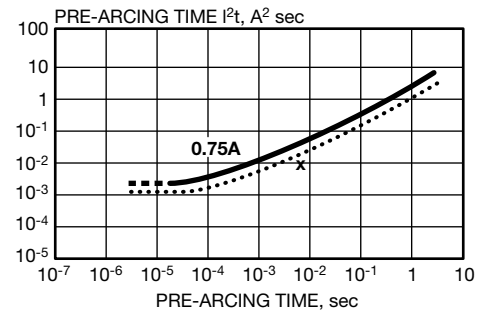

Fig. 6b. Choice of 0.75A fuse, example #6.
 — Pre-arcing I^2t
 Maximum I^2t design rule
 X I^2t for sample switch-on pulse

The steady-state current is 0.5A, and 1A fuse is typically recommended to meet the steady-state condition. Based on steady-state current, the 1A fuse should be chosen for this application.

单击下面可查看定价，库存，交付和生命周期等信息

[>>AVX](#)