

# BestCap<sup>®</sup> Ultra-low ESR High Power Pulse Supercapacitors

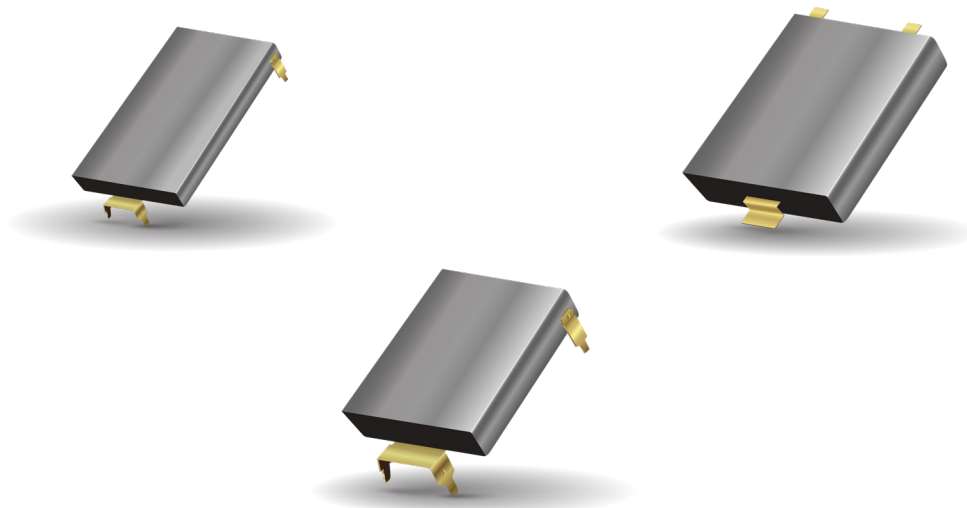

## IMPORTANT INFORMATION/DISCLAIMER

All product specifications, statements, information and data (collectively, the “Information”) in this datasheet or made available on the website are subject to change. The customer is responsible for checking and verifying the extent to which the Information contained in this publication is applicable to an order at the time the order is placed. All Information given herein is believed to be accurate and reliable, but it is presented without guarantee, warranty, or responsibility of any kind, expressed or implied.

Statements of suitability for certain applications are based on AVX’s knowledge of typical operating conditions for such applications, but are not intended to constitute and AVX specifically disclaims any warranty concerning suitability for a specific customer application or use.

**ANY USE OF PRODUCT OUTSIDE OF SPECIFICATIONS OR ANY STORAGE OR INSTALLATION INCONSISTENT WITH PRODUCT GUIDANCE VOIDS ANY WARRANTY.**

The Information is intended for use only by customers who have the requisite experience and capability to determine the correct products for their application. Any technical advice inferred from this Information or otherwise provided by AVX with reference to the use of AVX’s products is given without regard, and AVX assumes no obligation or liability for the advice given or results obtained.

Although AVX designs and manufactures its products to the most stringent quality and safety standards, given the current state of the art, isolated component failures may still occur. Accordingly, customer applications which require a high degree of reliability or safety should employ suitable designs or other safeguards (such as installation of protective circuitry or redundancies) in order to ensure that the failure of an electrical component does not result in a risk of personal injury or property damage.

Unless specifically agreed to in writing, AVX has not tested or certified its products, services or deliverables for use in high risk applications including medical life support, medical device, direct physical patient contact, water treatment, nuclear facilities, weapon systems, mass and air transportation control, flammable environments, or any other potentially life critical uses. Customer understands and agrees that AVX makes no assurances that the products, services or deliverables are suitable for any high-risk uses. Under no circumstances does AVX warrant or guarantee suitability for any customer design or manufacturing process.

Although all product–related warnings, cautions and notes must be observed, the customer should not assume that all safety measures are indicated or that other measures may not be required.

# BestCap® Ultra-low ESR High Power Pulse Supercapacitors



## Table of Contents

INTRODUCTION TO BESTCAP® .....	1
BESTCAP® GENERAL INFORMATION .....	2
<b>SECTION 1</b>	
Electrical Ratings (A-B Series) .....	4
Electrical Ratings (BZ01/02/05/09) .....	5
<b>SECTION 2</b>	
Mechanical Specifications (A-Lead) .....	8
Mechanical Specifications (W-Lead) .....	9
Mechanical Specifications (H-Lead) .....	10
Mechanical Specifications (L-Lead) .....	11
Mechanical Specifications (N-Lead) .....	12
Mechanical Specifications (S-Lead) .....	13
Packaging Specifications/Quantities (BZ01/02/05/09) .....	14
Cleaning/Handling/Storage Conditions/Part Marking/Termination Finish .....	15
Product Safety Materials Handling/Materials and Weight/Typical Weight Data .....	16
<b>SECTION 3</b>	
Electrical Characteristics – Schematic, Typical Characteristics .....	18
Mounting Procedure on a PCB for BestCap® .....	19
Qualification Test Summary .....	20
<b>SECTION 4</b>	
Application Notes/BestCap® Construction/Voltage Drop .....	22
Enhancing the Power Capability of Primary Batteries .....	24
BestCap® for GSM/GPRS PCMCIA Modems .....	25
<b>SECTION 5</b>	
Extended Temperature Range .....	27



# BestCap® Ultra-low ESR High Power Pulse Supercapacitors

## Introduction to BestCap®

### INTRODUCING BESTCAP®: A NEW GENERATION OF PULSE SUPERCAPACITORS

Supercapacitors (also referred to as Electrochemical Capacitors or Double Layer Capacitors) have rapidly become recognized, not only as an excellent compromise between “electronic” or “dielectric” capacitors such as ceramic, tantalum, film and aluminum electrolytic, and batteries (Figure 1), but also as a valuable technology for providing a unique combination of characteristics, particularly very high energy, power and capacitance densities.

There are, however, two limitations associated with conventional supercapacitors, namely: high ESR in the tens of Ohms range, and high capacitance loss when required to supply very short duration current pulses. BestCap® successfully addresses both of these limitations.

The capacitance loss in the millisecond region is caused by the charge transfer (i.e. establishment of capacitance) being carried out primarily by relatively slow moving ions in double layer capacitors.

**Figure 1. Specific Energy of Capacitor Types**

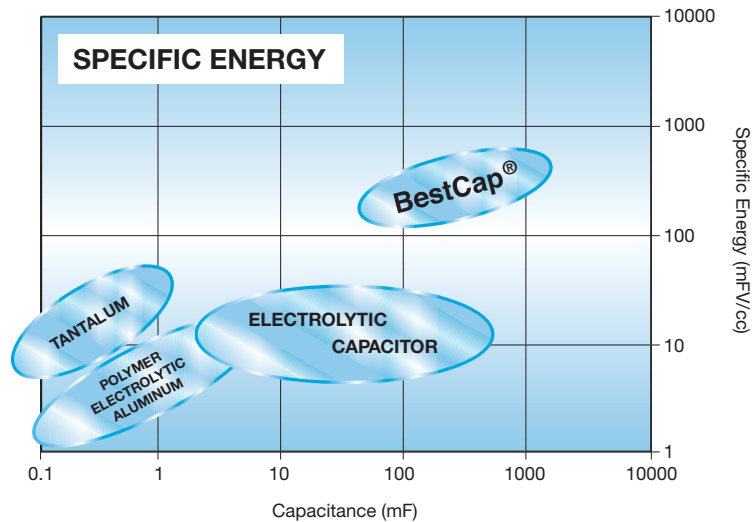

In the above-mentioned “electronic” capacitors, the charge transfer is performed by fast electrons, thereby creating virtually instant rated capacitance value. In the BestCap®, a unique proton polymer membrane is used – charge transfer by protons is close to the transfer rate for electrons and orders of magnitude greater than organic molecules. Figure 2 below illustrates the severe capacitance loss experienced by several varieties of supercapacitors under short pulse width conditions. It can also be seen from Figure 2 how well BestCap® retains its capacitance with reducing

pulse widths.

For comparison purposes, the characteristic of an equivalent capacitance value aluminum electrolytic capacitor is shown in Figure 2. The electrolytic capacitor is many times the volume of the BestCap®.

**Figure 2. Actual Capacitance vs. Pulse Width**

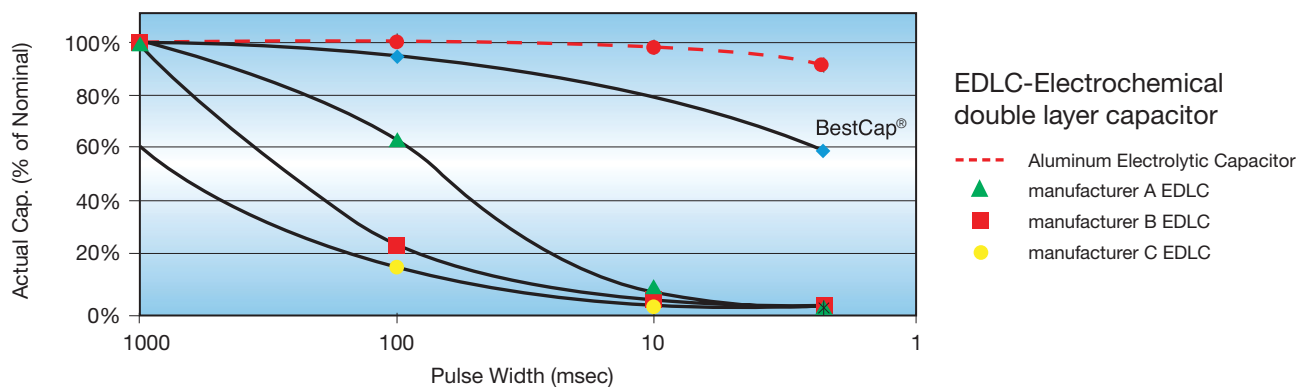

# BestCap® Ultra-low ESR High Power Pulse Supercapacitors



## BestCap® General Information

### BESTCAP® – A SERIES – MAXIMUM CAPACITANCE, LOW ESR B SERIES – LOW PROFILE, LOW ESR

The BestCap® is a low profile device available in four case sizes. Capacitance range is from 6.8mF to 1000mF and includes 7 voltage ratings from 3.6V to 16V.

### BESTCAP® – AVAILABLE LEAD CONFIGURATIONS

#### STANDARD:



Case Size	BODY DIMENSIONS		
	L ±0.5 (0.020) mm (inches)	W ±0.2 (0.008) mm (inches)	H nom mm (inches)
BZ01	28 (1.102)	17 (0.669)	2.3 (0.091) – 6.5 (0.256)
BZ02	48 (1.890)	30 (1.181)	2.9 (0.114) – 6.8 (0.268)
BZ05	20 (0.787)	15 (0.590)	2.3 (0.091) – 6.5 (0.256)
BZ09	17 (0.669)	15 (0.590)	2.3 (0.091)



### ELECTRICAL SPECIFICATIONS

Full dimensional specifications shown in section (2)

Capacitance range:	6.8mF – 1000mF							
Capacitance tolerance:	+80% / -20%							
Voltage ratings (max):	3.6V	4.5V	5.5V	9V	12V	15V	16V	20V
Test voltages:	3.5V	4.2V	5.0V	8.4V	10.0V	11.0V	13.0V	16.0V
Surge test voltage:	4.5V	5.6V	6.9V	11.3V	15.0V	18.8V	20.0V	25.0V
Temperature range:	-20°C to 70°C, consult factory for -40°C and +75°C options							

### HOW TO ORDER

(See Detailed Electrical Specifications for valid combinations)

<b>BZ</b>	<b>0</b>	<b>1</b>	<b>5</b>	<b>A</b>	<b>503</b>	<b>Z</b>	<b>A</b>	<b>B</b>	<b>XX</b>
BestCap®	Standard	Case Size	Rated Voltage	Series	Capacitance Code (Farad Code)	Capacitance Tolerance	Lead Format	Packaging	Not Used For Standard Product (Consult Factory For Special Requirements)
	0 = Standard 1 = High Cap	1 = 28mmx17mm 2 = 48mmx30mm 5 = 20mmx15mm 9 = 17mmx15mm	3 = 3.6V 4 = 4.5V 5 = 5.5V 9 = 9.0V C = 12.0V F = 15.0V G = 16.0V K = 20.0V	A = Maximum Capacitance B = Low Profile		Z = (+80/-20)% 8 = (+50/-20)% P = (+100/-0)% N = (+30/-30)%	A, H, L, N, S or W	B = Bulk	



# SECTION 1

## Electrical Ratings

# BestCap® Ultra-low ESR High Power Pulse Supercapacitors

## Electrical Ratings (A-B Series)



### SECTION 1: ELECTRICAL RATINGS CAPACITANCE / VOLTAGE / CASE SIZE MATRIX

A-SERIES – MAXIMUM CAPACITANCE											
Capacitance		Rated Voltage DC at 25°C									
mF	Code	3.6V		5.5V		9.0V		12.0V		16.0V	
		Case Size	Lead Styles	Case Size	Lead Styles	Case Size	Lead Styles	Case Size	Lead Styles	Case Size	Lead Styles
10	103								BZ05	N, S	
22	223								BZ01	A, H, S	
33	333			BZ05	N, S, W	BZ01	A, H, S				
47	473								BZ11	S	
50	503			BZ01	A, H, S, L						
68	683			BZ05	S						
70	703	BZ01	A, H, S, L								
90	903								BZ02	A, H, L	
100	104			BZ01	A, H, S, L						
120	124					BZ02	A, H, L				BZ12 A, L
140	144	BZ01	A, H, S, L								
150	154			BZ15	S						
200	204			BZ02	A, H, L						
280	284	BZ02	A, H, L								
400	404			BZ02	A, H, L						
470	474			BZ12	A						
560	564	BZ02	A, H, L								
1000	105			BZ12	A, H, L						

B-SERIES – LOW PROFILE															
Capacitance		Rated Voltage DC at 25°C													
mF	Code	3.6V		4.5V		5.5V		9.0V		12.0V		15.0V		20.0V	
		Case Size	Lead Styles	Case Size	Lead Styles	Case Size	Lead Styles	Case Size	Lead Styles	Case Size	Lead Styles	Case Size	Lead Styles	Case Size	Lead Styles
4.7	472														BZ05 N, S, W
6.8	682													BZ05 N, S, W	BZ01 N, S, W
15	153			BZ09	N, S, W	BZ05	N, S, W			BZ01	A, H, S				
22	223			BZ05	N, S, W			BZ01	A, H, S						
30	303					BZ01	S, N								
33	333			BZ01	S, N, W	BZ05	S, N, W								
47	473			BZ15	N, S, W	BZ11	S								
50	503	BZ01	S, N, W												
60	603					BZ01	A, H, S, L								
100	104	BZ11	S, N, W												

# BestCap® Ultra-low ESR High Power Pulse Supercapacitors

Electrical Ratings (BZ01/02/05/09)



## SECTION 1: ELECTRICAL RATINGS

### ELECTRICAL RATINGS - SEE SECTION 2 FOR DIMENSIONAL REFERENCES

BZ 01 CASE SIZE									
Part Number	Rated Voltage (Volts)	Capacitance (mF) Nominal +80%, -20%	ESR (mOhms at 1 kHz)		Leakage Current (µA max) Maximum	Height A-Lead (mm) H max	Height H-Lead (mm) H max	Height S-Lead (mm) H max	Height S-Lead (AJ)*(mm) H max
			T typical	Maximum					
<b>3.6V</b>									
BZ013B503Z_B	3.6V	50	100	120	5	NA	NA	3.2	2.1
BZ013A703Z_B		70	140	168	5	3.5	6.4	4.0	2.9
BZ113B104Z_B		100	100	120	10	NA	NA	3.2	2.1
BZ013A144Z_B		140	70	84	5	5.3	8.2	5.8	NA
<b>4.5V</b>									
BZ014B333Z_B	4.5V	33	150	180	5	NA	NA	3.5	2.4
<b>5.5V</b>									
BZ015B303Z_B	5.5V	30	160	192	5	NA	NA	3.8	2.7
BZ015A503Z_B		50	160	192	5	4.1	7.0	4.6	3.5
BZ015B603Z_B		60	80	96	10	5.4	8.3	5.9	NA
BZ015A104Z_B		100	80	96	10	6.7	9.6	7.2	NA
<b>9.0V</b>									
BZ019B223Z_B	9.0V	22	250	300	5	4.7	7.6	5.2	4.1
BZ019A333Z_B		33	250	300	5	5.5	8.4	6.0	4.9
<b>12.0V</b>									
BZ01CB153Z_B	12.0V	15	350	420	5	5.9	8.8	6.4	5.3
BZ01CA223Z_B		22	350	420	5	7.1	10.0	7.6	6.5
<b>16.0V</b>									
BZ01GB682ZSB	16.0V	6.8	400	480	10			6.8	
<b>20.0V</b>									
BZ01KB682ZSB	20.0V	6.8	400	480	10			6.8	

\* Select S-Lead BZ01 BestCap® are available with insulation on the bottom of the part and zero clearance from the PCB. See section 2.6 for dimensions. To order, please add special requirement AJ to the end of the part number. Example: BZ013B503ZSBAJ

BZ 02 CASE SIZE								
Part Number	Rated Voltage (Volts)	Capacitance (mF) Nominal +80%, -20%	ESR (mOhms at 1 kHz)		Leakage Current (µA max) Maximum	Height A-Lead (mm) H max	Height H-Lead (mm) H max	Height L-Lead (mm) H max
			Typical	Maximum				
<b>3.6V</b>								
BZ023A284Z_B	3.6V	280	45	54	20	3.5	6.4	3.7
BZ023A564Z_B		560	25	30	40	5.3	8.2	5.5
<b>5.5V</b>								
BZ025A204Z_B	5.5V	200	60	72	20	4.1	7.0	4.3
BZ025A404Z_B		400	35	42	40	6.7	9.6	6.9
BZ125A105Z_B		1000	35	42	120	6.7	9.6	6.9
<b>9.0V</b>								
BZ029A124Z_B	9.0V	120	70	84	20	5.8	8.7	6.0
<b>12.0V</b>								
BZ02CA903Z_B	12.0V	90	90	108	20	7.4	10.3	7.6
<b>16.0V</b>								
BZ12GA124Z_B	16.0V	120	160	192	60	9.1		9.1

All capacitance, ESR, and leakage current values listed in these tables are at room temperature only.



# BestCap® Ultra-low ESR High Power Pulse Supercapacitors

## Electrical Ratings (BZ01/02/05/09)



BZ 05 CASE SIZE							
Part Number	Rated Voltage (Volts)	Capacitance (mF) Nominal +80%, -20%	ESR (mOhms at 1 kHz)		Leakage Current (µA max) Maximum	Height N-Lead (mm)	Height S-Lead (mm)
			Typical	Maximum		H max	H max
<b>4.5V</b>							
BZ054B223Z_B	4.5V	22	170	204	5	2.3	2.3
BZ154B473Z_B		47	170	204	10	2.3	2.3
<b>5.5V</b>							
BZ055B153Z_B	5.5V	15	250	300	5	2.7	2.7
BZ055A333Z_B		33	250	300	5	3.5	3.5
BZ055B333Z_B		33	125	150	10	NA	4.8
BZ155A104Z_B		100	125	150	20	NA	6.1
<b>12.0V</b>							
BZ05CA103Z_B	12.0V	10	500	600	55	6.5	6.5
<b>15.0V</b>							
BZ05FB682Z_B	15.0V	6.8	500	600	10	5.8	5.8
<b>20.0V</b>							
BZ05KB472ZSB	20.0V	4.7	700	840	10		6.7

BZ 09 CASE SIZE							
Part Number	Rated Voltage (Volts)	Capacitance (mF) Nominal +80%, -20%	ESR (mOhms at 1 kHz)		Leakage Current (µA max) Maximum	Height N-Lead (mm)	Height S-Lead (mm)
			Typical	Maximum		H max	H max
<b>4.5V</b>							
BZ094B153Z_BAI	4.5V	15	250	300	5	2.4*	2.3*

\* The 4.5V BZ09 BestCap® are available only in a special low profile version.

All capacitance, ESR, and leakage current values listed in these tables are at room temperature only.



# SECTION 2

## Mechanical Specifications

# BestCap® Ultra-low ESR High Power Pulse Supercapacitors

## Mechanical Specifications (A-Lead)



### SECTION 2: MECHANICAL SPECIFICATIONS

#### 2.1 CASE DIMENSIONS & RECOMMENDED PCB LAYOUT

##### 2.1.1: A-STYLE CONFIGURATION (PIN THROUGH HOLE)

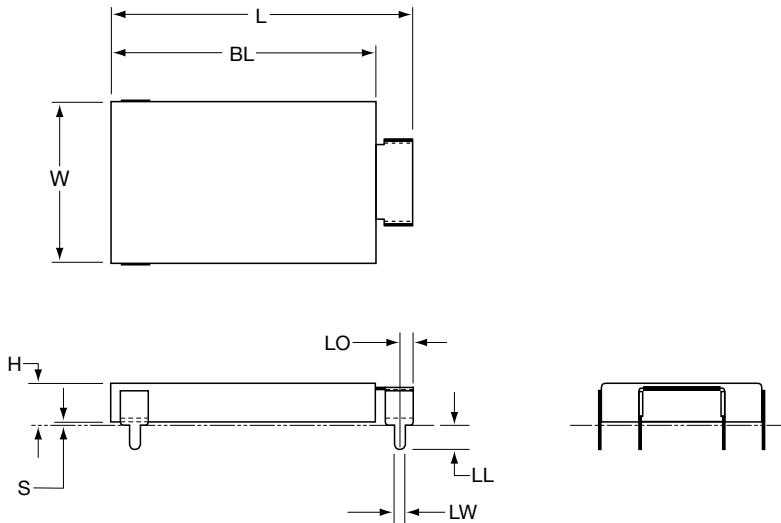

**TABLE 2.1.1: A-STYLE DIMENSIONS**

Case Size	Case Dimensions: mm (inches)							
	BL +1.0 (0.040)/-0	W +1.0 (0.040)/-0	H (Maximum)	L ±1.0 (0.040)	S ±0.1 (0.004)	LO ±0.2 (0.008)	LW ±0.2 (0.008)	LL ±0.2 (0.008)
BZ01	28 (1.102)	17 (0.669)	See Section 1	32	0.45 (0.018)	1.5 (0.059)	1.27 (0.050)	2.5 (0.098)
BZ02	48 (1.890)	30 (1.181)	See Section 1	52	0.45 (0.018)	1.5 (0.059)	1.27 (0.050)	2.5 (0.098)

##### 2.1.2: A-LEAD CONFIGURATION (THROUGH HOLE)

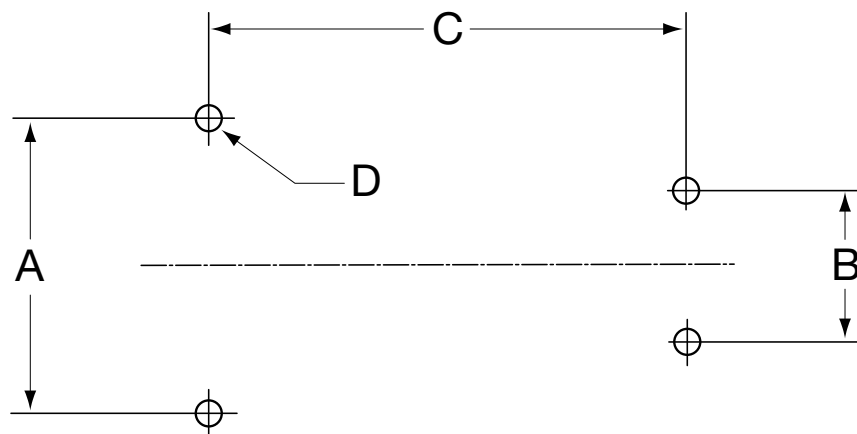

**TABLE 2.1.2: A-LEAD LAYOUT DIMENSIONS**

Case Size	Recommended PCB Dimensions: mm (inches)			
	A ±0.05 (0.002)	B ±0.05 (0.002)	C ±0.05 (0.002)	D ±0.1 (0.004)
BZ01	17.25 (0.679)	8.90 (0.350)	28 (1.102)	Ø1.4 (0.055)
BZ02	30.25 (1.191)	8.90 (0.350)	48 (1.890)	Ø1.4 (0.055)

# BestCap® Ultra-low ESR High Power Pulse Supercapacitors

## Mechanical Specifications (W-Lead)

### SECTION 2: MECHANICAL SPECIFICATIONS (CONT'D)

#### 2.2.1: W-STYLE CASE DIMENSIONS

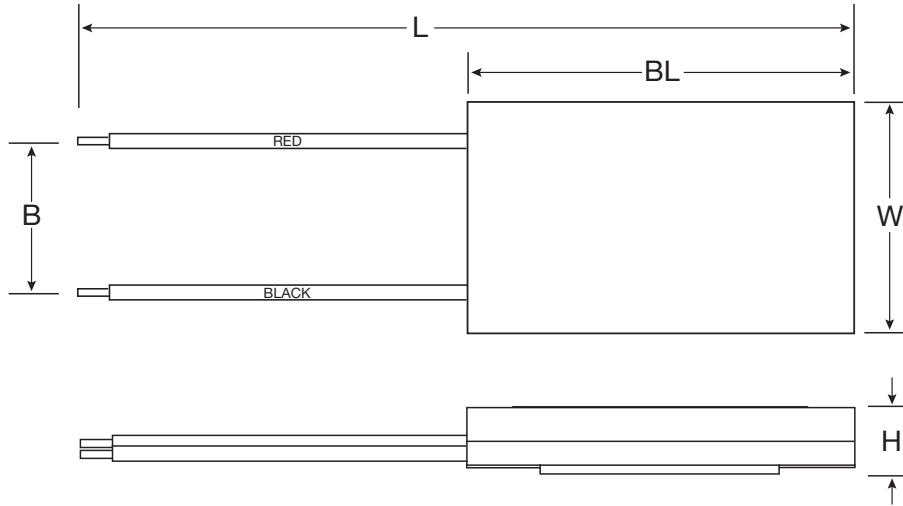

**TABLE 2.2.1: W-STYLE CASE DIMENSIONS**

Case Size	Case Dimensions: mm (inches)				
	L ±0.5 (0.020)	W +1.0 (0.040)/-0	H (Maximum)	BL +1.0 (0.040)/-0	B ±0.5 (0.020)
BZ05	50.5 (1.988)	15 (0.591)	See Section 1	25.4 (1.0)	10 (0.394)

# BestCap® Ultra-low ESR High Power Pulse Supercapacitors

## Mechanical Specifications (H-Lead)



### SECTION 2: MECHANICAL SPECIFICATIONS (CONT'D)

#### 2.3.1: H-STYLE CASE DIMENSIONS (THROUGH HOLE EXTENDED HEIGHT)

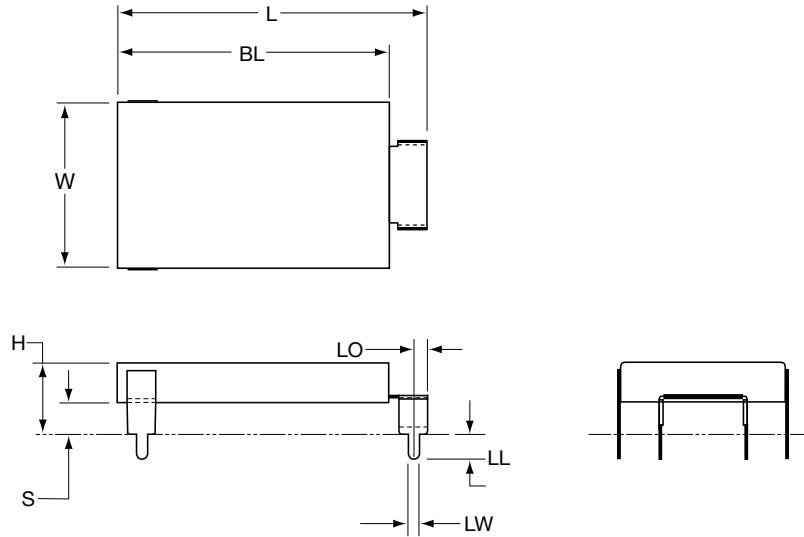

**TABLE 2.3.1: H-STYLE CASE DIMENSIONS**

Case Size	Case Dimensions: mm (inches)							
	BL +1.0 (0.040)/-0	W +1.0 (0.040)/-0	H (Maximum)	L ±1.0 (0.040)	S +0.5 (0.020)/ -0.4 (0.016)	LO ±0.2 (0.008)	LW ±0.2 (0.008)	LL ±0.2 (0.008)
BZ01	28 (1.102)	17 (0.669)	See Section 1	32 (1.260)	3.0 (0.118)	1.5 (0.059)	1.27 (0.050)	2.5 (0.098)
BZ02	48 (1.890)	30 (1.181)	See Section 1	52 (2.047)	3.0 (0.118)	1.5 (0.059)	1.27 (0.050)	2.5 (0.098)
BZ05	20 (0.787)	15.6 (0.614)	See Section 1	24.3 (0.957)	3.0 (0.118)	1.5 (0.059)	1.27 (0.050)	2.5 (0.098)

#### 2.3.2: H-LEAD CONFIGURATION (THROUGH HOLE EXTENDED HEIGHT)

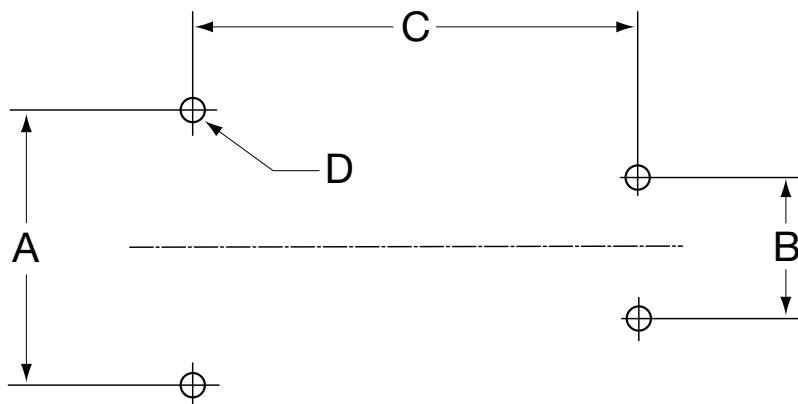

**TABLE 2.3.2: H-LEAD LAYOUT DIMENSIONS**

Case Size	PCB Dimensions: mm (inches)			
	A ±0.05 (0.002)	B ±0.05 (0.002)	C ±0.05 (0.002)	D ±0.1 (0.004)
BZ01	17.25 (0.679)	8.90 (0.350)	28 (1.102)	Ø1.4 (0.055)
BZ02	30.25 (1.191)	8.90 (0.350)	48 (1.890)	Ø1.4 (0.055)
BZ05	15.25 (0.600)	8.90 (0.350)	19 (0.748)	Ø1.4 (0.055)

# BestCap® Ultra-low ESR High Power Pulse Supercapacitors

## Mechanical Specifications (L-Lead)

### SECTION 2: MECHANICAL SPECIFICATIONS (CONT'D)

#### 2.4.1: L-LEAD CONFIGURATION (PLANAR MOUNT)

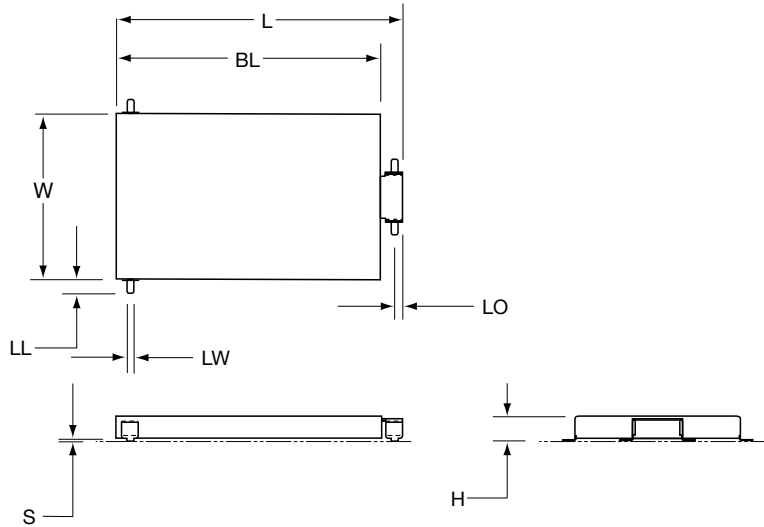

**TABLE 2.4.1: L-STYLE CASE DIMENSIONS**

Case Size	Case Dimensions: mm (inches)							
	BL +1.0 (0.040)/-0	W +1.0 (0.040)/-0	H (Maximum)	L ±1.0 (0.040)	S ±0.2 (0.008)	LO ±0.2 (0.008)	LW ±0.2 (0.008)	LL ±0.5 (0.020)
BZ01	28 (1.102)	17 (0.6691)	See Section 1	33	0.55 (0.022)	1.5 (0.059)	1.27 (0.050)	2.4 (0.098)
BZ02	48 (1.890)	30 (1.181)	See Section 1	52	0.55 (0.022)	1.5 (0.059)	1.27 (0.050)	2.4 (0.098)

#### 2.4.2: L-LEAD CONFIGURATION (PLANAR MOUNT)

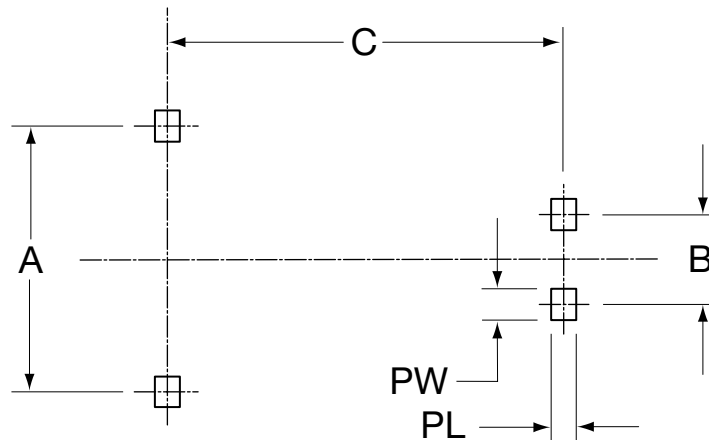

**TABLE 2.4.2: L-STYLE LEAD LAYOUT**

Case Size	PCB Dimensions: mm (inches)				
	A ±0.1 (0.004)	B ±0.1 (0.004)	C ±0.1 (0.004)	PL ±0.2 (0.008)	PW ±0.2 (0.008)
BZ01	19.2 (0.776)	10.8 (0.425)	28 (1.102)	3.0 (0.118)	3.7 (0.146)
BZ02	32.2 (1.268)	10.8 (0.425)	48 (1.890)	3.2 (0.126)	3.7 (0.146)

# BestCap® Ultra-low ESR High Power Pulse Supercapacitors

## Mechanical Specifications (N-Lead)



### SECTION 2: MECHANICAL SPECIFICATIONS (CONT'D)

#### 2.5.1: N-LEAD CONFIGURATION

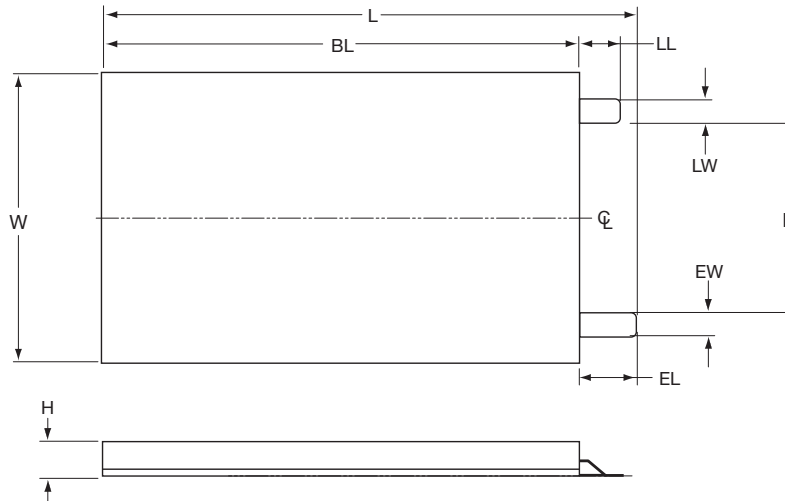

TABLE 2.5.1: N-STYLE CASE DIMENSIONS

Case Size	Case Dimensions: mm (inches)							
	L ±0.5 (0.020)	W +1.0 (0.040)/-0	H (Maximum)	B ±0.5 (0.020)	LL ±0.2 (0.008)	LW ±0.2 (0.008)	EL ±0.5 (0.020)	EW ±0.5 (0.020)
BZ01	30.5 (1.201)	17 (0.669)	See Section 1	11.2 (0.441)	2.5 (0.098)	1.4 (0.055)	2.5 (0.098)	1.4 (0.055)
BZ05	23.5 (0.925)	15 (0.591)	See Section 1	7.5 (0.295)	2.5 (0.098)	2.5 (0.098)	3.5 (0.138)	2.5 (0.098)
BZ09	20.5 (0.807)	15 (0.591)	See Section 1	7.5 (0.295)	2.5 (0.098)	2.5 (0.098)	3.5 (0.138)	2.5 (0.098)

#### 2.5.2: N-LEAD CONFIGURATION (PLANAR MOUNT)

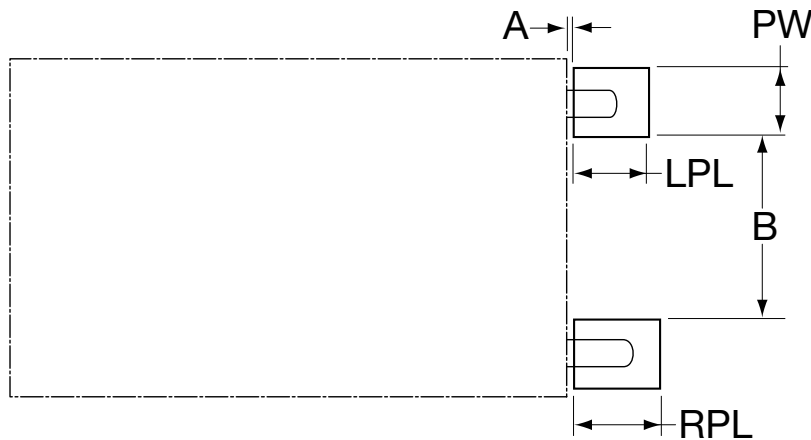

TABLE 2.5.2: N-STYLE LEAD LAYOUT

Case Size	PCB Dimensions: mm (inches)				
	A ±0.5 (0.020)	B ±0.1 (0.004)	PW ±0.1 (0.004)	LPL ±0.1 (0.004)	RPL ±0.1 (0.004)
BZ01	0.5 (0.020)	9.5 (0.374)	3.2 (0.126)	3.5 (0.138)	3.5 (0.138)
BZ05	1.0 (0.039)	5.9 (0.232)	4.1 (0.161)	2.5 (0.098)	3.5 (0.138)
BZ09	1.0 (0.039)	5.9 (0.232)	4.1 (0.161)	2.5 (0.098)	3.5 (0.138)

# BestCap® Ultra-low ESR High Power Pulse Supercapacitors

## Mechanical Specifications (S-Lead)



### SECTION 2: MECHANICAL SPECIFICATIONS (CONT'D) 2.6.1: S-LEAD CONFIGURATION (PLANAR MOUNT)

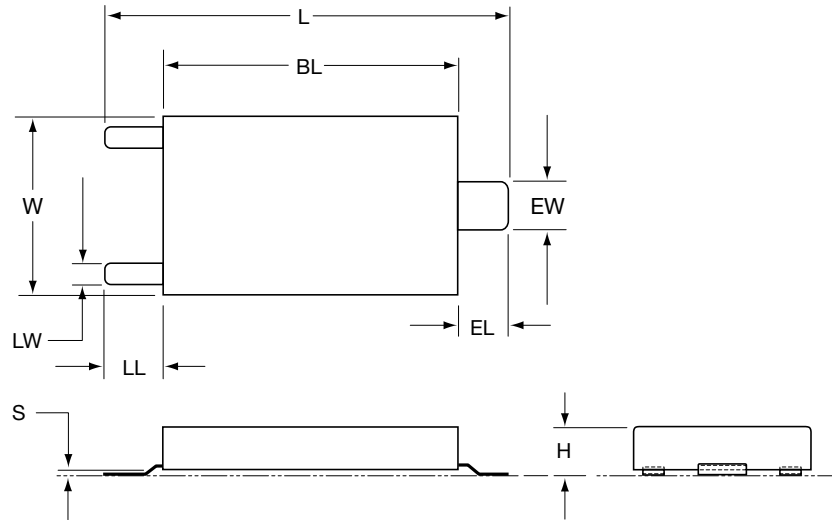

**TABLE 2.6.1: S-STYLE CASE DIMENSIONS**

Case Dimensions: mm (inches)								
Case Size	BL +1.0 (0.040)/-0	W +1.0 (0.040)/-0	H (Maximum)	L ±1.0 (0.040)	EL ±0.5 (0.020)	EW ±0.2 (0.008)	LL ±0.5 (0.020)	LW ±0.2 (0.008)
BZ01	28 (1.102)	17 (0.669)	See Section 1	38.7 (1.524)	5.0 (0.197)	4.5 (0.177)	5.7 (0.224)	2.0 (0.079)
BZ05	20 (0.787)	15 (0.591)	See Section 1	26 (1.024)	3.5 (0.138)	2.5 (0.098)	2.5 (0.098)	2.5 (0.098)
BZ09	17 (0.669)	15 (0.591)	See Section 1	23 (0.906)	3.5 (0.138)	2.5 (0.098)	2.5 (0.098)	2.5 (0.098)

### 2.6.2: S-LEAD LAYOUT (PLANAR MOUNT)

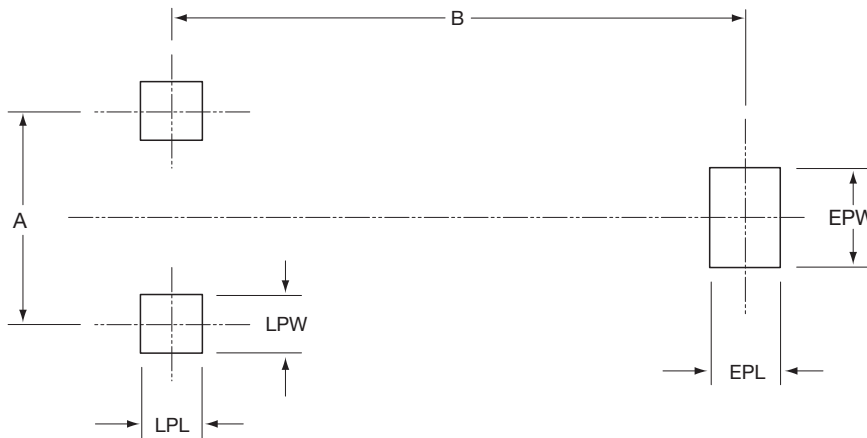

**Planar Mount  
"S"**

Available in  
BZ01, BZ05  
& BZ09  
Case Size Only

**TABLE 2.6.2: S-STYLE PAD LAYOUT DIMENSIONS**

PCB Dimensions: mm (inches)						
Case Size	A ±0.1 (0.004)	B ±0.1 (0.004)	EPL ±0.1 (0.004)	EPW ±0.1 (0.004)	LPL ±0.1 (0.004)	LPW ±0.1 (0.004)
BZ01	13.0 (0.512)	35.1 (1.382)	4.5 (0.177)	6.0 (0.236)	5.8 (0.228)	3.5 (0.138)
BZ05	10.0 (0.394)	25.0 (0.984)	3.0 (0.118)	4.5 (0.177)	2.9 (0.114)	4.5 (0.177)
BZ09	10.0 (0.394)	22.0 (0.886)	3.0 (0.118)	4.5 (0.177)	2.9 (0.114)	4.5 (0.177)



# BestCap® Ultra-low ESR High Power Pulse Supercapacitors

## Packaging Specifications/Quantities (BZ01/02/05/09)



### SECTION 2: MECHANICAL SPECIFICATIONS (CONT'D)

#### 2.7: PACKAGING SPECIFICATIONS

##### BZ01 CASE:

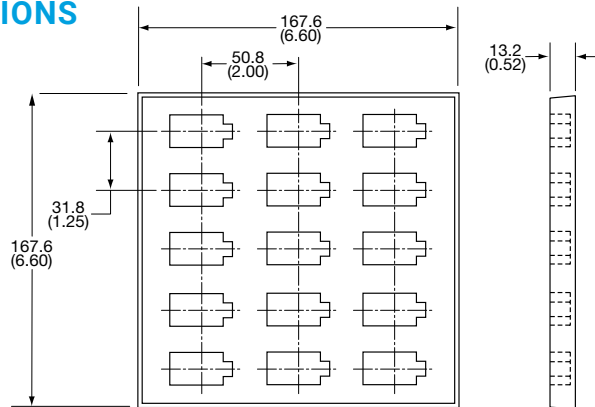

##### BZ02 CASE:

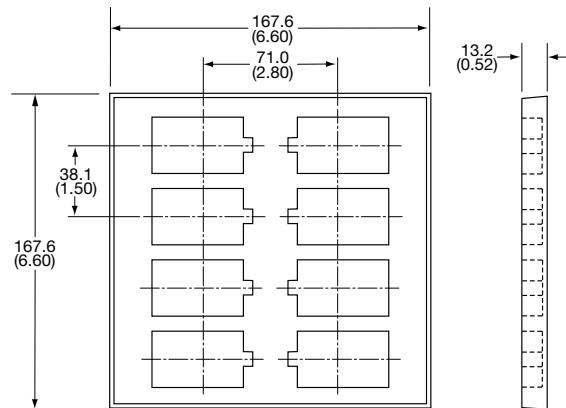

##### BZ05, BZ09 CASE:

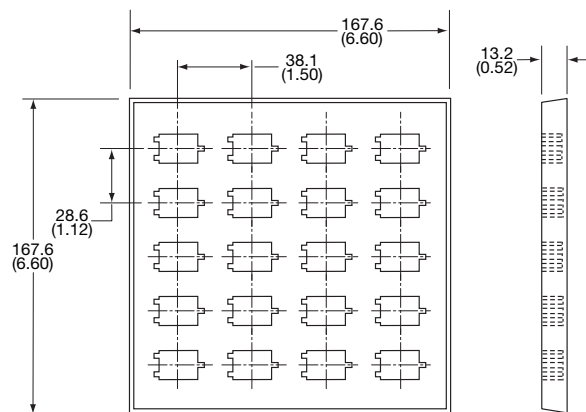

This specification applies when our electrochemical supercapacitors are packed using a 165mm by 165mm container. The parts are held in place by a 166mm by 166mm lid.

#### PACKAGING QUANTITIES:

Size	No. of Rows	No. of Columns	Pieces/Tray
BZ01	5	3	15
BZ02	4	2	8
BZ05	5	4	20
BZ09	5	4	20

# BestCap® Ultra-low ESR High Power Pulse Supercapacitors



## Cleaning/Handling/Storage Conditions/Part Marking/Termination Finish

### SECTION 2: MECHANICAL SPECIFICATIONS

#### 2.8 CLEANING

The BestCap® supercapacitor is cleaned prior to shipment. Should cleaning be required prior to insertion into the application, it is recommended to use a small amount of propanol taking care not to remove the label. The cell should not be immersed due to possible deterioration of the epoxy encapsulation. Care must also be taken not to bend the leads.

#### 2.9 HANDLING

Care should be taken not to allow grease or oil into the part as it may lead to soldering problems. Handling should be minimized to reduce possible bending of the electrodes leads.

#### 2.10 STORAGE CONDITIONS

AVX BestCap® supercapacitor is unaffected by the following storage conditions:

- Temperature: 15°C ~ 35°C
- Humidity: 45% RH ~ 75% RH

This temperature and humidity range is specified for consideration of terminal solderability. BestCap® are able to withstand shelf life at 70°C for 1000 hours.

#### 2.11 PART MARKING

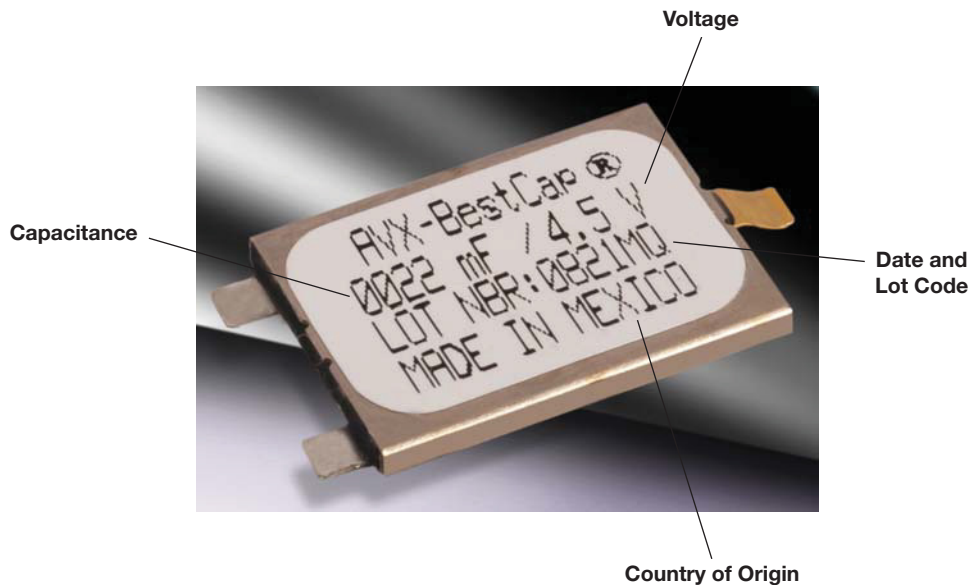

#### 2.12 TERMINATION FINISH

Gold over nickel, tin over nickel.

# BestCap® Ultra-low ESR High Power Pulse Supercapacitors



## Product Safety Materials Handling/Materials and Weight/Typical Weight Data

### 2.13 PRODUCT SAFETY MATERIALS HANDLING

#### Precautions

- Do not disassemble the capacitor.
- Do not incinerate the capacitor and do not use incineration for disposal.
- The capacitor contains polymeric electrolyte and carbon electrodes. However, since the polymer is composed of acid based chemical ingredients, if punctured or dismantled and the skin is contacted with the capacitor internal components, it is recommended to wash the skin with excess of running water.
- If any internal material contacts the eyes, rinse thoroughly with running water.
- Be aware not to apply over-voltage. Combination of charging at voltage greater than the nominal, plus high temperature, plus prolonged time may result in capacitor bulging or rupturing.

### 2.14 BESTCAP® MATERIALS AND WEIGHT

Materials	Constituent	RoHS Compliant?	BZ01	BZ02	BZ05	BZ09
			Weight %	Weight %	Weight %	Weight %
Case	Stainless Steel	YES	56.7%	44.5%	64.8%	64.8%
Leads (A, H, and L lead only)	Stainless Steel	YES	4.2%	0.7%		
Electrode	Stainless Steel	YES	13.6%	8.0%	13.6%	13.6%
Electrode Insulation	Laminating Adhesive	YES	2.3%	1.0%	2.4%	2.4%
Core	Metallized Current Collector	YES	5.2%	8.0%	1.6%	1.6%
	Current Collector	YES	2.5%	14.3%	1.0%	1.0%
	Active Electrode	YES	1.0%	5.7%	0.4%	0.4%
	Core Sealant	YES	0.9%	5.2%	0.3%	0.3%
Encapsulant	Epoxy	YES	10.3%	11.4%	11.8%	11.8%
Bottom Insulation	Laminating Adhesive	YES	2.3%	1.0%	2.4%	2.4%
Label	Label	YES	1.0%	0.2%	1.8%	1.8%
TOTAL			100%	100%	100%	100%

#### BestCap® is RoHS compliant

May be assembled with Pb-Free solder.



### BESTCAP® – TYPICAL WEIGHT DATA

Rated Voltage (V)	Capacitance (mF)	Part Number	Weight (g)
3.6V	50	BZ013B503Z_B	2.9
	70	BZ013A703Z_B	4.2
	100	BZ113B104Z_B	2.9
	140	BZ013A144Z_B	5.3
	280	BZ023A284Z_B	12.2
	560	BZ023A564Z_B	15.9
4.5V	15	BZ094B153Z_B	1.5
	22	BZ054B223Z_B	1.8
	33	BZ014B333Z_B	3.2
	47	BZ154B473Z_BBQ	1.8
5.5V	15	BZ055B153Z_B	1.9
	30	BZ015B303Z_B	3.4
	33	BZ055A333Z_B	2.3
	33	BZ055B333Z_B	2.1
	50	BZ015A503Z_B	4.6
	60	BZ015B603Z_B	5.5
	68	BZ055A683Z_B	3.4
	100	BZ015A104Z_B	6.1
	200	BZ025A204Z_B	13.3
	400	BZ025A404Z_B	18.4
1000	BZ125A105Z_B	18.4	
9.0V	22	BZ019B223Z_B	4.4
	33	BZ019A333Z_B	5.0
	120	BZ029A124Z_B	15.6
12.0V	10	BZ05CA103Z_B	3.5
	15	BZ01CB153Z_B	5.0
	22	BZ01CA223Z_B	6.2
	90	BZ02CA903Z_B	19.3
15.0V	6.8	BZ05FB682Z_B	2.8
16.0V	124	BZ12GA124Z_B	25





# SECTION 3

## Electrical Characteristics

# BestCap® Ultra-low ESR High Power Pulse Supercapacitors



## Electrical Characteristics – Schematic, Typical Characteristics

### SECTION 3: ELECTRICAL CHARACTERISTICS – SCHEMATIC

#### 3.1 Terminal Connections: 3.1.1: S-Lead

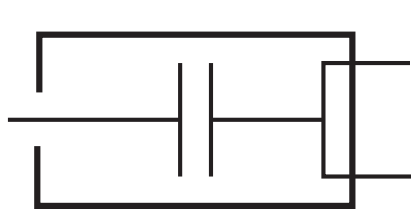

Common terminals connected to case

#### 3.1.2: A-, H- & L-Lead

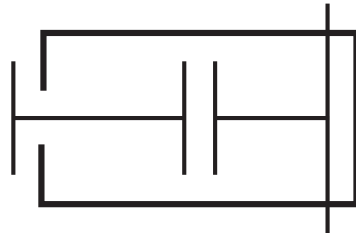

Common terminals connected to case

#### 3.1.3: C- & N-Lead

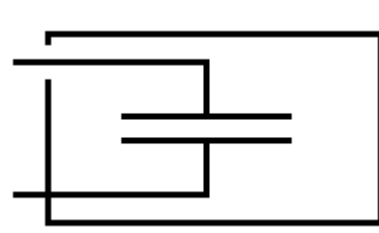

Devices are non polar but it is usual to maintain case at ground potential

### SECTION 3.2: TYPICAL CHARACTERISTICS

Capacitance vs. Temperature

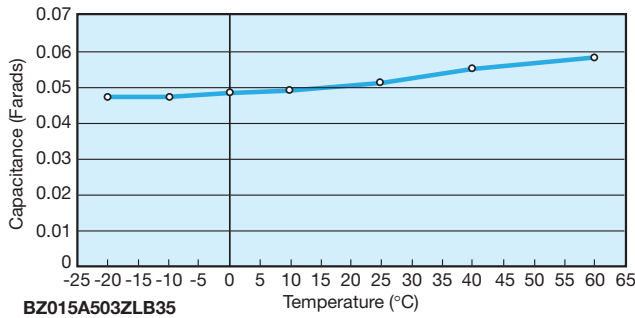

ESR vs. Temperature

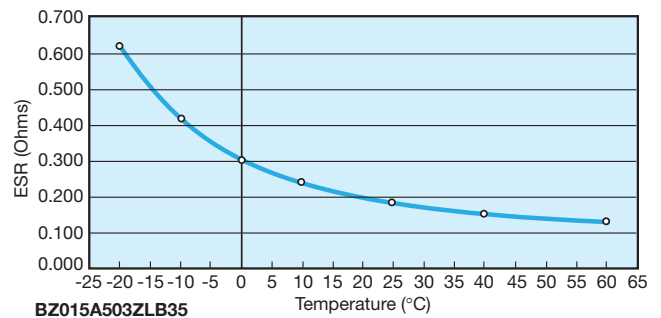

ESR vs. Frequency

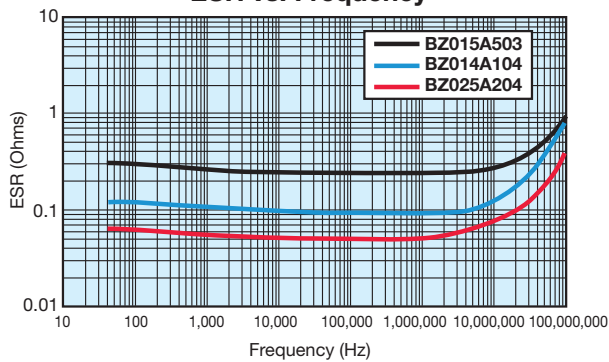

ESR Comparison

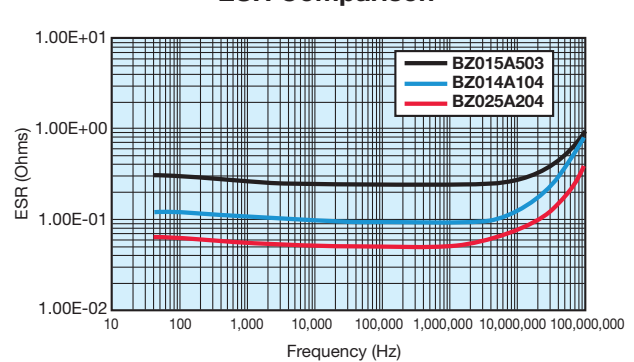

Impedance vs. Frequency

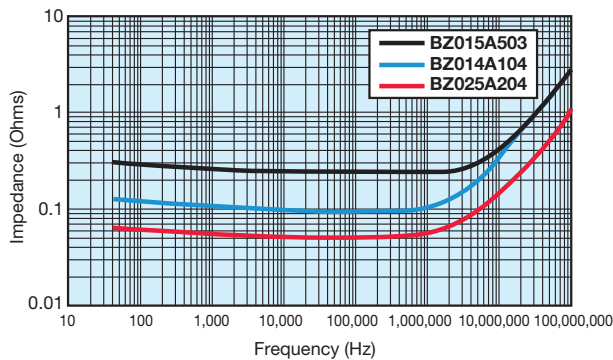

Impedance Comparison

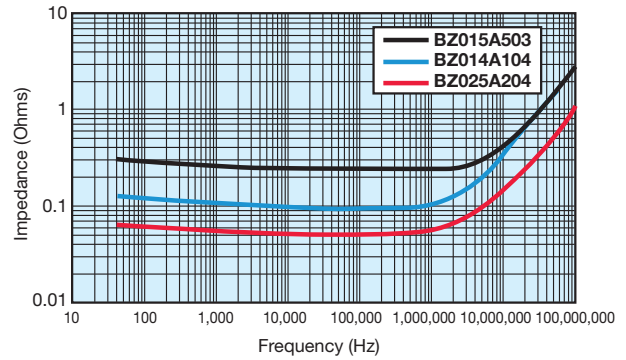

# BestCap® Ultra-low ESR High Power Pulse Supercapacitors

## Mounting Procedure on a PCB for BestCap®



### SECTION 3.3: MOUNTING PROCEDURE ON A PCB FOR BESTCAP®

BestCap® products can be mounted on PCBs by either selectively heating only the capacitor terminals by using a pulsed reflow soldering station or by using hand soldering. IR Reflow or wave soldering may not be used. The main body of the device should be less than 60°C at all times.

#### PULSED REFLOW SOLDERING

Application data for the 'Unitek' pulsed-reflow soldering station.

##### Equipment:

<b>Controller</b>	Uniflow 'Pulsed Thermode Control'
<b>Head</b>	Thin-line Reflow Solder Head
<b>Solder paste type</b>	No Clean Flux
<b>Solder composition</b>	63% Sn, 37% Pb
<b>Percent solids</b>	88%
<b>Solder thickness</b>	6 mils
<b>Solder-weld tip size</b>	0.075"
<b>Solder-weld tip force</b>	6 lbs.

##### Temperature Profile:

	Temperature	Time
<b>Pre-heat</b>	130°C	0 sec.
<b>Rise</b>	440°C (±10)	2 sec.
<b>Reflow</b>	440°C (±10)	2 sec.
<b>Cool</b>	165°C	

#### HAND SOLDERING STATION

<b>Equipment:</b>	Temperature controlled, 50W general purpose iron
<b>Solder type:</b>	63Sn/37Pb, rosin core wire
<b>Temperature:</b>	400°C (+20°C - 100°C)
<b>Time:</b>	2 to 5 seconds maximum, smaller time (2 sec.) at 420°C and 5 sec. at 300°C, overall it being a time-temperature relationship. Shorter time, higher temperature is preferred.
<b>Solder Type:</b>	Lead Free, 95Sn/5Ag
<b>Temperature:</b>	430°C (+20°C - 100°C)
<b>Time:</b>	2 to 5 seconds maximum, smaller time (2 sec.) at 450°C and 5 sec. at 330°C, overall a time-temperature relationship. Shorter time, higher temperature is preferred.

In both cases, the main body of the BestCap® part should be less than 60°C at all times.

# BestCap® Ultra-low ESR High Power Pulse Supercapacitors

## Qualification Test Summary



### SECTION 3.4: QUALIFICATION TEST SUMMARY

Test	Test Method		Parameter	Limits	
<b>Initial Capacitance Measurement</b>	Charge to test voltage at room temperature. Disconnect parts from voltage to remove charging effects. Discharge cells with a constant current (4 mA) noting voltage and time 1 and 2 seconds after beginning discharge. $C = I * dt/dv$		Capacitance (Cap)	+80% / -20% of rated Cap	
<b>Initial DCL Measurement</b>	Charge to test voltage at room temperature. Disconnect parts from voltage to remove charging effects. Note voltage and time 5 minutes and 25 minutes after disconnecting. $I = C * dV/dt$		Leakage Current (DCL)	Within Limit	
<b>Initial ESR Measurement</b>	Measurement frequency @ 1kHz; Measurement voltage @ 10 mV at room temperature		Equivalent Series Resistance (ESR)	+20% / -50% of typical value	
<b>Load Life</b>	Apply test voltage at 70°C for 1000 hours. Allow to cool to room temperature and measure Cap, DCL and ESR		DCL Cap ESR	< 2.0x rated max. > 0.7x rated < 3.0x rated	
<b>Shelf Life</b>	Maintain at 70°C for 1000 hours with no voltage applied. Allow to cool to room temperature and measure Cap, DCL and ESR.		DCL Cap ESR	< 1.5x rated max. > 0.7x rated < 2.0x rated	
<b>Humidity Life</b>	Maintain at 40°C / 95% RH for 1000 hours. Allow to cool to room temperature and measure Cap, DCL and ESR.		DCL Cap ESR	< 1.5x rated max. > 0.7x rated < 1.5x rated	
<b>Leg pull strength</b>	Apply an increasing force in shear mode until leg pulls away		Yield Force (A and L leads only)	Not less than 25 pounds shear	
<b>Surge Voltage</b>	Step				
	1	Apply 125% of the rated voltage for 10 seconds	DCL	< 1.5x rated max.	
	2	Short the cell for 10 minutes	Cap	> 0.7x rated	
	3	Repeat 1 and 2 for 1000 cycles	ESR	< 1.5x rated	
<b>Temperature Cycling</b>	Step				
	1	Ramp oven down to -20°C and then hold for 15 min.	DCL	< 1.5x rated max.	
	2	Ramp oven up to 70°C and then hold for 15 min.	Cap	> 0.7x rated	
	3	Repeat 1 and 2 for 100 cycles	ESR	< 1.5x rated	
<b>Temperature Characteristics</b>	Step	Temp	Soak Time (prior to test)		
	1	-40°C	4 hours	DCL	
		Measure Cap, ESR, DCL (-40°C rated parts only)		70°C	< 10x rated
	2	-20°C	4 hours		
		Measure Cap, ESR, DCL			
	3	-10°C	4 hours		
		Measure Cap, ESR, DCL		Cap	
	4	0°C	4 hours	25°C	> 80% rated
		Measure Cap, ESR, DCL			
	5	25°C	4 hours	ESR	
		Measure Cap, ESR, DCL		-40°C	< 20x rated
	6	40°C	4 hours	-20°C	< 5x rated
	Measure Cap, ESR, DCL		-10°C	< 4x rated	
7	60°C	4 hours	70°C	< 1.3x rated	
	Measure Cap, ESR, DCL			< 1.3x rated	
8	70°C	4 hours			
	Measure Cap, ESR, DCL				
<b>Thermal Shock</b>	Step				
	1	Place cells into an oven at -20°C for 30 minutes	DCL	< 2.0x rated max.	
	2	In less than 15 seconds, move cells into a 70°C oven for 30 minutes	Cap	> 0.7x rated	
	3	Repeat 1 and 2 for 100 cycles	ESR	< 2.0x rated max.	
<b>Vibration</b>	Step				
	1	Apply a harmonic motion that is deflected 0.03 inches	DCL	< 2.0x rated max.	
	2	Vary frequency from 10 cycles per second to 55 cycles at a ramp rate of 1 Hz per minute	Cap	> 0.7x rated	
	3	Vibrate the cells in the X-Y direction for three hours	ESR	< 2.0x rated max.	
	4	Vibrate the cells in the Z direction for three hours			
5	Measure Cap, ESR and DCL				



# SECTION 4

## Application Notes



# BestCap® Ultra-low ESR High Power Pulse Supercapacitors



## Application Notes/BestCap® Construction/Voltage Drop

### 4.1: ELECTROCHEMICAL EDLC VS. ELECTRONIC TECHNOLOGY - BESTCAP® CONSTRUCTION

To understand the benefits offered by the BestCap®, it is necessary to examine how an electrochemical capacitor works. The most significant difference between an electronic capacitor and an electrochemical capacitor is that the charge transfer is carried out by the electrons in the former and by electrons and ions in the latter. The anions and cations involved in double layer supercapacitors are contained in the electrolyte which may be liquid (normally an aqueous or organic solution) or solid. The solid electrolyte is almost universally a conductive polymer.

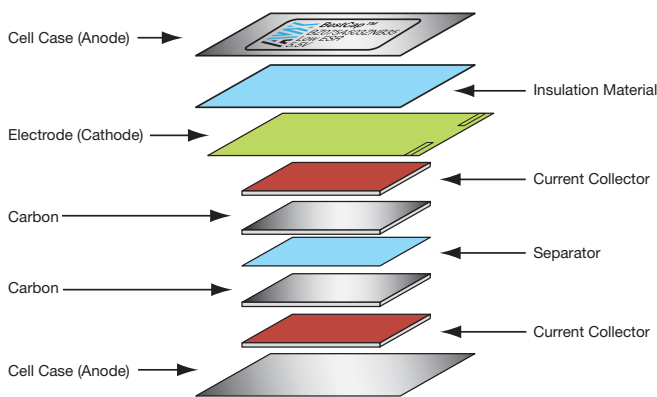

Electrons are relatively fast moving and therefore transfer charge “instantly.” However, ions have to move relatively slowly from anode to cathode, and hence a finite time is needed to establish the full nominal capacitance of the device. This nominal capacitance is normally measured at 1 second.

The differences between EDLC (Electrochemical Double Layer Capacitors) and electronic capacitors are summarized in the table below:

- A capacitor basically consists of two conductive plates (electrodes), separated by a layer of dielectric material.
- These dielectric materials may be ceramic, plastic film, paper, aluminum oxide, etc.
- EDLCs do not use a discrete dielectric interphase separating the electrodes.
- EDLCs utilize the charge separation, which is formed across the electrode – electrolyte interface.
- The EDLC constitutes of two types of charge carriers: IONIC species on the ELECTROLYTE side and ELECTRONIC species on the ELECTRODE side.

### 4.2: VOLTAGE DROP

Two factors are critical in determining the voltage drop when a capacitor delivers a short current pulse; these are ESR and “available” capacitance as shown in Figure 4.

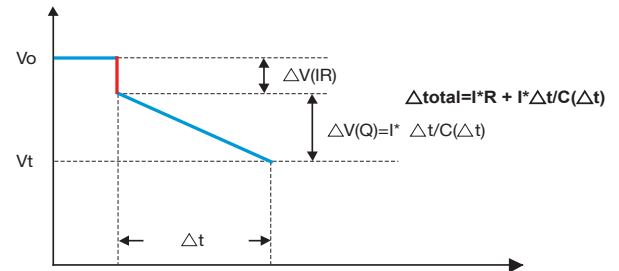

Figure 4. Voltage-time relation of capacitor unit

The instant voltage drop  $\Delta V_{ESR}$  is caused by and is directly proportional to the capacitor’s ESR. The continuing voltage drop with time  $\Delta V_C$ , is a function of the available charge, i.e. capacitance. From Figures 3 and 4 it is apparent that, for very short current pulses, e.g. in the millisecond region, the combination of voltage drops in a conventional supercapacitor caused by a) the high ESR and b) the lack of available capacitance causes a total voltage drop, unacceptable for most applications. Now compare the BestCap® performance under such pulse conditions. The ultra-low ESR (in milliOhms) minimizes the instantaneous voltage drop, while the very high retained capacitance drastically reduces the severity of the charge related drop. This is explained further in a later section.

### EFFICIENCY/TALKTIME BENEFITS OF BESTCAP®

Since BestCap®, when used in parallel with a battery, provides a current pulse with a substantially higher voltage than that available just from the battery as shown in Figure 5, the efficiency of the RF power amplifier is improved.

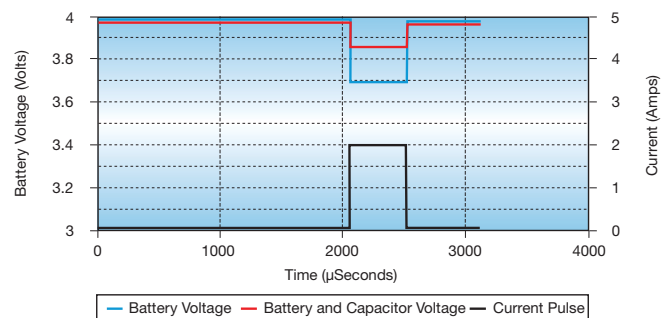

Figure 5. GSM Pulse

Additionally, the higher-than battery voltage supplied by the BestCap® keeps the voltage pulse above the “cut off voltage” limit for a significantly longer time than is the case for the battery alone. This increase in “talk time” is demonstrated in Figures 6(a) (Li-Ion at +25°C), and 6(b) (Li-Ion at 0°C).

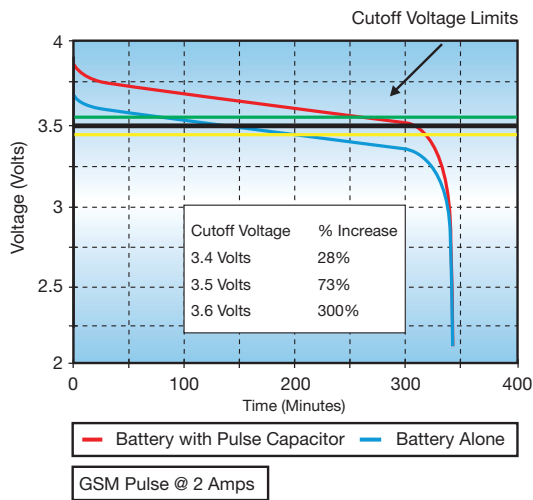

Figure 6a. Li-ION Battery at +25°C

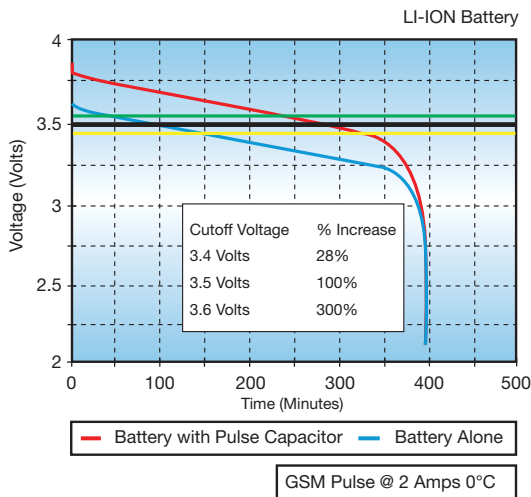

Figure 6b. Li-ION Battery at +0°C

## PULSE CAPACITOR APPLICATIONS

As mentioned earlier, the voltage drop in a circuit is critical as the circuit will not operate below a certain cut-off voltage. There are two sources of voltage drop ( $\Delta V$ ) which occur, the first  $\Delta V_{ESR}$  is because of the equivalent series resistance (ESR) and the second, called the capacitive drop, is  $\Delta V_C$ . From Ohm's law,

$$\text{voltage} = \text{current} \times \text{resistance} \text{ or } V = IR$$

Let us say that the instantaneous starting voltage is  $V_0$ , or voltage for the circuit from where the voltage drops. If the capacitor has an ESR of 100 milliOhms and the current is 1 amp,

$\Delta V_{ESR} = 1 \text{ amp} \times (0.100) \text{ ohms} = 0.1 \text{ volts}$  or 100 milli-volts. On demand, during the discharge mode, the voltage  $V = V_0$

$$- \Delta V_{ESR} = (V_0 - 0.1) \text{ volts}$$

The second voltage drop is because of the capacitance. This is shown in the equation as a linear function because of simplicity. Simply put,

$$Q \text{ (charge)} = C \text{ (capacitance)} \times V \text{ (voltage)}$$

$$\text{The derivative, } dQ/dt = I \text{ (current, in amps)} = C \times dV/dt$$

Hence,  $\Delta V_C$  (dV, the voltage drop because of capacitance) =  $I \times dt/C$ . This formula states that the larger the capacitance value the lower the voltage drop. Compared to a Ta capacitor, this  $\Delta V_C$  is reduced by a factor of about 10 to 100. So, BestCap® has an advantage where higher capacitance is needed. If the current pulse itself is 1 amp, the current pulse width is 1 second and the capacitance is 10 millifarads, the  $\Delta V_C = 1A \times 1\text{Sec}/0.01F$ , or a 100 volts; such an application is out of the range of BestCap®. However, if the pulse width becomes narrower, say 10 milliseconds, and the capacitance is 100 millifarads, the  $\Delta V_C = 1 \times (10/1000)/(100/1000) = 0.1 \text{ volt}$  or 100 millivolts. This shows the advantage of the large capacitance and hence the term "pulse" capacitor. The specific power – specific energy graphs are used in the battery industry to compare competitive products. As the dt becomes smaller i.e. 100 milliseconds, 10 milliseconds and then 1 millisecond, our estimates show that the specific power for the BestCap® is the highest as compared to our competitors because of our choice of internal materials chemistry.

**Conclusion:** we now clearly show that BestCap® has an advantage over competitors for short current pulse whose widths are smaller than a few hundred milliseconds.

# BestCap® Ultra-low ESR High Power Pulse Supercapacitors

## Enhancing the Power Capability of Primary Batteries



### 4.3 ENHANCING THE POWER CAPABILITY OF PRIMARY BATTERIES

When electronic equipment is powered by a primary (non rechargeable) battery, one of the limitations is the power capability of the battery.

In order to increase the available current from the battery while maintaining a constant voltage drop across the battery terminals, the designer must connect additional cells in parallel, leading to increased size and cost of both the battery and the finished product.

When high power is only required for short periods, more sophisticated approaches can be considered. The traditional approach involves using a high power rechargeable battery, charged by a low power primary cell.

A far superior solution, however, is the use of a BestCap® Supercapacitor, which is a device specifically designed to deliver high power.

BestCap® Supercapacitor benefits to the designer are:

- Substantially lower voltage drop for pulse durations of up to 100msec.
- Substantially lower voltage drop at cold temperatures (-20°C).
- Discharge current limited only by the ESR of the capacitor

The following analysis compares a primary battery connected in parallel to a Lithium Tionil Chloride, to the same primary battery connected to a BestCap® Supercapacitor. Various current pulses (amplitude and duration) are applied in each case.

#### BestCap® 5.5V 100mF

Pulse	Voltage Drop (mV) BestCap® Supercapacitors	Voltage Drop (mV) rechargeable battery
250mA / 1msec	25	150
500mA / 1msec	50	220
750mA / 1msec	75	150
200mA / 100msec at -20°C	232	470

#### BestCap® 3.5V 560mF

Pulse	Voltage Drop (mV) BestCap® Supercapacitors	Voltage Drop (mV) rechargeable battery
250mA / 100msec	50	190
500mA / 100msec	100	350
750mA / 100msec	152	190
1500mA / 1msec	43	220
1500mA / 100msec	305	350
750mA / 100msec at -20°C	172	470

#### Traditional design:

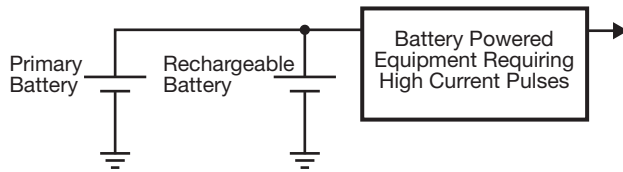

#### Design using BestCap®:

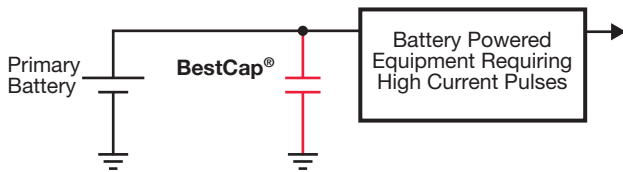

Additional Characteristics	BestCap®	Rechargeable Battery
Maximum discharge current (single pulse)	Not limited	5A Maximum
Number of Cycles	Not limited	40K to 400K (to retain 80% capacity)

# BestCap® Ultra-low ESR High Power Pulse Supercapacitors

## BestCap® for GSM/GPRS PCMCIA Modems



### 4.4 BESTCAP® FOR GSM/GPRS PCM- CIA MO- DEMS

There is an increasing usage of PCMCIA modem cards for wireless LAN and WAN (Wide Area Network) applications.

The PCMCIA card is used as an accessory to Laptops and PDAs and enables wide area mobile Internet access, including all associated applications like Email and file transfer.

With the widespread use of GSM networks, a PCMCIA GSM modem is a commonly used solution. To achieve higher speed data rates, GSM networks are now being upgraded to support the GPRS standard.

The design challenge:

GSM/GPRS transmission requires a current of approximately 2A for the pulse duration. The PCMCIA bus cannot supply this amount of pulsed current. Therefore, there is a need for a relatively large capacitance to bridge the gap.

The capacitor supplies the pulse current to the transmitter and is charged by a low current during the interval between pulses.

### THE SOLUTION:

	SOLUTION A	SOLUTION B
	Chip Tantalum	BestCap® BZ154B473ZSB
Rated Capacitance (milli Farad)	2.2	47
Capacitance @ 0.5msec Pulse (milli Farad)	2.2	30
Operating Voltage (V)	3.7	3.7
ESR (milli ohm)	50	160
Size (mm)	.4 x 7 x 2	20 x 15 x 2.1
Voltage Drop* (V) GPRS Pulse (25% duty cycle)	0.804V	0.268V
Voltage After Pulse (V)	2.896	3.432
Cutoff Voltage (V)	3.1	3.1
Pass/FAIL	FAIL	PASS

$$* V = V_1 + V_2 = 1.5A * ESR + (1.5A * 1.154msec) / C$$

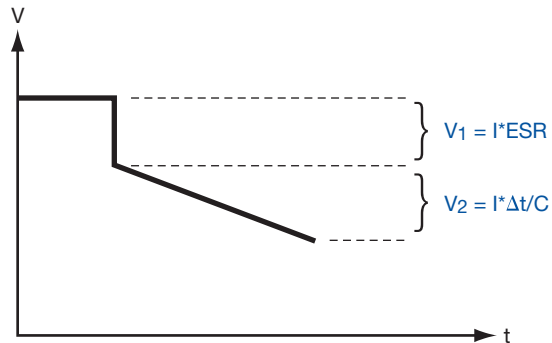
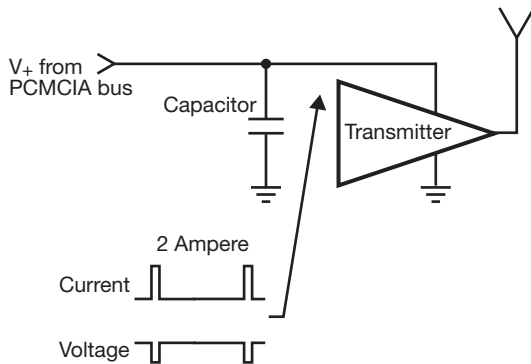

It is assumed that during the pulse, 0.5A is delivered by the battery and 1.5A by the capacitor.

**Conclusion:** High capacitance is needed to minimize voltage drop. A high value capacitance, even with a higher ESR, results in a lower voltage drop. Low voltage drop minimizes the conductive and emitted electro magnetic interference and increases transmitter output power and efficiency.



# SECTION 5

## Extended Temperature Range

# BestCap® Ultra-low ESR High Power Pulse Supercapacitors

## Extended Temperature Range



### SECTION 5: EXTENDED TEMPERATURE RANGE

AVX continues to expand the BestCap® product offerings for additional applications. For applications demanding other temperature ratings, AVX offers special construction techniques for high and low temperature performance upon request.

AVX offers temperature range extensions as follows:

- -40°C to 70°C, -20°C to 75°C and -40°C to 75°C.

AVX has extensive experience in manufacturing these alternate temperature rating parts. Contact AVX for your special temperature requirements.

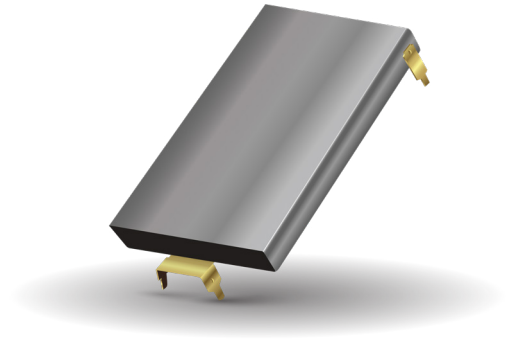

# BestCap® Ultra-low ESR High Power Pulse Supercapacitors

## Product Listing



### PASSIVES

#### Capacitors

Multilayer Ceramic  
Film  
Glass  
Niobium Oxide\* - OxiCap®  
Pulse Supercapacitors  
Tantalum

#### Circuit Protection

Thermistors  
Fuses - Thin Film  
Transient Voltage Suppressors  
Varistors - Zinc Oxide

#### Directional Couplers

Thin-Film

#### Filters

Ceramic  
EMI  
Noise  
SAW  
Low Pass - Thin Film

#### Inductors

Thin-Film

#### Integrated Passive Components

PMC - Thin-Film Networks  
Capacitor Arrays  
Feedthru Arrays  
Low Inductance Decoupling Arrays

#### Piezo Acoustic Generators

Ceramic

#### Resistors

Arrays  
Miniature Axials

#### Timing Devices

Clock Oscillators  
MHz Quartz Crystal  
Resonators  
VCO  
TCXO

### CONNECTORS

Automotive  
Standard, Custom  
Board to Board  
SMD (0.4, 0.5, 1.0mm), BGA, Thru-Hole  
Card Edge  
DIN41612  
Standard, Inverse, High Temperature  
FFC/FPC  
0.3, 0.5, 1.0mm  
Hand Held, Cellular  
Battery, I/O, SIMcard, RF shield clips  
2mm Hard Metric  
Standard, Reduced Cross-Talk

IDC Wire to Board  
Headers, Plugs, Assemblies  
Memory  
PCMCIA, Compact Flash, Secure Digital, MMC,  
Smartcard, SODIMM  
Military  
H Government, DIN41612  
Polytect™  
Soft Molding  
Rack and Panel  
Varicon™

NOTICE: Specifications are subject to change without notice. Contact your nearest AVX Sales Office for the latest specifications. All statements, information and data given herein are believed to be accurate and reliable, but are presented without guarantee, warranty, or responsibility of any kind, expressed or implied. Statements or suggestions concerning possible use of our products are made without representation or warranty that any such use is free of patent infringement and are not recommendations to infringe any patent. The user should not assume that all safety measures are indicated or that other measures may not be required. Specifications are typical and may not apply to all applications.

© AVX Corporation

"Niobium Oxide Capacitors are manufactured and sold under patent license from Cabot Corporation, Boyertown, Pennsylvania U.S.A."

## **FOLLOW US:**

---

VISIT US AT



A light gray world map is centered on the page. Overlaid on the map are five regional labels in bold black text, each with a corresponding telephone number. The regions are North America, Central America, Europe, Asia, and Japan. The labels are positioned over their respective geographical areas.

### **North America**

Tel: +1 864-967-2150

### **Europe**

Tel: +44 1276-697000

### **Asia**

Tel: +65 6286-7555

### **Central America**

Tel: +55 11-46881960

### **Japan**

Tel: +81 740-321250



单击下面可查看定价，库存，交付和生命周期等信息

[>>AVX](#)