



# SMD Power Inductors



---

## IMPORTANT INFORMATION/DISCLAIMER

All product specifications, statements, information and data (collectively, the “Information”) in this datasheet or made available on the website are subject to change. The customer is responsible for checking and verifying the extent to which the Information contained in this publication is applicable to an order at the time the order is placed. All Information given herein is believed to be accurate and reliable, but it is presented without guarantee, warranty, or responsibility of any kind, expressed or implied.

Statements of suitability for certain applications are based on AVX’s knowledge of typical operating conditions for such applications, but are not intended to constitute and AVX specifically disclaims any warranty concerning suitability for a specific customer application or use.

**ANY USE OF PRODUCT OUTSIDE OF SPECIFICATIONS OR ANY STORAGE OR INSTALLATION INCONSISTENT WITH PRODUCT GUIDANCE VOIDS ANY WARRANTY.**

The Information is intended for use only by customers who have the requisite experience and capability to determine the correct products for their application. Any technical advice inferred from this Information or otherwise provided by AVX with reference to the use of AVX’s products is given without regard, and AVX assumes no obligation or liability for the advice given or results obtained.

Although AVX designs and manufactures its products to the most stringent quality and safety standards, given the current state of the art, isolated component failures may still occur. Accordingly, customer applications which require a high degree of reliability or safety should employ suitable designs or other safeguards (such as installation of protective circuitry or redundancies) in order to ensure that the failure of an electrical component does not result in a risk of personal injury or property damage.

Unless specifically agreed to in writing, AVX has not tested or certified its products, services or deliverables for use in high risk applications including medical life support, medical device, direct physical patient contact, water treatment, nuclear facilities, weapon systems, mass and air transportation control, flammable environments, or any other potentially life critical uses. Customer understands and agrees that AVX makes no assurances that the products, services or deliverables are suitable for any high-risk uses. Under no circumstances does AVX warrant or guarantee suitability for any customer design or manufacturing process.

Although all product–related warnings, cautions and notes must be observed, the customer should not assume that all safety measures are indicated or that other measures may not be required.

# SMD Power Inductor

## Table of Contents

### LMax SMD Power Inductor



#### LMXN Series – Non-Shielded Style B .... 1

Inductance Range: 0.47 - 470  $\mu$ H  
Rated Current: 0.53 - 30 A



#### LMXN Series – Non-Shielded Style C .... 3

Inductance Range: 0.47 - 470  $\mu$ H  
Rated Current: 0.53 - 30 A



#### LMXN Series – Non-Shielded Style D .... 7

Inductance Range: 0.47 - 470  $\mu$ H  
Rated Current: 0.53 - 30 A

### LMax SMD Shielded Power Inductor



#### LMXS Series – Shielded Style B ..... 11

Inductance Range: 0.47 - 470  $\mu$ H  
Rated Current: 0.53 - 30 A



#### LMXS Series – Shielded Style C ..... 15

Inductance Range: 0.47 - 470  $\mu$ H  
Rated Current: 0.53 - 30 A



#### LMXS Series – Shielded Style D ..... 19

Inductance Range: 0.47 - 470  $\mu$ H  
Rated Current: 0.53 - 30 A



#### LMXS Series – Shielded Style F ..... 22

Inductance Range: 0.47 - 470  $\mu$ H  
Rated Current: 0.53 - 30 A



#### LMXS Series – Shielded Style G ..... 26

Inductance Range: 0.47 - 470  $\mu$ H  
Rated Current: 0.53 - 30 A



#### LMXS Series – Shielded Style H ..... 28

Inductance Range: 0.47 - 470  $\mu$ H  
Rated Current: 0.53 - 30 A



#### LMXS Series – Shielded Style J ..... 31

Inductance Range: 0.47 - 470  $\mu$ H  
Rated Current: 0.53 - 30 A



#### LMXS Series – Shielded Style L ..... 33

Inductance Range: 0.47 - 470  $\mu$ H  
Rated Current: 0.53 - 30 A



#### LMXS Series – Shielded Style M ..... 35

Inductance Range: 0.47 - 470  $\mu$ H  
Rated Current: 0.53 - 30 A



#### LMXS Series – Shielded Style P ..... 37

Inductance Range: 0.47 - 470  $\mu$ H  
Rated Current: 0.53 - 30 A

### LMax SMD Miniature Power Inductor



#### LMMN Series – Miniature Style M ..... 41

Inductance Range: 0.47 - 470  $\mu$ H  
Rated Current: 0.53 - 30 A

### LMax Low Profile Power Inductor



#### LMLP Series – Style C ..... 49

Inductance Range: 0.47 - 470  $\mu$ H  
Rated Current: 0.53 - 30 A



#### LMLP Series – Style D ..... 57

Inductance Range: 0.47 - 470  $\mu$ H  
Rated Current: 0.53 - 30 A

NOTICE: Specifications are subject to change without notice. Contact your nearest AVX Sales Office for the latest specifications. All statements, information and data given herein are believed to be accurate and reliable, but are presented without guarantee, warranty, or responsibility of any kind, expressed or implied. Statements or suggestions concerning possible use of our products are made without representation or warranty that any such use is free of patent infringement and are not recommendations to infringe any patent. The user should not assume that all safety measures are indicated or that other measures may not be required. Specifications are typical and may not apply to all applications.

# LMax SMD Power Inductor

## LMXN Series – Non-Shielded Style B



### FEATURES

- Miniature surface mount design
- High power, High saturation inductors
- Very low resistance
- Maximum power density
- Ideal inductors for DC–DC converters
- Available on tape and reel for auto surface mounting

### APPLICATIONS

- Notebook Computers
- Handheld Communications
- LCD Televisions
- Power Supply For VTRs
- DC/DC Converters, etc.

### CHARACTERISTICS

- Saturation Rated Current: The current when the inductance becomes 30% lower than its initial value. (Ta=25°C)
- Operating temperature range: -40 ~ 85°C

### INDUCTANCE AND RATED CURRENT RANGES

- 0705 0.47μH ~ 22.0μH 7.7 ~ 0.70A
- 0906 0.56μH ~ 100μH 7.7 ~ 0.53A
- 1310 0.47μH ~ 100μH 11.4 ~ 0.95A
- 1913 0.47μH ~ 100μH 25.1 ~ 1.80A
- 2216 0.78μH ~ 470μH 30.0 ~ 0.8A
- Electrical specifications at 25°C



### DIMENSIONS

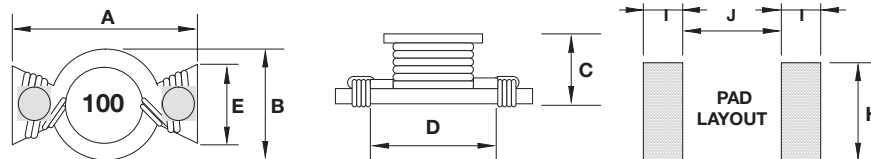

mm (inches)

Type	A max.	B max.	C max.	D	E	H	I	J
0705	7.50 (0.295)	5.20 (0.205)	3.20 (0.126)	4.60 (0.181)	2.50 (0.098)	4.00 (0.157)	2.00 (0.079)	4.00 (0.157)
0906	8.89 (0.350)	6.40 (0.252)	5.00 (0.197)	5.84 (0.230)	2.60 (0.103)	4.06 (0.160)	2.00 (0.079)	5.08 (0.200)
1310	13.20 (0.560)	9.90 (0.390)	6.35 (0.250)	9.50 (0.374)	4.50 (0.177)	6.50 (0.256)	2.30 (0.091)	9.00 (0.344)
1913	19.40 (0.764)	13.30 (0.524)	6.80 (0.268)	12.7 (0.500)	6.60 (0.260)	8.00 (0.315)	3.80 (0.150)	11.7 (0.460)
2216	22.35 (0.880)	16.26 (0.604)	8.00 (0.315)	16.0 (0.630)	8.00 (0.315)	8.64 (0.340)	4.30 (0.169)	14.35 (0.565)

### HOW TO ORDER

<b>LM</b>	<b>XN</b>	<b>0705</b>	<b>M</b>	<b>R04</b>	<b>B</b>	<b>T</b>	<b>A</b>	<b>S</b>
<b>Family</b>	<b>Series</b>	<b>Size</b>	<b>Tolerance</b>	<b>Inductance</b>	<b>Style</b>	<b>Termination</b>	<b>Special</b>	<b>Packaging</b>
LM = Power Inductor	XN = Non-Shielded	0705 = 7x5xh (h = see catalog)	M = ±20% P = +40% -20%	R04 = 0.039μH R39 = 0.390μH 3R9 = 3.900μH 390 = 39.00μH 391 = 390.0μH 392 = 3900μH		T = Sn Plate	A = Standard	S = 13" Reel



The Important Information/Disclaimer is incorporated in the catalog where these specifications came from or available online at [www.avx.com/disclaimer/](http://www.avx.com/disclaimer/) by reference and should be reviewed in full before placing any order.

# LMax SMD Power Inductor

## LMXN Series – Non-Shielded Style B



### ELECTRICAL CHARACTERISTICS

0705/0906/1310/1913/2216

Codes	L ( $\mu$ H)	Tolerance			Test Condition	DCR ( $\Omega$ ) max.					I sat (A) max*				
		705	0906 2216	1310 1913		0705	0906	1310	1913	2216	0705	0906	1310	1913	2216
R47	0.47	P	-	P	100KHz, 0.1V	0.025	-	0.005	0.003	-	7.7	-	11.4	25.1	-
R56	0.56	-	M	-	100KHz, 0.1V	-	0.010	-	-	-	-	7.7	-	-	-
R78	0.78	-	M	-	100KHz, 0.1V	-	-	-	-	0.003	-	-	-	-	30
1R0	1.0	M	-	P	100KHz, 0.1V	0.050	-	0.006	0.004	-	2.9	-	9.9	15.3	-
1R5	1.5	M	M	P	100KHz, 0.1V	0.050	-	0.008	0.006	0.004	2.6	-	7.9	12	25
2R2	2.2	M	M	M	100KHz, 0.1V	0.070	0.035	0.011	0.008	0.006	2.3	3.5	6.1	10.2	20
3R3	3.3	M	M	M	100KHz, 0.1V	0.080	0.040	0.014	0.009	0.009	2	3	5.1	9.3	17
3R9	3.9	-	M	-	100KHz, 0.1V	-	-	-	-	0.010	-	-	-	-	15
4R7	4.7	M	M	M	100KHz, 0.1V	0.090	0.054	0.018	0.012	0.014	1.5	2.6	4.2	7.7	13
6R0	6.0	-	M	-	100KHz, 0.1V	-	-	-	-	0.017	-	-	-	-	12
6R8	6.8	M	M	M	100KHz, 0.1V	0.130	0.08	0.027	0.019	-	1.2	2.2	3.6	6.2	-
7R8	7.8	-	M	-	100KHz, 0.1V	-	-	-	-	0.018	-	-	-	-	11
100	10	M	M	M	100KHz, 0.1V	0.160	0.111	0.038	0.027	0.026	1.1	1.9	3.3	5.2	10
150	15	M	M	M	100KHz, 0.1V	0.230	0.170	0.045	0.032	0.032	0.9	1.5	2.4	4.3	8
220	22	M	M	M	100KHz, 0.1V	0.370	0.250	0.070	0.050	0.043	0.7	1.2	2	3.7	7
330	33	-	M	M	100KHz, 0.1V	-	0.350	0.100	0.069	0.066	-	0.99	1.7	3	6
470	47	-	M	M	100KHz, 0.1V	-	0.470	0.150	0.109	0.096	-	0.87	1.4	2.4	5
680	68	-	M	M	100KHz, 0.1V	-	0.730	0.220	0.156	0.115	-	0.68	1.2	2	4
101	100	-	M	M	100KHz, 0.1V	-	1.110	0.280	0.206	0.165	-	0.53	0.95	1.8	3
221	220	-	M	-	100KHz, 0.1V	-	-	-	-	0.396	-	-	-	-	2.4
331	330	-	M	-	100KHz, 0.1V	-	-	-	-	0.588	-	-	-	-	1
471	470	-	M	-	100KHz, 0.1V	-	-	-	-	0.950	-	-	-	-	0.8

\*Saturation Current: The current when the inductance becomes 30% lower than its initial value. (Ta=25°C)

# LMax SMD Power Inductor

## LMXN Series – Non-Shielded Style C

### FEATURES

- High power, High saturation inductors
- Ideal inductors for DC-DC converters in notebook computers, PDAs, Step-up or step-down converters, flash memory programmers, etc.
- 0705 has ceramic base with gold-plating
- Others have LCP plastic base

### APPLICATIONS

- Portable Telephones
- Personal Computers
- DC/DC Converters
- Various Electronic Appliances

### DIMENSIONS

### CHARACTERISTICS

- Saturation Rated Current: The current when the inductance becomes 10% lower than its initial value. (Ta=25°C)
- Operating temperature range: -40 ~ 125°C

### INDUCTANCE AND RATED CURRENT RANGES

- 0705 1.0μH ~ 1000μH 2.9 ~ 0.10A
- 1309 4.7μH ~ 1000μH 4.2 ~ 0.29A
- 13E9 1.0μH ~ 1000μH 9.0 ~ 0.30A
- 13L9 0.47μH ~ 1000μH 40 ~ 0.8A
- 1915 1.0μH ~ 1000μH 20 ~ 1.0A
- Electrical specifications at 25°C

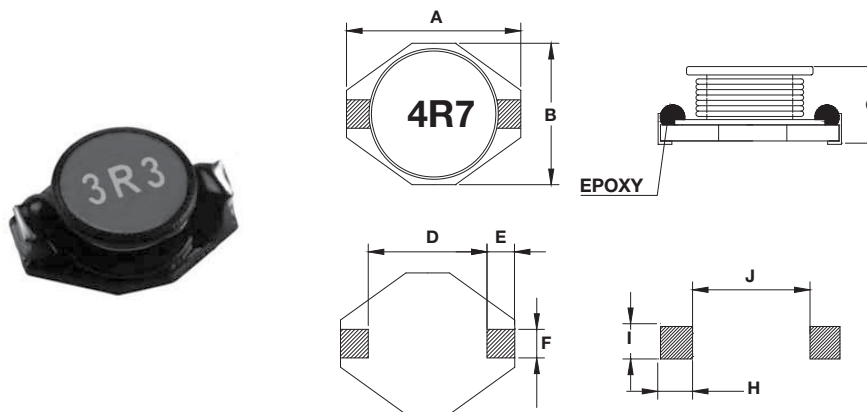

mm (inches)

Type	A max.	B max.	C max.	D	E	F	H	I	J
0705	6.60 (0.260)	4.45 (0.175)	2.92 (0.115)	4.32 (0.170)	1.27 (0.050)	1.02 (0.040)	3.56 (0.140)	1.40 (0.055)	4.06 (0.160)
1309	12.95 (0.510)	9.40 (0.370)	3.00 (0.118)	7.62 (0.300)	2.54 (0.100)	2.54 (0.100)	2.79 (0.110)	2.92 (0.115)	7.37 (0.290)
13E9	12.95 (0.510)	9.40 (0.370)	5.21 (0.205)	7.62 (0.300)	2.54 (0.100)	2.54 (0.100)	2.79 (0.110)	2.92 (0.115)	7.37 (0.290)
13L9	12.95 (0.510)	9.40 (0.370)	11.43 (0.450)	7.62 (0.300)	2.54 (0.100)	2.54 (0.100)	2.79 (0.110)	2.92 (0.115)	7.37 (0.290)
1915	18.54 (0.730)	15.24 (0.600)	7.11 (0.280)	12.7 (0.500)	2.54 (0.100)	2.54 (0.100)	2.79 (0.110)	2.92 (0.115)	12.45 (0.490)

### HOW TO ORDER

<b>LM</b>	<b>XN</b>	<b>1309</b>	<b>M</b>	<b>R04</b>	<b>C</b>	<b>T</b>	<b>A</b>	<b>S</b>
Family	Series	Size	Tolerance	Inductance	Style	Termination	Special	Packaging
LM = Power Inductor	XN = Non-Shielded	1309 = 13x9xh 13E9 = 13x9xE(h) (h = see catalog)	M = ±20% N = ±30%	R04 = 0.039μH R39 = 0.390μH 3R9 = 3.900μH 390 = 39.00μH 391 = 390.0μH 392 = 3900μH		T = Sn Plate	A = Standard	S = 13" Reel

# LMax SMD Power Inductor

## LMXN Series – Non-Shielded Style C

### ELECTRICAL CHARACTERISTICS

#### 0705

Codes	L (μH)	Tolerance	Test Condition	DCR (Ω) max.	I sat (A) max*
1R0	1.0	M	100KHz, 0.1V	0.05	2.90
1R5	1.5	M	100KHz, 0.1V	0.06	2.60
2R2	2.2	M	100KHz, 0.1V	0.07	2.30
3R3	3.3	M	100KHz, 0.1V	0.08	2.00
4R7	4.7	M	100KHz, 0.1V	0.09	1.50
6R8	6.8	M	100KHz, 0.1V	0.13	1.20
8R2	8.2	M	100KHz, 0.1V	0.16	1.15
100	10	M	100KHz, 0.1V	0.16	1.10
150	15	M	100KHz, 0.1V	0.23	0.90
220	22	M	100KHz, 0.1V	0.37	0.70
330	33	M	100KHz, 0.1V	0.51	0.58
470	47	M	100KHz, 0.1V	0.64	0.50
680	68	M	100KHz, 0.1V	0.86	0.40
101	100	M	100KHz, 0.1V	1.27	0.31
151	150	M	100KHz, 0.1V	2.00	0.27
221	220	M	100KHz, 0.1V	3.11	0.22
331	330	M	100KHz, 0.1V	3.80	0.18
471	470	M	100KHz, 0.1V	5.06	0.16
681	680	M	100KHz, 0.1V	9.20	0.14
102	1000	M	100KHz, 0.1V	13.8	0.10

#### 10309

Codes	L (μH)	Tolerance	Test Condition	DCR (Ω) max.	I sat (A) max*
4R7	4.7	M	100KHz, 0.1V	0.036	4.20
6R8	6.8	M	100KHz, 0.1V	0.060	3.90
100	10	M	100KHz, 0.1V	0.085	2.70
150	15	M	100KHz, 0.1V	0.12	2.30
220	22	M	100KHz, 0.1V	0.18	1.80
330	33	M	100KHz, 0.1V	0.25	1.60
470	47	M	100KHz, 0.1V	0.32	1.30
680	68	M	100KHz, 0.1V	0.54	1.10
101	100	M	100KHz, 0.1V	0.69	0.87
151	150	M	100KHz, 0.1V	0.94	0.74
221	220	M	100KHz, 0.1V	1.60	0.56
331	330	M	100KHz, 0.1V	2.15	0.50
471	470	M	100KHz, 0.1V	3.30	0.40
681	680	M	100KHz, 0.1V	4.40	0.33
102	1000	M	100KHz, 0.1V	7.00	0.29

\*Saturation Current: The current when the inductance becomes 10% lower than its initial value. (Ta=25°C)

# LMax SMD Power Inductor

## LMXN Series – Non-Shielded Style C

### 13E9

Codes	L (μH)	Tolerance	Test Condition	DCR (Ω) max.	I sat (A) max*
1R0	1.0	M	100KHz, 0.1V	0.009	9.00
1R5	1.5	M	100KHz, 0.1V	0.010	8.00
2R2	2.2	M	100KHz, 0.1V	0.012	7.00
3R3	3.3	M	100KHz, 0.1V	0.015	6.40
4R7	4.7	M	100KHz, 0.1V	0.018	5.40
6R8	6.8	M	100KHz, 0.1V	0.027	4.60
100	10	M	100KHz, 0.1V	0.038	3.80
150	15	M	100KHz, 0.1V	0.046	3.00
220	22	M	100KHz, 0.1V	0.085	2.60
330	33	M	100KHz, 0.1V	0.100	2.00
470	47	M	100KHz, 0.1V	0.140	1.60
680	68	M	100KHz, 0.1V	0.200	1.40
101	100	M	100KHz, 0.1V	0.280	1.20
151	150	M	100KHz, 0.1V	0.400	1.00
221	220	M	100KHz, 0.1V	0.610	0.80
331	330	M	100KHz, 0.1V	1.020	0.60
471	470	M	100KHz, 0.1V	1.270	0.50
681	680	M	100KHz, 0.1V	2.020	0.40
102	1000	M	100KHz, 0.1V	3.000	0.30

### 13L9

Codes	L (μH)	Tolerance	Test Condition	DCR (Ω) max.	I sat (A) max*
R47	0.47	N	100KHz, 0.1V	0.008	40.0
R82	0.82	N	100KHz, 0.1V	0.009	34.7
1R2	1.2	N	100KHz, 0.1V	0.010	28.4
1R5	1.5	N	100KHz, 0.1V	0.010	25.7
2R2	2.2	N	100KHz, 0.1V	0.012	23.0
3R5	3.5	N	100KHz, 0.1V	0.015	21.0
4R7	4.7	N	100KHz, 0.1V	0.020	18.0
5R6	5.6	N	100KHz, 0.1V	0.022	16.0
6R8	6.8	N	100KHz, 0.1V	0.030	15.0
8R2	8.2	N	100KHz, 0.1V	0.033	10.0
100	10	M	100KHz, 0.1V	0.040	8.00
150	15	M	100KHz, 0.1V	0.050	7.00
220	22	M	100KHz, 0.1V	0.066	5.50
330	33	M	100KHz, 0.1V	0.080	4.00
470	47	M	100KHz, 0.1V	0.11	3.80
680	68	M	100KHz, 0.1V	0.17	3.00
101	100	M	100KHz, 0.1V	0.22	2.50
151	150	M	100KHz, 0.1V	0.34	2.00
221	220	M	100KHz, 0.1V	0.44	1.60
331	330	M	100KHz, 0.1V	0.70	1.20
471	470	M	100KHz, 0.1V	0.95	1.00
681	680	M	100KHz, 0.1V	1.20	1.00
102	1000	M	100KHz, 0.1V	2.00	0.80

\*Saturation Current: The current when the inductance becomes 10% lower than its initial value. (Ta=25°C)



# LMax SMD Power Inductor

## LMXN Series – Non-Shielded Style C



### 1915

Codes	L (μH)	Tolerance	Test Condition	DCR (Ω) max.	I sat (A) max*
1R0	1.0	M	100KHz, 0.1V	0.009	20
2R2	2.2	M	100KHz, 0.1V	0.014	16
3R3	3.3	M	100KHz, 0.1V	0.018	14
5R6	5.6	M	100KHz, 0.1V	0.020	12
100	10	M	100KHz, 0.1V	0.031	10
150	15	M	100KHz, 0.1V	0.036	8.0
220	22	M	100KHz, 0.1V	0.047	7.0
330	33	M	100KHz, 0.1V	0.066	5.5
470	47	M	100KHz, 0.1V	0.095	4.5
680	68	M	100KHz, 0.1V	0.130	3.5
101	100	M	100KHz, 0.1V	0.190	3.0
151	150	M	100KHz, 0.1V	0.250	2.6
221	220	M	100KHz, 0.1V	0.380	2.4
331	330	M	100KHz, 0.1V	0.560	1.9
471	470	M	100KHz, 0.1V	0.850	1.4
681	680	M	100KHz, 0.1V	1.100	1.2
102	1000	M	100KHz, 0.1V	1.800	1.0

\*Saturation Current: The current when the inductance becomes 10% lower than its initial value. (Ta=25°C)

# LMax SMD Power Inductor

## LMXN Series – Non-Shielded Style D

### FEATURES

- Open Magnetic Circuit Construction
- Small Surface Area

### APPLICATIONS

- LCD Televisions
- Notebooks
- Portable Communication
- DC/DC Converters, etc.

### CHARACTERISTICS

- Rated Current (IDC): The DC current that will cause an approximate  $\Delta T$  of 40°C. (Ta=25°C)
- Operating temperature range: -40°C ~ +125°C

### INDUCTANCE AND RATED CURRENT RANGES

- 0504 1.0 $\mu$ H ~ 33  $\mu$ H 3.30 ~ 0.56A
- 0605 10.0 $\mu$ H ~ 220  $\mu$ H 1.44 ~ 0.35A
- 0808 10.0 $\mu$ H ~ 330  $\mu$ H 1.44 ~ 0.28A
- 08G8 10.0 $\mu$ H ~ 470  $\mu$ H 2.30 ~ 0.34A
- 1009 10.0 $\mu$ H ~ 560  $\mu$ H 2.38 ~ 0.32A
- 10F9 10.0 $\mu$ H ~ 820  $\mu$ H 2.6 ~ 0.24A
- Electrical specifications at 25°C



### DIMENSIONS

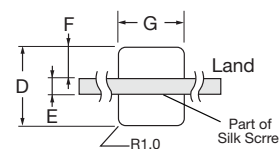
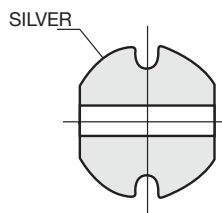
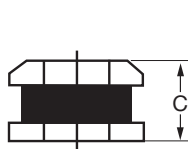
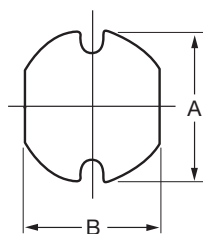

mm (inches)

Type	A	B	C	D	E	F	G
0504	4.50 ± 0.30 (0.177 ± .012)	4.00 ± 0.30 (0.158 ± 0.012)	3.20 ± 0.30 (0.126 ± 0.012)	5.00 (0.197)	1.50 (0.059)	1.75 (0.069)	4.50 (0.177)
0605	5.80 ± 0.30 (0.228 ± .012)	5.20 ± 0.30 (0.205 ± 0.012)	4.50 ± 0.35 (0.177 ± 0.014)	6.00 (0.236)	1.70 (0.067)	2.15 (0.085)	5.50 (0.217)
0808	7.80 ± 0.30 (0.307 ± .012)	7.30 ± 0.30 (0.276 ± 0.012)	3.50 ± 0.50 (0.140 ± 0.020)	8.00 (0.315)	2.00 (0.079)	3.00 (0.118)	7.50 (0.295)
08G8	7.80 ± 0.30 (0.307 ± .012)	7.30 ± 0.30 (0.287 ± 0.012)	5.08 ± 0.50 (0.200 ± 0.020)	8.00 (0.315)	2.00 (0.079)	3.00 (0.118)	7.50 (0.295)
1009	10.0 ± 0.30 (0.394 ± .012)	9.00 ± 0.30 (0.354 ± 0.012)	4.00 ± 0.50 (0.158 ± 0.020)	10.0 (0.394)	2.50 (0.098)	3.75 (0.148)	9.50 (0.374)
10F9	10.0 ± 0.40 (0.394 ± .016)	9.00 ± 0.40 (0.354 ± 0.016)	5.40 ± 0.40 (0.213 ± 0.016)	10.0 (0.394)	2.50 (0.098)	3.75 (0.148)	9.50 (0.374)

### HOW TO ORDER

<b>LM</b>	<b>XN</b>	<b>1009</b>	<b>M</b>	<b>R04</b>	<b>D</b>	<b>T</b>	<b>A</b>	<b>S</b>
Family	Series	Size	Tolerance	Inductance	Style	Termination	Special	Packaging
LM = Power Inductor	XN = Non-Shielded	1009 = 10x9xh 10F9 = 10x9xF(h) (h = see catalog)	M = ±20%	1R0 = 1.00 $\mu$ H 390 = 39.00 $\mu$ H 391 = 390.0 $\mu$ H		T = Sn Plate	A = Standard	S = 13" Reel

# LMax SMD Power Inductor

## LMXN Series – Non-Shielded Style D

### ELECTRICAL CHARACTERISTICS

#### 0504

Codes	L (μH)	Tolerance	Test Condition	DCR (Ω) max.	IDC (A) max.
1R0	1.0	M	100KHz, 1.0V	0.048	3.30
1R4	1.4	M	100KHz, 1.0V	0.056	2.80
1R8	1.8	M	100KHz, 1.0V	0.063	2.45
2R2	2.2	M	100KHz, 1.0V	0.071	2.21
2R7	2.7	M	100KHz, 1.0V	0.078	2.00
3R3	3.3	M	100KHz, 1.0V	0.086	1.81
3R9	3.9	M	100KHz, 1.0V	0.093	1.66
4R7	4.7	M	100KHz, 1.0V	0.108	1.51
5R6	5.6	M	100KHz, 1.0V	0.125	1.40
6R8	6.8	M	100KHz, 1.0V	0.131	1.26
8R2	8.2	M	100KHz, 1.0V	0.146	1.14
100	10	M	100KHz, 1.0V	0.182	1.04
120	12	M	100KHz, 1.0V	0.210	0.97
150	15	M	100KHz, 1.0V	0.235	0.85
180	18	M	100KHz, 1.0V	0.338	0.74
220	22	M	100KHz, 1.0V	0.378	0.68
270	27	M	100KHz, 1.0V	0.522	0.62
330	33	M	100KHz, 1.0V	0.540	0.56

#### 0605

Codes	L (μH)	Tolerance	Test Condition	DCR (Ω) max.	IDC (A) max.
100	10	M	100KHz, 1.0V	0.100	1.44
120	12	M	100KHz, 1.0V	0.120	1.40
150	15	M	100KHz, 1.0V	0.140	1.30
180	18	M	100KHz, 1.0V	0.150	1.23
220	22	M	100KHz, 1.0V	0.180	1.11
270	27	M	100KHz, 1.0V	0.200	0.97
330	33	M	100KHz, 1.0V	0.230	0.88
390	39	M	100KHz, 1.0V	0.320	0.80
470	47	M	100KHz, 1.0V	0.370	0.72
560	56	M	100KHz, 1.0V	0.420	0.68
680	68	M	100KHz, 1.0V	0.460	0.61
820	82	M	100KHz, 1.0V	0.600	0.58
101	100	M	100KHz, 1.0V	0.700	0.52
121	120	M	100KHz, 1.0V	0.930	0.48
151	150	M	100KHz, 1.0V	1.100	0.40
181	180	M	100KHz, 1.0V	1.380	0.38
221	220	M	100KHz, 1.0V	1.570	0.35

# LMax SMD Power Inductor

## LMXN Series – Non-Shielded Style D

### 0808

Codes	L (μH)	Tolerance	Test Condition	DCR (Ω) max.	IDC (A) max.
100	10	M	100KHz, 1.0V	1.44	0.081
120	12	M	100KHz, 1.0V	1.39	0.089
150	15	M	100KHz, 1.0V	1.24	0.104
180	18	M	100KHz, 1.0V	1.12	0.111
220	22	M	100KHz, 1.0V	1.07	0.129
270	27	M	100KHz, 1.0V	0.94	0.153
330	33	M	100KHz, 1.0V	0.85	0.170
390	39	M	100KHz, 1.0V	0.74	0.217
470	47	M	100KHz, 1.0V	0.68	0.252
560	56	M	100KHz, 1.0V	0.64	0.282
680	68	M	100KHz, 1.0V	0.59	0.332
820	82	M	100KHz, 1.0V	0.54	0.406
101	100	M	100KHz, 1.0V	0.51	0.481
121	120	M	100KHz, 1.0V	0.49	0.536
151	150	M	100KHz, 1.0V	0.40	0.755
181	180	M	100KHz, 1.0V	0.36	1.022
221	220	M	100KHz, 1.0V	0.31	1.200
271	270	M	100KHz, 1.0V	0.29	1.306
331	330	M	100KHz, 1.0V	0.28	1.495

### 08G8

Codes	L (μH)	Tolerance	Test Condition	DCR (Ω) max.	IDC (A) max.
100	10	M	100KHz, 1.0V	0.070	2.30
120	12	M	100KHz, 1.0V	0.080	2.00
150	15	M	100KHz, 1.0V	0.090	1.80
180	18	M	100KHz, 1.0V	0.100	1.60
220	22	M	100KHz, 1.0V	0.110	1.50
270	27	M	100KHz, 1.0V	0.120	1.30
330	33	M	100KHz, 1.0V	0.130	1.20
470	47	M	100KHz, 1.0V	0.180	1.00
560	56	M	100KHz, 1.0V	0.240	0.94
680	68	M	100KHz, 1.0V	0.280	0.85
820	82	M	100KHz, 1.0V	0.370	0.78
101	100	M	100KHz, 1.0V	0.430	0.72
121	120	M	100KHz, 1.0V	0.470	0.66
151	150	M	100KHz, 1.0V	0.640	0.58
221	220	M	100KHz, 1.0V	0.960	0.49
331	330	M	100KHz, 1.0V	1.260	0.40
391	390	M	100KHz, 1.0V	1.770	0.36
471	470	M	100KHz, 1.0V	1.960	0.34

# LMax SMD Power Inductor

## LMXN Series – Non-Shielded Style D

### 1009

Codes	L (μH)	Tolerance	Test Condition	DCR (Ω) max.	IDC (A) max.
100	10	M	100KHz, 1.0V	0.053	2.38
120	12	M	100KHz, 1.0V	0.061	2.13
150	15	M	100KHz, 1.0V	0.070	1.87
180	18	M	100KHz, 1.0V	0.081	1.73
220	22	M	100KHz, 1.0V	0.088	1.60
330	33	M	100KHz, 1.0V	0.120	1.26
470	47	M	100KHz, 1.0V	0.170	1.10
560	56	M	100KHz, 1.0V	0.199	1.01
680	68	M	100KHz, 1.0V	0.223	0.91
820	82	M	100KHz, 1.0V	0.252	0.85
101	100	M	100KHz, 1.0V	0.344	0.74
121	120	M	100KHz, 1.0V	0.396	0.69
181	180	M	100KHz, 1.0V	0.621	0.56
221	220	M	100KHz, 1.0V	0.721	0.53
331	330	M	100KHz, 1.0V	1.100	0.42
471	470	M	100KHz, 1.0V	1.526	0.35
561	560	M	100KHz, 1.0V	1.904	0.32

### 10F9

Codes	L (μH)	Tolerance	Test Condition	DCR (Ω) max.	IDC (A) max.
100	10	M	100KHz, 1.0V	0.060	2.60
120	12	M	100KHz, 1.0V	0.070	2.45
150	15	M	100KHz, 1.0V	0.080	2.27
220	22	M	100KHz, 1.0V	0.100	1.95
330	33	M	100KHz, 1.0V	0.120	1.50
390	39	M	100KHz, 1.0V	0.140	1.37
470	47	M	100KHz, 1.0V	0.170	1.28
560	56	M	100KHz, 1.0V	0.190	1.17
680	68	M	100KHz, 1.0V	0.220	1.11
820	82	M	100KHz, 1.0V	0.250	1.00
101	100	M	100KHz, 1.0V	0.350	0.97
121	120	M	100KHz, 1.0V	0.400	0.89
151	150	M	100KHz, 1.0V	0.470	0.78
221	220	M	100KHz, 1.0V	0.730	0.66
271	270	M	100KHz, 1.0V	0.970	0.57
331	330	M	100KHz, 1.0V	1.150	0.52
471	470	M	100KHz, 1.0V	1.480	0.42
561	560	M	100KHz, 1.0V	1.900	0.33
821	820	M	100KHz, 1.0V	2.550	0.24

# LMax SMD Shielded Power Inductor

## LMXS Series – Shielded Style B

### FEATURES

- Directly connected electrode on ferrite core
- Excellent property with high saturation for surface mounting

### APPLICATIONS

- OA Equipment
- Notebook PCs
- LCD Monitor
- Portable Terminal Equipment
- DC/DC Converters, etc.
- Power Supply for VTR

### DIMENSIONS

### CHARACTERISTICS

- Rated DC Current: The current when the inductance becomes 30% lower than its initial value.
- Operating temperature: -40 ~ 85°C

### INDUCTANCE AND RATED CURRENT RANGES

- |        |               |               |
|--------|---------------|---------------|
| • 04B4 | 0.47 ~ 2200μH | 1.84 ~ 0.035A |
| • 04C4 | 1.0 ~ 6800μH  | 1.90 ~ 0.017A |
| • 04A4 | 1.0 ~ 100μH   | 1.50 ~ 0.100A |
| • 0505 | 0.47 ~ 820μH  | 2.33 ~ 0.030A |
| • 05C5 | 0.47 ~ 2500μH | 4.82 ~ 0.045A |
| • 0606 | 1.0 ~ 3300μH  | 4.70 ~ 0.026A |
- Electrical specifications at 25°C

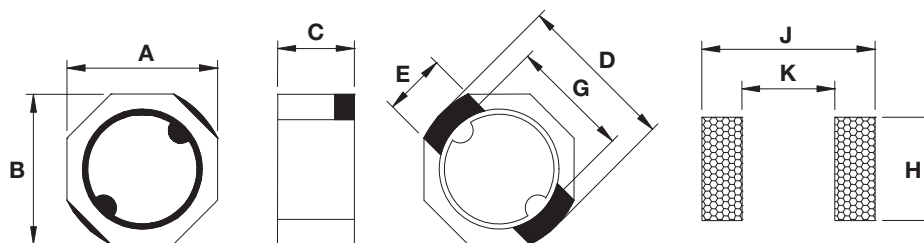

mm (inches)

Type	A	B	C max.	D	E	G	H	K	J
04B4	3.85 ± 0.30 (0.152 ± 0.012)	3.85 ± 0.30 (0.152 ± 0.012)	2.00 (0.079)	3.9 ± 0.20 (0.154 ± 0.008)	1.60 (0.063)	3.20 (0.126)	1.90 (0.075)	3.00 (0.118)	4.55 (0.179)
04C4	3.85 ± 0.30 (0.152 ± 0.012)	3.85 ± 0.30 (0.152 ± 0.012)	3.00 (0.118)	3.9 ± 0.20 (0.154 ± 0.008)	1.60 (0.063)	3.20 (0.126)	1.90 (0.075)	3.00 (0.118)	4.55 (0.179)
04A4	3.85 ± 0.30 (0.152 ± 0.012)	3.85 ± 0.30 (0.152 ± 0.012)	1.50 (0.059)	4.80 max. (0.189 max.)	1.60 (0.063)	3.00 (0.118)	2.00 (0.079)	2.60 (0.102)	5.20 (0.205)
0505	5.30 max. (0.207 max.)	5.30 max. (0.207 max.)	2.00 (0.079)	5.7 ± 0.40 (0.224 ± 0.016)	1.60 (0.063)	4.20 (0.165)	1.90 (0.075)	3.90 (0.154)	5.70 (0.224)
05C5	5.30 max. (0.207 max.)	5.30 max. (0.207 max.)	3.00 (0.118)	5.7 ± 0.40 (0.224 ± 0.016)	1.60 (0.063)	4.20 (0.165)	1.90 (0.075)	3.90 (0.154)	5.70 (0.224)
0606	5.90 ± 0.20 (0.232 ± 0.008)	5.90 ± 0.20 (0.232 ± 0.008)	3.00 (0.118)	6.4 ± 0.30 (0.252 ± 0.012)	2.40 (0.094)	4.70 (0.185)	2.70 (0.106)	4.40 (0.173)	6.50 (0.256)

### HOW TO ORDER

<b>LM</b>	<b>XS</b>	<b>0505</b>	<b>M</b>	<b>R04</b>	<b>B</b>	<b>T</b>	<b>A</b>	<b>S</b>
<b>Family</b>	<b>Series</b>	<b>Size</b>	<b>Tolerance</b>	<b>Inductance</b>	<b>Style</b>	<b>Termination</b>	<b>Special</b>	<b>Packaging</b>
LM = Power Inductor	XS = Shielded	0505 = 5x5xh 05A5 = 5x5xA(h) (h = see catalog)	M = ±20% N = ±30% P = ±40%	R04 = 0.039μH R39 = 0.390μH 3R9 = 3.900μH 390 = 39.00μH 391 = 390.0μH 392 = 3900μH		T = Sn Plate	A = Standard	S = 13" Reel

# LMax SMD Power Inductor

## LMXS Series – Shielded Style B



### ELECTRICAL CHARACTERISTICS

#### 04B4/04C4

Codes	L (µH)	Tolerance	Test	DCR (Ω) max.		I sat (A) max*	
			Condition	04B4	04C4	04B4	04C4
R47	0.47	N	100 KHz, 0.25V	0.017	–	1.84	–
1R0	1.0	N	100 KHz, 0.25V	0.030	0.009	1.80	1.90
1R2	1.2	N	100 KHz, 0.25V	0.043	0.010	1.70	1.75
1R5	1.5	N	100 KHz, 0.25V	0.052	0.013	1.60	1.45
1R8	1.8	N	100 KHz, 0.25V	0.056	–	1.55	–
2R0	2.0	N	100 KHz, 0.25V	0.057	0.016	1.51	1.25
2R2	2.2	N	100 KHz, 0.25V	0.058	0.025	1.50	1.15
2R4	2.4	N	100 KHz, 0.25V	0.059	–	1.41	–
2R5	2.5	N	100 KHz, 0.25V	0.059	0.018	1.40	1.05
2R7	2.7	N	100 KHz, 0.25V	0.060	0.020	1.35	1.00
3R3	3.3	N	100 KHz, 0.25V	0.064	0.030	1.30	0.96
3R5	3.5	N	100 KHz, 0.25V	0.127	0.025	1.30	0.95
3R9	3.9	N	100 KHz, 0.25V	–	0.033	–	0.87
4R7	4.7	N	100 KHz, 0.25V	0.146	0.039	1.10	0.78
5R6	5.6	N	100 KHz, 0.25V	0.176	0.044	0.95	0.74
6R2	6.2	N	100 KHz, 0.25V	0.220	–	0.91	–
6R8	6.8	N	100 KHz, 0.25V	0.238	0.051	0.90	0.68
8R2	8.2	N	100 KHz, 0.25V	0.272	0.065	0.80	0.57
100	10	M	1KHz, 0.25V	0.299	0.092	0.70	0.43
120	12	M	1KHz, 0.25V	–	0.100	–	0.38
150	15	M	1KHz, 0.25V	0.472	0.113	0.61	0.33
180	18	M	1KHz, 0.25V	0.552	0.125	0.58	0.30
220	22	M	1KHz, 0.25V	0.592	0.146	0.52	0.28
270	27	M	1KHz, 0.25V	0.630	0.176	0.44	0.26
330	33	M	1KHz, 0.25V	1.075	0.214	0.43	0.23
390	39	M	1KHz, 0.25V	1.269	0.225	0.37	0.21
470	47	M	1KHz, 0.25V	1.309	0.304	0.34	0.19
500	50	M	1KHz, 0.25V	–	–	–	–
560	56	M	1KHz, 0.25V	1.960	0.324	0.29	0.170
680	68	M	1KHz, 0.25V	2.613	0.472	0.25	0.156
820	82	M	1KHz, 0.25V	2.950	0.539	0.20	0.142
101	100	M	1KHz, 0.25V	3.255	0.608	0.19	0.128
121	120	M	1KHz, 0.25V	3.350	0.757	0.15	0.116
151	150	M	1KHz, 0.25V	3.550	0.882	0.12	0.106
181	180	M	1KHz, 0.25V	4.000	1.130	0.10	0.095
221	220	M	1KHz, 0.25V	4.900	1.269	0.09	0.087
271	270	M	1KHz, 0.25V	–	1.570	–	0.080
331	330	M	1KHz, 0.25V	7.280	1.930	0.08	0.078
391	390	M	1KHz, 0.25V	–	2.360	–	0.073
471	470	M	1KHz, 0.25V	–	2.770	–	0.068
561	560	M	1KHz, 0.25V	–	3.520	–	0.065
681	680	M	1KHz, 0.25V	13.37	4.250	0.07	0.056
821	820	M	1KHz, 0.25V	–	4.830	–	0.050
102	1000	M	1KHz, 0.25V	19.55	6.260	0.065	0.047
122	1200	M	1KHz, 0.25V	–	7.860	–	0.043
152	1500	M	1KHz, 0.25V	36.15	9.980	0.038	0.039

\*Saturation Current: The current when the inductance becomes 30% lower than its initial value.

# LMax SMD Power Inductor

## LMXS Series – Shielded Style B



### 04A4

Codes	L (μH)	Tolerance	Test Condition	DCR (Ω) max.	I sat (A) max*
1R0	1.0	N	100KHz, 0.1V	0.058	1.50
1R2	1.2	N	100KHz, 0.1V	0.070	1.40
2R2	2.2	N	100KHz, 0.1V	0.082	1.00
3R3	3.3	N	100KHz, 0.1V	0.105	0.92
3R9	3.9	N	100KHz, 0.1V	0.120	0.80
4R7	4.7	N	100KHz, 0.1V	0.150	0.76
5R6	5.6	N	100KHz, 0.1V	0.180	0.69
6R8	6.8	N	100KHz, 0.1V	0.220	0.62
8R2	8.2	N	100KHz, 0.1V	0.240	0.56
100	10	N	100KHz, 0.1V	0.255	0.50
150	15	N	100KHz, 0.1V	0.390	0.40
220	22	M	100KHz, 0.1V	0.610	0.32
330	33	M	100KHz, 0.1V	0.920	0.28
470	47	M	100KHz, 0.1V	1.130	0.20
680	68	M	100KHz, 0.1V	1.520	0.15
101	100	M	100KHz, 0.1V	2.120	0.10

\*Saturation Current: The current when the inductance becomes 30% lower than its initial value.



# LMax SMD Power Inductor

## LMXS Series – Shielded Style B



### 0505/05C5/0606

Codes	L (µH)	Tolerance	Test Condition	DCR (Ω) max.			I sat (A) max*		
				0505	05C5	0606	0505	05C5	0606
R47	0.47	N	100KHz, 0.25V	0.015	0.010	-	2.33	4.82	-
1R0	1.0	N	100KHz, 0.25V	0.024	0.015	0.014	2.27	4.00	4.70
1R1	1.1	N	100KHz, 0.25V	-	0.020	-	-	3.87	-
1R2	1.2	N	100KHz, 0.25V	0.044	0.022	0.016	2.15	3.80	3.90
1R5	1.5	N	100KHz, 0.25V	-	-	0.018	-	-	3.52
1R8	1.8	N	100KHz, 0.25V	-	-	0.019	-	-	3.25
2R0	2.0	N	100KHz, 0.25V	0.046	0.027	0.022	1.90	2.92	2.95
2R2	2.2	N	100KHz, 0.25V	0.059	0.029	0.022	1.63	2.41	2.95
2R4	2.4	N	100KHz, 0.25V	0.062	0.034	0.024	1.50	2.36	2.75
2R7	2.7	N	100KHz, 0.25V	-	-	0.027	-	-	2.55
3R3	3.3	N	100KHz, 0.25V	0.073	0.040	0.030	1.34	1.95	2.45
3R9	3.9	N	100KHz, 0.25V	0.081	-	0.034	1.20	-	2.35
4R1	4.1	N	100KHz, 0.25V	0.087	0.045	-	1.14	1.87	-
4R7	4.7	N	100KHz, 0.25V	-	0.052	0.042	-	1.60	2.25
5R6	5.6	N	100KHz, 0.25V	-	-	0.048	-	-	2.05
6R8	6.8	N	100KHz, 0.25V	0.105	0.068	0.054	0.95	1.51	1.85
8R2	8.2	N	100KHz, 0.25V	0.139	0.084	0.058	0.90	1.38	1.65
100	10	M	1KHz, 0.25V	0.150	0.090	0.065	0.76	1.33	1.45
120	12	M	1KHz, 0.25V	-	0.120	0.082	-	1.06	1.35
150	15	M	1KHz, 0.25V	0.210	0.142	0.096	0.63	1.05	1.25
180	18	M	1KHz, 0.25V	-	0.192	0.110	-	0.90	1.15
220	22	M	1KHz, 0.25V	0.275	0.208	0.140	0.56	0.86	0.98
270	27	M	1KHz, 0.25V	0.452	0.222	0.170	0.48	0.75	0.90
330	33	M	1KHz, 0.25V	0.455	0.257	0.210	0.44	0.72	0.80
390	39	M	1KHz, 0.25V	-	0.320	0.240	-	0.64	0.72
470	47	M	1KHz, 0.25V	0.730	0.352	0.280	0.35	0.62	0.70
560	56	M	1KHz, 0.25V	-	0.459	0.340	-	0.53	0.66
680	68	M	1KHz, 0.25V	0.935	0.525	0.410	0.30	0.51	0.58
820	82	M	1KHz, 0.25V	1.300	0.770	0.490	0.27	0.48	0.52
101	100	M	1KHz, 0.25V	1.500	0.801	0.550	0.23	0.43	0.46
121	120	M	1KHz, 0.25V	1.910	0.850	0.700	0.22	0.34	0.42
151	150	M	1KHz, 0.25V	2.680	1.100	0.780	0.21	0.26	0.36
181	180	M	1KHz, 0.25V	3.040	1.190	0.960	0.20	0.24	0.34
221	220	M	1KHz, 0.25V	3.520	1.530	1.080	0.195	0.20	0.32
271	270	M	1KHz, 0.25V	4.380	-	1.360	0.193	-	0.28
331	330	M	1KHz, 0.25V	5.560	2.030	1.820	0.190	0.19	0.24
391	390	M	1KHz, 0.25V	-	3.000	2.050	-	0.16	0.22
471	470	M	1KHz, 0.25V	7.820	3.500	2.580	0.180	0.15	0.20
561	560	M	1KHz, 0.25V	-	4.080	3.160	-	0.14	0.18
681	680	M	1KHz, 0.25V	-	-	4.040	-	-	0.16
821	820	M	1KHz, 0.25V	15.00	-	4.900	0.120	-	0.14
102	1000	M	1KHz, 0.25V	-	-	6.000	-	-	0.13
122	1200	M	1KHz, 0.25V	-	8.500	7.600	-	0.070	0.12
152	1522	M	1KHz, 0.25V	-	10.00	9.440	-	0.065	0.10
182	1800	M	1KHz, 0.25V	-	13.15	11.70	-	0.062	0.098
222	2200	M	1KHz, 0.25V	-	19.00	13.40	-	0.050	0.095
252	2500	M	1KHz, 0.25V	-	20.00	-	-	0.045	-
272	2700	M	1KHz, 0.25V	-	-	17.30	-	-	0.086
332	3300	M	1KHz, 0.25V	-	-	22.10	-	-	0.078

\*Saturation Current: The current when the inductance becomes 30% lower than its initial value.

# LMax SMD Power Inductor

## LMXS Series – Shielded Style C

### FEATURES

- Directly connected electrode on ferrite core
- Available in magnetically shielded
- Low DC resistance
- Suitable for large current
- Available on tape and reel for auto surface mounting

### APPLICATIONS

- Power Supply For VTRs
- OA Equipment.
- Notebook PCs
- Portable Communication Equipment
- DC/DC Converters, etc.

### DIMENSIONS

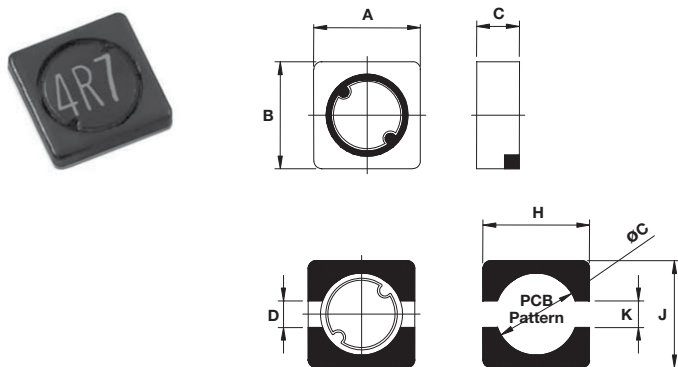

### CHARACTERISTICS

- Rated Current:  
0404/04B4/0505/05B5/05C5/0707/07B7/07D7: The DC current when the inductance becomes 30% lower than its initial value.  
04C4/101B/101D/101H: The DC current when the inductance becomes 35% lower than its initial value. (Ta=25°C)
- Operating temperature range: -40 ~ +105°C

### INDUCTANCE AND RATED CURRENT RANGES

- 0404 1.0 ~ 180µH 1.60 ~ 0.110A
- 04B4 0.47 ~ 1800µH 1.84 ~ 0.036A
- 04C4 1.5 ~ 560µH 1.90 ~ 0.090A
- 0505 1.2 ~ 1000µH 1.77 ~ 0.067A
- 05B5 1.0 ~ 820µH 2.70 ~ 0.026A
- 05C5 1.0 ~ 2500µH 4.00 ~ 0.045A
- 0707 1.0 ~ 820µH 3.28 ~ 0.100A
- 07B7 1.0 ~ 1500µH 3.52 ~ 0.095A
- 07D7 0.36 ~ 1000µH 9.24 ~ 0.180A
- Electrical specifications at 25°C



mm (inches)

Type	A	B	C max.	D	H	J	K	øC
0404	3.80 ± 0.30 (0.150 ± 0.012)	3.80 ± 0.30 (0.150 ± 0.012)	1.25 (0.049)	1.20 (0.047)	4.40 (0.173)	4.40 (0.173)	1.10 (0.043)	3.00 (0.118)
04B4	3.80 ± 0.30 (0.150 ± 0.012)	3.80 ± 0.30 (0.150 ± 0.012)	2.00 (0.079)	1.20 (0.047)	4.40 (0.173)	4.40 (0.173)	1.10 (0.043)	3.00 (0.118)
04C4	3.80 ± 0.30 (0.150 ± 0.012)	3.80 ± 0.30 (0.150 ± 0.012)	3.00 (0.118)	1.20 (0.047)	4.40 (0.173)	4.40 (0.173)	1.10 (0.043)	3.00 (0.118)
0505	5.00 ± 0.30 (0.197 ± 0.012)	5.00 ± 0.30 (0.197 ± 0.012)	1.20 (0.047)	2.00 (0.079)	5.90 (0.232)	5.90 (0.232)	1.90 (0.075)	4.20 (0.165)
05B5	5.00 ± 0.30 (0.197 ± 0.012)	5.00 ± 0.30 (0.197 ± 0.012)	2.00 (0.079)	2.00 (0.079)	5.90 (0.232)	5.90 (0.232)	1.90 (0.075)	4.20 (0.165)
05C5	5.00 ± 0.30 (0.197 ± 0.012)	5.00 ± 0.30 (0.197 ± 0.012)	3.00 (0.118)	2.00 (0.079)	5.90 (0.232)	5.90 (0.232)	1.90 (0.075)	4.20 (0.165)
0707	6.90 ± 0.30 (0.272 ± 0.012)	6.90 ± 0.30 (0.272 ± 0.012)	1.50 (0.059)	2.50 (0.098)	7.30 (0.287)	7.30 (0.287)	2.00 (0.079)	5.30 (0.209)
07B7	6.90 ± 0.30 (0.272 ± 0.012)	6.90 ± 0.30 (0.272 ± 0.012)	1.90 (0.075)	2.50 (0.098)	7.30 (0.287)	7.30 (0.287)	2.00 (0.079)	5.30 (0.209)
07D7	7.00 ± 0.40 (0.276 ± 0.016)	7.00 ± 0.40 (0.276 ± 0.016)	4.30 (0.169)	1.80 (0.071)	8.00 (0.315)	8.00 (0.315)	1.60 (0.063)	6.00 (0.236)

# LMax SMD Power Inductor

## LMXS Series – Shielded Style C

### HOW TO ORDER

<b>LM</b>	<b>XS</b>	<b>0707</b>	<b>M</b>	<b>R04</b>	<b>C</b>	<b>T</b>	<b>A</b>	<b>S</b>
Family	Series	Size	Tolerance	Inductance	Style	Termination	Special	Packaging
LM = Power Inductor	XS = Shielded	0707 = 7x7xh 07D7 = 7x7xD(h) (h = see catalog)	M = ±20% N = ±30%	R04 = 0.039µH R39 = 0.390µH 3R9 = 3.900µH 390 = 39.00µH 391 = 390.0µH 392 = 3900µH		T = Sn Plate	A = Standard	S = 13" Reel

### ELECTRICAL CHARACTERISTICS

#### 0404/04B4/04C4

Codes	L (µH)	Tolerance	Test Condition	DCR (Ω) max.			I sat (A) max*		
				0404	04B4	04C4	0404	04B4	04C4
R47	0.47	N	100KHz, 0.25V	-	0.017	-	-	1.840	-
1R0	1.0	M, N	100KHz, 0.25V	0.060	0.030	-	1.600	1.800	-
1R2	1.2	M, N	100KHz, 0.25V	0.065	0.043	-	1.400	1.700	-
1R5	1.5	M, N	100KHz, 0.25V	0.077	0.052	0.015	1.240	1.600	1.900
1R8	1.8	M, N	100KHz, 0.25V	0.093	-	0.018	1.220	-	1.760
2R2	2.2	M, N	100KHz, 0.25V	0.125	0.058	0.020	1.200	1.500	1.670
2R4	2.4	M, N	100KHz, 0.25V	0.139	-	0.022	0.980	-	1.650
2R5	2.5	M, N	100KHz, 0.25V	-	0.059	-	-	1.400	-
2R7	2.7	M, N	100KHz, 0.25V	-	0.059	0.028	-	1.400	1.450
3R3	3.3	M, N	100KHz, 0.25V	0.187	0.064	0.032	0.890	1.300	1.440
3R5	3.5	M, N	100KHz, 0.25V	0.210	0.127	-	0.850	1.300	-
3R6	3.6	M, N	100KHz, 0.25V	-	-	0.035	-	-	1.430
3R9	3.9	M, N	100KHz, 0.25V	0.220	0.135	0.037	0.780	1.120	1.320
4R3	4.3	M, N	100KHz, 0.25V	-	-	0.043	-	-	1.000
4R7	4.7	M, N	100KHz, 0.25V	0.240	0.146	0.045	0.710	1.100	0.970
5R1	5.1	M, N	100KHz, 0.25V	-	-	0.046	-	-	0.940
5R6	5.6	M, N	100KHz, 0.25V	0.320	0.176	-	0.620	0.950	-
6R2	6.2	M, N	100KHz, 0.25V	-	0.220	-	-	0.910	-
6R8	6.8	M, N	100KHz, 0.25V	0.350	0.238	0.065	0.570	0.900	0.870
7R5	7.5	M, N	100KHz, 0.25V	-	-	0.079	-	-	0.820
8R2	8.2	M, N	100KHz, 0.25V	0.470	0.272	0.071	0.520	0.800	0.770
100	10	M	1KHz, 0.25V	0.570	0.299	0.105	0.470	0.700	0.700
120	12	M	1KHz, 0.25V	0.750	-	0.119	0.430	-	0.670
150	15	M	1KHz, 0.25V	0.810	0.472	0.140	0.380	0.610	0.540
180	18	M	1KHz, 0.25V	1.060	-	0.175	0.350	-	0.500
220	22	M	1KHz, 0.25V	1.150	0.592	0.201	0.320	0.520	0.480
270	27	M	1KHz, 0.25V	1.670	0.630	0.227	0.290	0.440	0.400
330	33	M	1KHz, 0.25V	1.840	1.075	0.287	0.280	0.430	0.350
390	39	M	1KHz, 0.25V	2.310	-	0.341	0.250	-	0.330
470	47	M	1KHz, 0.25V	2.630	1.309	0.430	0.220	0.340	0.320
560	56	M	1KHz, 0.25V	2.860	-	0.471	0.200	-	0.300
680	68	M	1KHz, 0.25V	3.940	2.613	0.532	0.180	0.250	0.270
820	82	M	1KHz, 0.25V	4.900	2.950	0.675	0.160	0.200	0.230
101	100	M	1KHz, 0.25V	5.740	3.255	0.850	0.140	0.190	0.210
121	120	M	1KHz, 0.25V	7.310	-	1.110	0.130	-	0.200
151	150	M	1KHz, 0.25V	9.080	3.550	1.230	0.120	0.120	0.170
181	180	M	1KHz, 0.25V	9.500	-	1.560	0.110	-	0.150
221	220	M	1KHz, 0.25V	-	4.900	1.800	-	0.090	0.140
271	270	M	1KHz, 0.25V	-	-	2.200	-	-	0.130
331	330	M	1KHz, 0.25V	-	7.280	2.640	-	0.080	0.120
471	470	M	1KHz, 0.25V	-	-	3.820	-	-	0.100
561	560	M	1KHz, 0.25V	-	-	4.620	-	-	0.090
681	680	M	1KHz, 0.25V	-	13.370	-	-	0.070	-
102	1000	M	1KHz, 0.25V	-	19.550	-	-	0.065	-
152	1500	M	1KHz, 0.25V	-	36.150	-	-	0.038	-
182	1800	M	1KHz, 0.25V	-	57.620	-	-	0.036	-

\*Saturation Current (0404/04B4): The DC current when the inductance becomes 30% lower than its initial value. (Ta=25°C)

\*Saturation Current (04C4): The DC current when the inductance becomes 35% lower than its initial value. (Ta=25°C)

# LMax SMD Power Inductor

## LMXS Series – Shielded Style C



### 0505/05B5/05C5

Codes	L (μH)	Tolerance	Test Condition	DCR (Ω) max.			I sat (A) max*		
				0505	05B5	05C5	0505	05B5	05C5
1R0	1.0	M, N	100KHz, 0.25V	–	0.030	0.015	–	2.700	4.000
1R1	1.1	M, N	100KHz, 0.25V	–	–	0.020	–	–	3.870
1R2	1.2	M, N	100KHz, 0.25V	0.050	0.044	0.022	1.770	2.150	3.800
1R5	1.5	M, N	100KHz, 0.25V	0.069	–	–	1.710	–	–
2R0	2.0	M, N	100KHz, 0.25V	0.100	0.046	0.027	1.440	1.900	2.920
2R2	2.2	M, N	100KHz, 0.25V	0.110	0.059	0.029	1.400	1.630	2.410
3R3	3.3	M, N	100KHz, 0.25V	0.140	0.062	0.034	1.140	1.500	2.360
3R5	3.5	M, N	100KHz, 0.25V	0.150	0.073	–	1.100	1.340	–
4R1	4.1	M, N	100KHz, 0.25V	–	0.081	–	–	1.200	–
4R7	4.7	M, N	100KHz, 0.25V	0.190	0.087	0.045	0.950	1.140	1.870
5R6	5.6	M, N	100KHz, 0.25V	0.193	0.093	0.052	0.900	1.000	1.600
6R2	6.2	M, N	100KHz, 0.25V	0.200	–	–	0.840	–	–
6R8	6.8	M, N	100KHz, 0.25V	0.200	0.105	0.068	0.800	0.950	1.510
8R2	8.2	M, N	100KHz, 0.25V	0.300	0.139	0.084	0.750	0.900	1.380
100	10	M	1KHz, 0.25V	0.350	0.150	0.090	0.660	0.760	1.330
120	12	M	1KHz, 0.25V	0.430	0.170	–	0.620	0.660	–
150	15	M	1KHz, 0.25V	0.440	0.210	0.142	0.590	0.630	1.050
180	18	M	1KHz, 0.25V	0.750	–	–	0.570	–	–
220	22	M	1KHz, 0.25V	0.820	0.275	0.208	0.560	0.560	0.860
270	27	M	1KHz, 0.25V	–	–	0.222	–	–	0.750
330	33	M	1KHz, 0.25V	1.160	0.455	0.257	0.430	0.440	0.720
390	39	M	1KHz, 0.25V	–	0.540	–	–	0.380	–
470	47	M	1KHz, 0.25V	1.590	0.730	0.352	0.340	0.350	0.620
560	56	M	1KHz, 0.25V	–	0.800	–	–	0.320	–
680	68	M	1KHz, 0.25V	2.140	0.935	0.525	0.290	0.300	0.510
820	82	M	1KHz, 0.25V	2.720	–	–	0.250	–	–
101	100	M	1KHz, 0.25V	3.550	1.500	0.801	0.220	0.230	0.430
121	120	M	1KHz, 0.25V	4.890	1.910	0.850	0.200	0.220	0.340
151	150	M	1KHz, 0.25V	5.200	2.680	1.100	0.190	0.210	0.260
181	180	M	1KHz, 0.25V	7.550	3.045	1.190	0.170	0.200	0.240
221	220	M	1KHz, 0.25V	7.760	3.520	1.530	0.150	0.195	0.200
271	270	M	1KHz, 0.25V	10.13	4.380	–	0.145	0.193	–
331	330	M	1KHz, 0.25V	11.23	5.560	2.030	0.140	0.190	0.190
391	390	M	1KHz, 0.25V	–	–	3.000	–	–	0.160
471	470	M	1KHz, 0.25V	16.86	7.820	3.500	0.098	0.180	0.150
561	560	M	1KHz, 0.25V	22.78	9.790	4.450	0.097	0.170	0.140
681	680	M	1KHz, 0.25V	24.87	–	–	0.085	–	–
821	820	M	1KHz, 0.25V	28.09	15.00	–	0.077	0.120	–
102	1000	M	1KHz, 0.25V	45.07	–	–	0.067	–	–
122	1200	M	1KHz, 0.25V	–	–	8.500	–	–	0.070
152	1500	M	1KHz, 0.25V	–	–	10.00	–	–	0.065
182	1800	M	1KHz, 0.25V	–	–	13.15	–	–	0.062
222	2200	M	1KHz, 0.25V	–	–	19.00	–	–	0.050
252	2500	M	1KHz, 0.25V	–	–	20.00	–	–	0.045

\*Saturation Current (0505/05B5/05C5): The DC current when the inductance becomes 30% lower than its initial value.

# LMax SMD Power Inductor

## LMXS Series – Shielded Style C



### 0707/07B7/07D7

Codes	L (μH)	Tolerance	Test Condition	DCR (Ω) max.			I sat (A) max*		
				0707	07B7	07D7	0707	07B7	07D7
R36	0.36	N	100KHz, 0.25V	-	-	0.005	-	-	9.240
R56	0.56	N	100KHz, 0.25V	-	-	0.006	-	-	8.500
R80	0.80	N	100KHz, 0.25V	-	-	0.009	-	-	5.800
1R0	1.0	M, N	100KHz, 0.25V	0.050	0.035	0.040	3.280	3.520	2.100
1R2	1.2	M, N	100KHz, 0.25V	-	-	0.040	-	-	2.100
1R5	1.5	M, N	100KHz, 0.25V	0.067	-	0.040	2.530	-	2.100
1R8	1.8	M, N	100KHz, 0.25V	-	0.052	0.040	-	3.050	2.090
2R0	2.0	M, N	100KHz, 0.25V	0.085	-	-	2.060	-	-
2R2	2.2	M, N	100KHz, 0.25V	-	0.071	0.0410	-	2.500	2.080
2R5	2.5	M, N	100KHz, 0.25V	-	-	0.0410	-	-	2.080
2R7	2.7	M, N	100KHz, 0.25V	0.110	-	-	1.870	-	-
3R0	3.0	M, N	100KHz, 0.25V	-	0.086	-	-	2.150	-
3R3	3.3	M, N	100KHz, 0.25V	0.130	-	0.0410	1.580	-	2.070
3R9	3.9	M, N	100KHz, 0.25V	0.160	0.110	-	1.460	2.010	-
4R3	4.3	M, N	100KHz, 0.25V	-	-	0.041	-	-	2.060
4R7	4.7	M, N	100KHz, 0.25V	0.200	0.130	0.042	1.300	1.950	2.050
5R6	5.6	M, N	100KHz, 0.25V	0.230	0.150	0.043	1.220	1.820	2.040
6R8	6.8	M, N	100KHz, 0.25V	0.280	0.170	0.044	1.160	1.670	2.040
8R2	8.2	M, N	100KHz, 0.25V	0.310	0.190	-	1.130	1.520	-
100	10	M	1KHz, 0.25V	0.330	0.240	0.049	1.030	1.390	2.000
120	12	M	1KHz, 0.25V	0.460	0.290	0.058	0.870	1.220	1.900
150	15	M	1KHz, 0.25V	0.530	0.380	0.081	0.800	1.090	1.600
180	18	M	1KHz, 0.25V	0.620	0.440	0.091	0.730	1.030	1.480
220	22	M	1KHz, 0.25V	0.700	0.490	0.110	0.710	0.950	1.320
270	27	M	1KHz, 0.25V	0.910	0.640	0.150	0.650	0.840	1.260
330	33	M	1KHz, 0.25V	1.150	0.740	0.170	0.570	0.800	1.100
390	39	M	1KHz, 0.25V	1.380	0.910	0.230	0.500	0.750	1.050
470	47	M	1KHz, 0.25V	1.540	1.020	0.260	0.480	0.690	1.000
560	56	M	1KHz, 0.25V	1.860	1.260	0.350	0.450	0.630	0.850
680	68	M	1KHz, 0.25V	2.320	1.570	0.380	0.410	0.560	0.780
820	82	M	1KHz, 0.25V	2.540	1.890	0.430	0.370	0.510	0.740
101	100	M	1KHz, 0.25V	3.20	2.12	0.61	0.32	0.47	0.70
121	120	M	1KHz, 0.25V	4.24	2.55	0.66	0.29	0.42	0.60
151	150	M	1KHz, 0.25V	4.77	3.37	0.88	0.27	0.37	0.52
181	180	M	1KHz, 0.25V	6.04	3.73	0.98	0.24	0.32	0.46
221	220	M	1KHz, 0.25V	7.95	4.54	1.17	0.22	0.29	0.40
271	270	M	1KHz, 0.25V	10.51	5.97	1.64	0.19	0.25	0.36
331	330	M	1KHz, 0.25V	11.63	7.74	1.86	0.18	0.23	0.32
391	390	M	1KHz, 0.25V	12.97	9.92	2.85	0.16	0.21	0.28
471	470	M	1KHz, 0.25V	16.87	12.95	3.01	0.15	0.18	0.26
561	560	M	1KHz, 0.25V	22.3	14.36	3.62	0.13	0.16	0.24
681	680	M	1KHz, 0.25V	25.11	18.52	4.63	0.12	0.14	0.22
821	820	M	1KHz, 0.25V	28.41	20.23	5.20	0.10	0.13	0.20
102	1000	M	1KHz, 0.25V	-	28.25	6.00	-	0.11	0.18
122	1200	M	1KHz, 0.25V	-	31.85	-	-	0.10	-
152	1500	M	1KHz, 0.25V	-	36.72	-	-	0.095	-

\*Saturation Current (0707/07B7/07D7): The DC current when the inductance becomes 30% lower than its initial value.

# LMax SMD Power Inductor

## LMXS Series – Shielded Style D

### FEATURES

- Magnetically shielded against radiation
- 0704 can help achieve longer battery life significantly in handheld communication devices.
- 1309 / 1915 designed for the higher current requirements of portable computers.
- 0704 has ceramic base with gold-plating
- 1309 / 1915 has LCP plastic base

### APPLICATIONS

- Portable Telephones
- Personal Computers
- Other Various Electronic Appliances
- DC/DC Converters, etc.

### DIMENSIONS

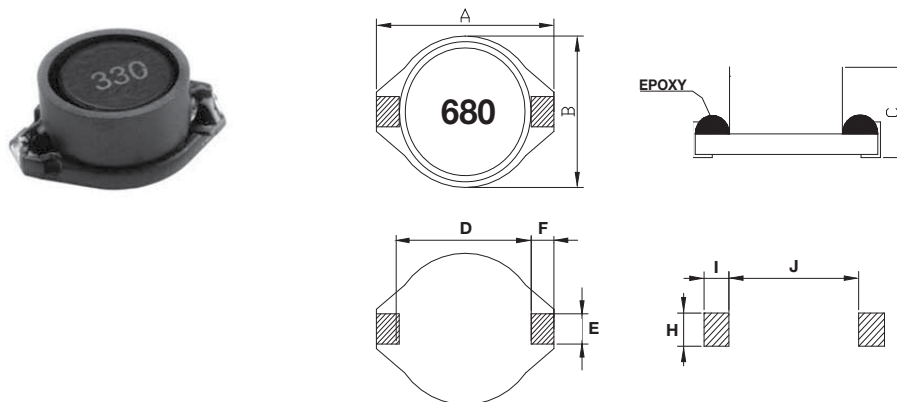

### CHARACTERISTICS

- Saturation Rated Current (IDC): The DC current when the inductance becomes 10% lower than its initial value. (Ta=25°C)
- Temperature Rise Current (I rms): The actual current when temperature of coil becomes Δ40°C. (Ta=25°C)
- Operating temperature range: -40 ~ 85°C

### INDUCTANCE AND RATED CURRENT RANGES

- 0704 1.0 ~ 10000μH 3.0 ~ 0.02A
- 1309 1.0 ~ 1000μH 5.0 ~ 0.17A
- 1915 10 ~ 1000μH 3.9 ~ 0.53A
- Electrical specifications at 25°C



mm (inches)

Type	A max.	B max.	C max.	D	E	F	H	I	J
0704	6.60 (0.260)	4.45 (0.175)	2.92 (0.115)	4.32 (0.170)	1.27 (0.050)	1.02 (0.040)	3.56 (0.140)	1.40 (0.055)	4.06 (0.160)
1309	12.95 (0.510)	9.40 (0.370)	5.21 (0.205)	7.62 (0.300)	2.54 (0.100)	2.54 (0.100)	2.79 (0.110)	2.92 (0.115)	7.37 (0.290)
1915	18.54 (0.730)	15.24 (0.600)	7.62 (0.300)	12.70 (0.500)	2.54 (0.100)	2.54 (0.100)	2.79 (0.110)	2.92 (0.115)	12.45 (0.490)

### HOW TO ORDER

<b>LM</b>	<b>XS</b>	<b>0704</b>	<b>M</b>	<b>R04</b>	<b>D</b>	<b>T</b>	<b>A</b>	<b>S</b>
<b>Family</b>	<b>Series</b>	<b>Size</b>	<b>Tolerance</b>	<b>Inductance</b>	<b>Style</b>	<b>Termination</b>	<b>Special</b>	<b>Packaging</b>
LM = Power Inductor	XS = Shielded	0704 = 7x4xh 1309 = 13x9xh (h = see catalog)	M = ±20%	R04 = 0.039μH R39 = 0.390μH 3R9 = 3.900μH 390 = 39.00μH 391 = 390.0μH 392 = 3900μH		T = Sn Plate	A = Standard	S = 13" Reel

# LMax SMD Power Inductor

## LMXS Series – Shielded Style D



### ELECTRICAL CHARACTERISTICS

#### 0704

Codes	L ( $\mu$ H)	Tolerance	Test Condition		DCR ( $\Omega$ ) max.	SRF ref (MHz)	Q min.	I rms (A) max.
			L	Q				
1R0	1.0	M	100KHz, 0.1V	200KHz, 0.1V	0.040	250	30	3.00
1R5	1.5	M	100KHz, 0.1V	200KHz, 0.1V	0.045	125	30	2.30
2R2	2.2	M	100KHz, 0.1V	200KHz, 0.1V	0.050	120	40	1.80
3R3	3.3	M	100KHz, 0.1V	200KHz, 0.1V	0.055	120	40	1.60
4R7	4.7	M	100KHz, 0.1V	200KHz, 0.1V	0.060	105	40	1.40
6R8	6.8	M	100KHz, 0.1V	200KHz, 0.1V	0.065	50	40	1.20
100	10	M	100KHz, 0.1V	200KHz, 0.1V	0.075	38	40	1.00
150	15	M	100KHz, 0.1V	100KHz, 0.1V	0.090	33	40	0.80
220	22	M	100KHz, 0.1V	100KHz, 0.1V	0.11	25	40	0.70
330	33	M	100KHz, 0.1V	100KHz, 0.1V	0.19	20	40	0.60
470	47	M	100KHz, 0.1V	100KHz, 0.1V	0.23	20	40	0.50
680	68	M	100KHz, 0.1V	100KHz, 0.1V	0.29	15	40	0.40
101	100	M	100KHz, 0.1V	100KHz, 0.1V	0.48	10	40	0.30
151	150	M	100KHz, 0.1V	100KHz, 0.1V	0.59	9	40	0.26
221	220	M	100KHz, 0.1V	100KHz, 0.1V	0.90	6	40	0.22
331	330	M	100KHz, 0.1V	100KHz, 0.1V	1.40	5	40	0.20
471	470	M	100KHz, 0.1V	100KHz, 0.1V	1.80	4	40	0.19
681	680	M	100KHz, 0.1V	100KHz, 0.1V	2.20	3	40	0.18
102	1000	M	100KHz, 0.1V	100KHz, 0.1V	3.40	2	40	0.15
152	1500	M	100KHz, 0.1V	100KHz, 0.1V	4.20	2	50	0.12
222	2200	M	100KHz, 0.1V	100KHz, 0.1V	8.50	2	50	0.10
332	3300	M	100KHz, 0.1V	100KHz, 0.1V	11.0	1	50	0.08
472	4700	M	100KHz, 0.1V	100KHz, 0.1V	13.9	1	50	0.06
682	6800	M	100KHz, 0.1V	100KHz, 0.1V	25.0	1	50	0.04
103	10000	M	100KHz, 0.1V	100KHz, 0.1V	32.8	0.8	50	0.02

#### 1309

Codes	L ( $\mu$ H)	Tolerance	Test Condition	DCR ( $\Omega$ ) max.	SRF ref (MHz)	IDC (A) max	I rms (A) max.
1R0	1.0	M	100KHz, 0.1V	0.021	140	5.6	5.0
1R5	1.5	M	100KHz, 0.1V	0.022	120	5.2	4.5
2R2	2.2	M	100KHz, 0.1V	0.032	80	5.0	3.8
3R3	3.3	M	100KHz, 0.1V	0.039	70	3.9	3.3
4R7	4.7	M	100KHz, 0.1V	0.054	40	3.2	2.7
6R8	6.8	M	100KHz, 0.1V	0.075	38	2.8	2.2
100	10	M	100KHz, 0.1V	0.101	35	2.4	2.0
150	15	M	100KHz, 0.1V	0.150	25	2.0	1.5
220	22	M	100KHz, 0.1V	0.207	19	1.6	1.3
330	33	M	100KHz, 0.1V	0.334	15	1.4	1.1
470	47	M	100KHz, 0.1V	0.472	13	1.0	0.8
680	68	M	100KHz, 0.1V	0.660	10	0.9	0.7
101	100	M	100KHz, 0.1V	1.110	7	0.8	0.6
151	150	M	100KHz, 0.1V	1.550	6	0.6	0.5
221	220	M	100KHz, 0.1V	2.000	5	0.5	0.37
102	1000	M	100KHz, 0.1V	8.300	2	0.32	0.17

# LMax SMD Power Inductor

## LMXS Series – Shielded Style D



1915

Codes	L ( $\mu$ H)	Tolerance	Test Condition	DCR ( $\Omega$ ) max.	SRF ref (MHz)	IDC (A) max.	I rms (A) max.
100	10	M	100KHz, 0.1V	0.040	30	8.0	3.9
150	15	M	100KHz, 0.1V	0.048	20	7.00	3.4
220	22	M	100KHz, 0.1V	0.059	18	6.00	3.1
330	33	M	100KHz, 0.1V	0.075	14	5.00	2.8
470	47	M	100KHz, 0.1V	0.097	10	4.00	2.4
680	68	M	100KHz, 0.1V	0.138	9.0	3.00	2.0
101	100	M	100KHz, 0.1V	0.207	7.0	2.40	1.7
151	150	M	100KHz, 0.1V	0.293	6.0	2.10	1.3
221	220	M	100KHz, 0.1V	0.470	5.0	1.90	1.1
331	330	M	100KHz, 0.1V	0.780	4.0	1.10	0.86
471	470	M	100KHz, 0.1V	1.080	3.0	1.10	0.73
681	680	M	100KHz, 0.1V	1.400	2.5	0.96	0.64
102	1000	M	100KHz, 0.1V	2.010	2.0	0.80	0.53



# LMax SMD Power Inductor

## LMXS Series – Shielded Style F

### FEATURES

- Magnetically Shielded Construction
- Large Current
- Low DCR

### APPLICATIONS

- Telephones
- PCs
- Notebooks
- Hard Disk Drives
- Peripherals

### CHARACTERISTICS

- Rated Current (IDC): The DC current that will cause an approximate  $\Delta T$  of 40°C. ( $T_a=25^\circ\text{C}$ )
- Operating temperature range:  $-40^\circ\text{C} \sim +125^\circ\text{C}$

### INDUCTANCE AND RATED CURRENT RANGES

- 0606 4.7 $\mu\text{H}$  ~ 100.0 $\mu\text{H}$  1.50 ~ 0.33A
- 06C6 4.7 $\mu\text{H}$  ~ 100.0 $\mu\text{H}$  1.60 ~ 0.42A
- 0707 3.3 $\mu\text{H}$  ~ 47.0 $\mu\text{H}$  1.60 ~ 0.54A
- 07C7 3.3 $\mu\text{H}$  ~ 1000.0 $\mu\text{H}$  1.90 ~ 0.13A
- 07E7 3.3 $\mu\text{H}$  ~ 1000.0 $\mu\text{H}$  2.30 ~ 0.14A
- 1010 10.0 $\mu\text{H}$  ~ 1500.0 $\mu\text{H}$  2.50 ~ 0.22A
- 1313 6.0 $\mu\text{H}$  ~ 1500.0 $\mu\text{H}$  3.60 ~ 0.29A
- 131H 2.0 $\mu\text{H}$  ~ 220.0 $\mu\text{H}$  6.20 ~ 1.00A
- 131J 1.2 $\mu\text{H}$  ~ 220.0 $\mu\text{H}$  8.20 ~ 1.30A
- Electrical specifications at 25°C



### DIMENSIONS

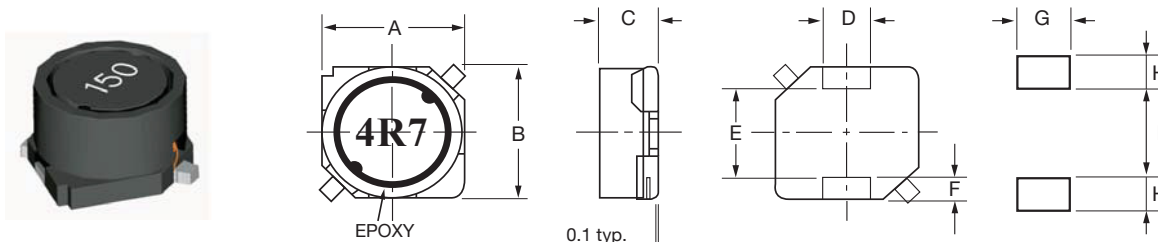

mm (inches)

Type	A	B	C	D	E	F	G	H	I
0606	6.00 ± 0.20 (0.236 ± 0.008)	6.00 ± 0.20 (0.236 ± 0.008)	2.50 ± 0.20 (0.099 ± 0.008)	2.00 ± 0.10 (0.079 ± 0.004)	3.00 typ (0.118 typ)	1.50 typ (0.059 typ)	2.20 (0.087)	2.00 (0.079)	2.60 (0.103)
06C6	6.00 ± 0.20 (0.236 ± 0.008)	6.00 ± 0.20 (0.236 ± 0.008)	2.80 ± 0.20 (0.110 ± 0.008)	2.00 ± 0.10 (0.079 ± 0.004)	3.00 typ (0.118 typ)	1.50 typ (0.059 typ)	2.20 (0.087)	2.00 (0.079)	2.60 (0.103)
0707	7.00 ± 0.20 (0.276 ± 0.008)	7.00 ± 0.20 (0.276 ± 0.008)	2.80 ± 0.20 (0.110 ± 0.008)	2.00 ± 0.10 (0.079 ± 0.004)	4.00 typ (0.193 typ)	1.50 typ (0.059 typ)	2.20 (0.087)	2.00 (0.079)	3.60 (0.103)
07C7	7.00 ± 0.20 (0.276 ± 0.008)	7.00 ± 0.20 (0.276 ± 0.008)	3.20 ± 0.20 (0.126 ± 0.008)	2.00 ± 0.10 (0.079 ± 0.004)	4.00 typ (0.193 typ)	1.50 typ (0.059 typ)	2.20 (0.087)	2.00 (0.079)	3.60 (0.142)
07E7	7.00 ± 0.20 (0.276 ± 0.008)	7.00 ± 0.20 (0.276 ± 0.008)	4.50 ± 0.30 (0.177 ± 0.012)	2.00 ± 0.10 (0.079 ± 0.004)	4.00 typ (0.193 typ)	1.50 typ (0.059 typ)	2.20 (0.087)	2.00 (0.079)	3.60 (0.142)
1010	10.1 ± 0.30 (0.398 ± 0.012)	10.1 ± 0.30 (0.398 ± 0.012)	4.50 ± 0.30 (0.177 ± 0.012)	3.00 ± 0.10 (0.118 ± 0.004)	6.00 ± 0.20 (0.236 ± 0.008)	2.00 ± 0.15 (0.079 ± 0.006)	3.20 (0.126)	2.50 (0.099)	5.60 (0.220)
1313	12.5 ± 0.30 (0.492 ± 0.012)	12.5 ± 0.30 (0.492 ± 0.012)	5.50 ± 0.30 (0.217 ± 0.012)	3.00 ± 0.10 (0.118 ± 0.004)	8.60 ± 0.30 (0.339 ± 0.012)	2.00 ± 0.15 (0.079 ± 0.006)	3.20 (0.126)	2.50 (0.099)	8.20 (0.322)
131H	12.5 ± 0.30 (0.492 ± 0.012)	12.5 ± 0.30 (0.492 ± 0.012)	6.50 ± 0.35 (0.256 ± 0.014)	3.00 ± 0.10 (0.118 ± 0.004)	8.60 ± 0.30 (0.339 ± 0.012)	2.00 ± 0.15 (0.079 ± 0.006)	3.20 (0.126)	2.50 (0.099)	8.20 (0.322)
131J	12.5 ± 0.30 (0.492 ± 0.012)	12.5 ± 0.30 (0.492 ± 0.012)	7.50 ± 0.35 (0.295 ± 0.014)	3.00 ± 0.10 (0.118 ± 0.004)	8.60 ± 0.30 (0.339 ± 0.012)	2.00 ± 0.15 (0.079 ± 0.006)	3.20 (0.126)	2.50 (0.099)	8.20 (0.322)

### HOW TO ORDER

<b>LM</b>	<b>XS</b>	<b>0707</b>	<b>M</b>	<b>2R2</b>	<b>F</b>	<b>T</b>	<b>A</b>	<b>S</b>
<b>Family</b>	<b>Series</b>	<b>Size</b>	<b>Tolerance</b>	<b>Inductance</b>	<b>Style</b>	<b>Termination</b>	<b>Special</b>	<b>Packaging</b>
LM = Power Inductor	XS = Shielded	0707 = 7x7xh 07C7 = 7x7xC(h) (h = see catalog)	M = ±20%	2R2 = 2.20 $\mu\text{H}$ 6R0 = 68.0 $\mu\text{H}$ 152 = 1500 $\mu\text{H}$		T = Sn Plate	A = Standard	S = 13" Reel

# LMax SMD Power Inductor

## LMXS Series – Shielded Style F



### ELECTRICAL CHARACTERISTICS

#### 0606

Codes	L (μH)	Tolerance	Test Condition	DCR (Ω) max.	IDC (A) max.
4R7	4.7	M	100KHz, 1.0V	0.050	1.50
6R8	6.8	M	100KHz, 1.0V	0.080	1.30
100	10	M	100KHz, 1.0V	0.098	1.00
150	15	M	100KHz, 1.0V	0.140	0.88
220	22	M	100KHz, 1.0V	0.208	0.73
330	33	M	100KHz, 1.0V	0.310	0.59
470	47	M	100KHz, 1.0V	0.390	0.48
680	68	M	100KHz, 1.0V	0.540	0.42
101	100	M	100KHz, 1.0V	0.810	0.33

#### 06C6

Codes	L (μH)	Tolerance	Test Condition	DCR (Ω) max.	IDC (A) max.
4R7	4.7	M	100KHz, 1.0V	0.050	1.60
6R8	6.8	M	100KHz, 1.0V	0.073	1.50
100	10	M	100KHz, 1.0V	0.098	1.30
150	15	M	100KHz, 1.0V	0.128	1.00
220	22	M	100KHz, 1.0V	0.172	0.77
330	33	M	100KHz, 1.0V	0.290	0.69
470	47	M	100KHz, 1.0V	0.420	0.59
680	68	M	100KHz, 1.0V	0.533	0.50
101	100	M	100KHz, 1.0V	0.730	0.42

#### 0707

Codes	L (μH)	Tolerance	Test Condition	DCR (Ω) max.	IDC (A) max.
3R3	3.3	M	100KHz, 1.0V	0.045	1.60
4R7	4.7	M	100KHz, 1.0V	0.054	1.50
6R8	6.8	M	100KHz, 1.0V	0.071	1.30
100	10	M	100KHz, 1.0V	0.100	1.10
150	15	M	100KHz, 1.0V	0.156	0.88
220	22	M	100KHz, 1.0V	0.220	0.75
330	33	M	100KHz, 1.0V	0.290	0.65
470	47	M	100KHz, 1.0V	0.410	0.54

#### 07C7

Codes	L(μH)	Tolerance	TestCondition	DCR(Ω)max.	IDC(A)max.
3R3	3.3	M	100KHz, 1.0V	0.028	1.90
4R7	4.7	M	100KHz, 1.0V	0.044	1.70
6R8	6.8	M	100KHz, 1.0V	0.050	1.60
100	10	M	100KHz, 1.0V	0.064	1.40
150	15	M	100KHz, 1.0V	0.090	1.10
220	22	M	100KHz, 1.0V	0.132	0.96
330	33	M	100KHz, 1.0V	0.192	0.75
470	47	M	100KHz, 1.0V	0.290	0.67
680	68	M	100KHz, 1.0V	0.372	0.59
101	100	M	100KHz, 1.0V	0.540	0.45
151	150	M	100KHz, 1.0V	0.780	0.37
221	220	M	100KHz, 1.0V	1.260	0.29
331	330	M	100KHz, 1.0V	2.000	0.22
471	470	M	100KHz, 1.0V	2.460	0.20
681	680	M	100KHz, 1.0V	3.780	0.16
102	1000	M	100KHz, 1.0V	5.740	0.13

# LMax SMD Power Inductor

## LMXS Series – Shielded Style F



### 07E7

Codes	L (μH)	Tolerance	Test Condition	DCR (Ω) max.	IDC (A) max.
3R3	3.3	M	100KHz, 1.0V	0.024	2.30
4R7	4.7	M	100KHz, 1.0V	0.036	2.00
6R8	6.8	M	100KHz, 1.0V	0.047	1.70
100	10	M	100KHz, 1.0V	0.045	1.30
150	15	M	100KHz, 1.0V	0.063	1.10
220	22	M	100KHz, 1.0V	0.075	0.90
330	33	M	100KHz, 1.0V	0.120	0.82
470	47	M	100KHz, 1.0V	0.150	0.75
680	68	M	100KHz, 1.0V	0.210	0.60
101	100	M	100KHz, 1.0V	0.300	0.50
151	150	M	100KHz, 1.0V	0.410	0.40
221	220	M	100KHz, 1.0V	0.624	0.33
331	330	M	100KHz, 1.0V	0.890	0.25
471	470	M	100KHz, 1.0V	1.260	0.22
681	680	M	100KHz, 1.0V	1.780	0.20
102	1000	M	100KHz, 1.0V	2.740	0.14

### 1010

Codes	L (μH)	Tolerance	Test Condition	DCR (Ω) max.	IDC (A) max.
100	10	M	100KHz, 1.0V	0.044	2.50
150	15	M	100KHz, 1.0V	0.057	2.20
220	22	M	100KHz, 1.0V	0.071	1.90
330	33	M	100KHz, 1.0V	0.100	1.60
470	47	M	100KHz, 1.0V	0.120	1.40
680	68	M	100KHz, 1.0V	0.170	1.20
101	100	M	100KHz, 1.0V	0.240	1.00
151	150	M	100KHz, 1.0V	0.420	0.79
221	220	M	100KHz, 1.0V	0.570	0.65
331	330	M	100KHz, 1.0V	0.820	0.54
471	470	M	100KHz, 1.0V	1.240	0.47
681	680	M	100KHz, 1.0V	1.920	0.38
102	1000	M	100KHz, 1.0V	3.360	0.29
152	1500	M	100KHz, 1.0V	4.080	0.22

### 1313

Codes	L (μH)	Tolerance	Test Condition	DCR (Ω) max.	IDC (A) max.
6R0	6	M	100KHz,1.0V	0.020	3.60
100	10	M	100KHz,1.0V	0.026	3.40
150	15	M	100KHz,1.0V	0.032	2.80
220	22	M	100KHz,1.0V	0.041	2.30
330	33	M	100KHz,1.0V	0.050	1.90
470	47	M	100KHz,1.0V	0.075	1.60
680	68	M	100KHz,1.0V	0.100	1.30
101	100	M	100KHz,1.0V	0.140	1.10
151	150	M	100KHz,1.0V	0.230	0.88
221	220	M	100KHz,1.0V	0.330	0.72
331	330	M	100KHz,1.0V	0.500	0.59
471	470	M	100KHz,1.0V	0.630	0.49
681	680	M	100KHz,1.0V	0.920	0.43
102	1000	M	100KHz,1.0V	1.350	0.34
152	1500	M	100KHz,1.0V	2.080	0.29

# LMax SMD Power Inductor

## LMXS Series – Shielded Style F



### 131H

Codes	L (μH)	Tolerance	Test Condition	DCR (Ω) max.	IDC (A) max.
2R0	2.0	M	100KHz,1.0V	0.014	6.20
4R2	4.2	M	100KHz,1.0V	0.018	5.50
7R0	7.0	M	100KHz,1.0V	0.022	5.00
100	10	M	100KHz,1.0V	0.025	4.80
150	15	M	100KHz,1.0V	0.029	4.20
220	22	M	100KHz,1.0V	0.038	3.50
330	33	M	100KHz,1.0V	0.049	2.80
470	47	M	100KHz,1.0V	0.070	2.40
680	68	M	100KHz,1.0V	0.095	2.00
101	100	M	100KHz,1.0V	0.150	1.60
221	220	M	100KHz,1.0V	0.330	1.00

### 131J

Codes	L (μH)	Tolerance	Test Condition	DCR (Ω) max.	IDC (A) max.
1R2	1.2	M	100KHz,1.0V	0.009	8.20
2R7	2.7	M	100KHz,1.0V	0.012	7.00
3R9	3.9	M	100KHz,1.0V	0.013	6.70
5R6	5.6	M	100KHz,1.0V	0.014	6.30
6R8	6.8	M	100KHz,1.0V	0.016	5.90
100	10	M	100KHz,1.0V	0.019	5.40
150	15	M	100KHz,1.0V	0.022	4.70
220	22	M	100KHz,1.0V	0.032	4.00
330	33	M	100KHz,1.0V	0.048	3.20
470	47	M	100KHz,1.0V	0.064	2.70
680	68	M	100KHz,1.0V	0.094	2.00
101	100	M	100KHz,1.0V	0.150	1.90
151	150	M	100KHz,1.0V	0.210	1.50
221	220	M	100KHz,1.0V	0.310	1.30

# LMax SMD Power Inductor

## LMXS Series – Shielded Style G

### FEATURES

- Magnetically Shielded Construction
- Large Current
- Low DCR

### APPLICATIONS

- LCD Televisions
- Notebooks
- Handheld Communication
- DC/DC Converters, etc.

### DIMENSIONS

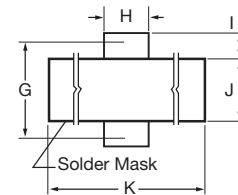
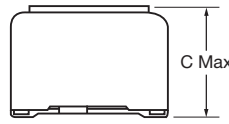
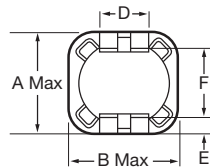

mm (inches)

Type	A max.	B max.	C max.	D	E	F	G	H	I	J	K
0707	7.50 (0.295)	7.50 (0.295)	3.50 (0.138)	2.00 (0.079)	1.10 (0.043)	5.08 (0.200)	6.30 (0.248)	3.00 (0.118)	1.91 (0.075)	4.50 (0.177)	10.5 (0.413)
07D7	7.50 (0.295)	7.50 (0.295)	4.50 (0.177)	2.00 (0.079)	1.10 (0.043)	5.08 (0.200)	6.30 (0.248)	3.00 (0.118)	1.91 (0.075)	4.50 (0.177)	10.5 (0.413)

### CHARACTERISTICS

- Rated Current (IDC): The DC current that will cause an approximate  $\Delta T$  of 40°C. (Ta=25°C)
- Operating temperature range: -40°C ~ +125°C

### INDUCTANCE AND RATED CURRENT RANGES

- 0707 10 $\mu$ H ~ 1000 $\mu$ H 1.68 ~ 0.16A
- 07D7 10 $\mu$ H ~ 1000 $\mu$ H 1.84 ~ 0.18A
- Electrical specifications at 25°C



### HOW TO ORDER

<b>LM</b>	<b>XS</b>	<b>0707</b>	<b>M</b>	<b>R04</b>	<b>G</b>	<b>T</b>	<b>A</b>	<b>S</b>
<b>Family</b>	<b>Series</b>	<b>Size</b>	<b>Tolerance</b>	<b>Inductance</b>	<b>Style</b>	<b>Termination</b>	<b>Special</b>	<b>Packaging</b>
LM = Power Inductor	XS = Shielded	0707 = 7x7xh 07C7 = 7x7xC(h) (h = see catalog)	M = $\pm 20\%$	3R9 = 3.900 $\mu$ H 390 = 39.00 $\mu$ H 391 = 390 $\mu$ H 102 = 1000 $\mu$ H		T = Sn Plate	A = Standard	S = 13" Reel

# LMax SMD Power Inductor

## LMXS Series – Shielded Style G



### ELECTRICAL CHARACTERISTICS

#### 0707

Codes	L (μH)	Tolerance	Test Condition	DCR (Ω) max.	IDC (A) max.
100	10	M	100KHz, 1.0V	0.072	1.68
120	12	M	100KHz, 1.0V	0.098	1.52
150	15	M	100KHz, 1.0V	0.130	1.33
180	18	M	100KHz, 1.0V	0.140	1.20
220	22	M	100KHz, 1.0V	0.190	1.07
270	27	M	100KHz, 1.0V	0.210	0.96
330	33	M	100KHz, 1.0V	0.240	0.91
390	39	M	100KHz, 1.0V	0.320	0.77
470	47	M	100KHz, 1.0V	0.360	0.76
560	56	M	100KHz, 1.0V	0.470	0.68
680	68	M	100KHz, 1.0V	0.520	0.61
820	82	M	100KHz, 1.0V	0.690	0.57
101	100	M	100KHz, 1.0V	0.790	0.50
121	120	M	100KHz, 1.0V	0.890	0.49
151	150	M	100KHz, 1.0V	1.270	0.43
181	180	M	100KHz, 1.0V	1.450	0.39
221	220	M	100KHz, 1.0V	1.650	0.35
271	270	M	100KHz, 1.0V	2.310	0.32
331	330	M	100KHz, 1.0V	2.620	0.28
391	390	M	100KHz, 1.0V	2.940	0.26
471	470	M	100KHz, 1.0V	4.180	0.24
561	560	M	100KHz, 1.0V	4.670	0.22
681	680	M	100KHz, 1.0V	5.730	0.19
821	820	M	100KHz, 1.0V	6.540	0.18
102	1000	M	100KHz, 1.0V	9.440	0.16

#### 07D7

Codes	L (μH)	Tolerance	Test Condition	DCR (Ω) max.	IDC (A) max.
100	10	M	100KHz, 1.0V	0.060	1.84
120	12	M	100KHz, 1.0V	0.070	1.71
150	15	M	100KHz, 1.0V	0.081	1.47
180	18	M	100KHz, 1.0V	0.091	1.31
220	22	M	100KHz, 1.0V	0.110	1.23
270	27	M	100KHz, 1.0V	0.150	1.12
330	33	M	100KHz, 1.0V	0.170	0.96
390	39	M	100KHz, 1.0V	0.230	0.91
470	47	M	100KHz, 1.0V	0.260	0.88
560	56	M	100KHz, 1.0V	0.350	0.75
680	68	M	100KHz, 1.0V	0.380	0.69
820	82	M	100KHz, 1.0V	0.430	0.61
101	100	M	100KHz, 1.0V	0.610	0.60
121	120	M	100KHz, 1.0V	0.660	0.52
151	150	M	100KHz, 1.0V	0.880	0.46
181	180	M	100KHz, 1.0V	0.980	0.42
221	220	M	100KHz, 1.0V	1.170	0.36
271	270	M	100KHz, 1.0V	1.640	0.34
331	330	M	100KHz, 1.0V	1.860	0.32
391	390	M	100KHz, 1.0V	2.850	0.29
561	560	M	100KHz, 1.0V	3.620	0.23
681	680	M	100KHz, 1.0V	4.630	0.22
821	820	M	100KHz, 1.0V	5.200	0.20
102	1000	M	100KHz, 1.0V	6.000	0.18



The Important Information/Disclaimer is incorporated in the catalog where these specifications came from or available online at [www.avx.com/disclaimer/](http://www.avx.com/disclaimer/) by reference and should be reviewed in full before placing any order.

# LMax SMD Power Inductor

## LMXS Series – Shielded Style H

### FEATURES

- Magnetically Shielded Construction
- Large Current
- Low DCR

### APPLICATIONS

- LCD Televisions
- Notebooks
- Handheld Communication
- DC/DC Converters, etc.

### DIMENSIONS

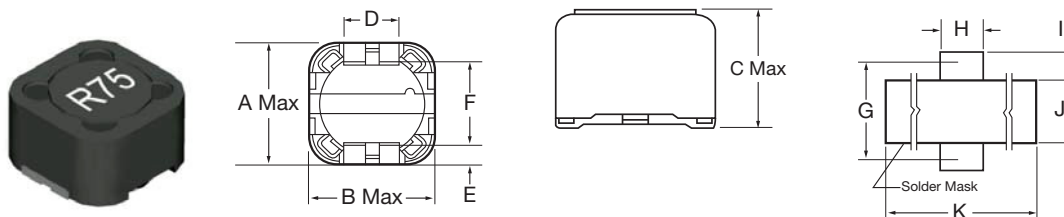

mm (inches)

Type	A max.	B max.	C max.	D	E	F	G	H	I	J	K
1212	12.5 (0.492)	12.5 (0.492)	4.50 (0.177)	5.00 (0.197)	2.00 (0.079)	7.60 (0.299)	10.00 (0.393)	6.00 (0.236)	3.00 (0.118)	7.00 (0.276)	18.0 (0.709)
121G	12.5 (0.492)	12.5 (0.492)	6.20 (0.244)	5.00 (0.197)	2.00 (0.079)	7.60 (0.299)	10.00 (0.394)	6.00 (0.236)	3.00 (0.118)	7.00 (0.276)	18.0 (0.709)
121J	12.5 (0.492)	12.5 (0.492)	8.00 (0.315)	5.00 (0.197)	2.00 (0.079)	7.60 (0.299)	10.00 (0.394)	6.00 (0.236)	3.00 (0.118)	7.00 (0.276)	18.0 (0.709)

### CHARACTERISTICS

- Rated Current (IDC): The DC Current that will cause a drop in inductance value of approximately 20%.
- Operating temperature range: -40°C ~ +125°C

### INDUCTANCE AND RATED CURRENT RANGES

- 1212 3.9μH ~ 330μH 6.5 ~ 0.50A
- 121G 2.4μH ~ 47μH 8.0 ~ 2.5A
- 121J 10μH ~ 1000μH 4.0 ~ 0.40A
- Electrical specifications at 25°C



### HOW TO ORDER

<b>LM</b>	<b>XS</b>	<b>1212</b>	<b>M</b>	<b>R04</b>	<b>H</b>	<b>T</b>	<b>A</b>	<b>S</b>
<b>Family</b>	<b>Series</b>	<b>Size</b>	<b>Tolerance</b>	<b>Inductance</b>	<b>Style</b>	<b>Termination</b>	<b>Special</b>	<b>Packaging</b>
LM = Power Inductor	XS = Shielded	1212 = 12x12xh 121G = 12x12xG(h) (h = see catalog)	M = ±20%	3R9 = 3.900μH 390 = 39.00μH 391 = 390μH 102 = 1000μH		T = Sn Plate	A = Standard	S = 13" Reel

# LMax SMD Power Inductor

## LMXS Series – Shielded Style H

### ELECTRICAL CHARACTERISTICS

#### 1212

Codes	L (μH)	Tolerance	Test Condition	DCR (Ω) max.	IDC (A) max.
3R9	3.9	M	100KHz, 1.0V	0.015	6.50
4R7	4.7	M	100KHz, 1.0V	0.018	5.70
6R8	6.8	M	100KHz, 1.0V	0.023	4.90
100	10	M	100KHz, 1.0V	0.028	4.50
120	12	M	100KHz, 1.0V	0.038	4.00
150	15	M	100KHz, 1.0V	0.050	3.20
180	18	M	100KHz, 1.0V	0.057	3.10
220	22	M	100KHz, 1.0V	0.066	2.90
270	27	M	100KHz, 1.0V	0.080	2.80
330	33	M	100KHz, 1.0V	0.097	2.70
390	39	M	100KHz, 1.0V	0.132	2.10
470	47	M	100KHz, 1.0V	0.150	1.90
560	56	M	100KHz, 1.0V	0.190	1.80
680	68	M	100KHz, 1.0V	0.220	1.50
820	82	M	100KHz, 1.0V	0.260	1.30
101	100	M	100KHz, 1.0V	0.308	1.20
121	120	M	100KHz, 1.0V	0.380	1.10
151	150	M	100KHz, 1.0V	0.530	0.95
181	180	M	100KHz, 1.0V	0.620	0.85
221	220	M	100KHz, 1.0V	0.700	0.80
271	270	M	100KHz, 1.0V	0.876	0.60
331	330	M	100KHz, 1.0V	0.990	0.50

#### 121G

Codes	L (μH)	Tolerance	Test Condition	DCR (Ω) max.	IDC (A) max.
100	10	M	100KHz, 1.0V	0.025	4.00
120	12	M	100KHz, 1.0V	0.027	3.50
150	15	M	100KHz, 1.0V	0.030	3.30
180	18	M	100KHz, 1.0V	0.038	3.00
220	22	M	100KHz, 1.0V	0.045	2.80
270	27	M	100KHz, 1.0V	0.055	2.30
330	33	M	100KHz, 1.0V	0.063	2.10
390	39	M	100KHz, 1.0V	0.075	2.00
470	47	M	100KHz, 1.0V	0.085	1.80
560	56	M	100KHz, 1.0V	0.110	1.70
680	68	M	100KHz, 1.0V	0.120	1.50
820	82	M	100KHz, 1.0V	0.140	1040
101	100	M	100KHz, 1.0V	0.165	1.30
121	120	M	100KHz, 1.0V	0.195	1.10
151	150	M	100KHz, 1.0V	0.250	1.00
181	180	M	100KHz, 1.0V	0.290	0.90
221	220	M	100KHz, 1.0V	00400	0.80
271	270	M	100KHz, 1.0V	00460	0.75
331	330	M	100KHz, 1.0V	0.510	0.68
391	390	M	100KHz, 1.0V	0.690	0.65
471	470	M	100KHz, 1.0V	0.770	0.58
561	560	M	100KHz, 1.0V	0.880	0.54
681	680	M	100KHz, 1.0V	1.200	0048
821	820	M	100KHz, 1.0V	1.340	0043
102	1000	M	100KHz, 1.0V	1.530	0040



# LMax SMD Power Inductor

## LMXS Series – Shielded Style H



### 121J

Codes	L (μH)	Tolerance	Test Condition	DCR (Ω) max.	IDC (A) max.
2R4	2.4	M	100KHz, 1.0V	0.012	8.00
4R7	4.7	M	100KHz, 1.0V	0.016	6.80
7R6	7.6	M	100KHz, 1.0V	0.020	5.90
100	10	M	100KHz, 1.0V	0.022	5.40
120	12	M	100KHz, 1.0V	0.025	4.90
150	15	M	100KHz, 1.0V	0.027	4.50
180	18	M	100KHz, 1.0V	0.039	3.90
220	22	M	100KHz, 1.0V	0.043	3.60
270	27	M	100KHz, 1.0V	0.046	3.40
330	33	M	100KHz, 1.0V	0.065	3.00
390	39	M	100KHz, 1.0V	0.073	2.75
470	47	M	100KHz, 1.0V	0.100	2.50

# LMax SMD Power Inductor

## LMXS Series – Shielded Style J

### FEATURES

- Directly connected electrode on ferrite core
- High power, High saturation inductors
- Ideal inductors for DC/DC converters
- Magnetically shielded against radiation
- Available on tape and reel for automatic surface mounting

### APPLICATIONS

- Power Supply for VTRs
- LCD Televisions
- Notebook PCs
- Portable Communication
- DC/DC Converters, etc.

### DIMENSIONS

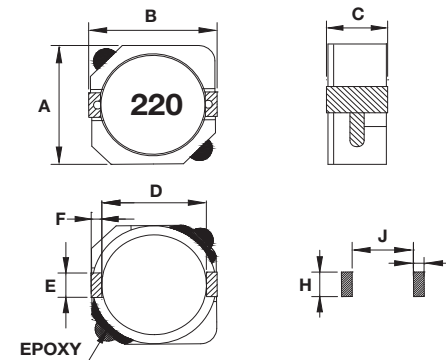

### CHARACTERISTICS

- Rated DC current: The current when the inductance becomes 35% lower than its initial value or the actual current when the temperature of coil increases to  $\Delta T=40^{\circ}\text{C}$ . The smaller one is defined as Rated DC Current. ( $T_a=25^{\circ}\text{C}$ )
- Operating temperature range:  $-40 \sim 85^{\circ}\text{C}$

### INDUCTANCE AND RATED CURRENT RANGES

- 0606 2.5 ~ 100 $\mu\text{H}$  2.60 ~ 0.40A
- 1010 10 ~ 150 $\mu\text{H}$  2.70 ~ 0.70A
- 101D 1.3 ~ 330 $\mu\text{H}$  10.0 ~ 0.70A
- 101E 1.5 ~ 1000 $\mu\text{H}$  10.5 ~ 0.35A
- Electrical specifications at  $25^{\circ}\text{C}$

mm (inches)

Type	A max.	B max.	C max.	D	E	F	H	I	J
0606	6.20 (0.244)	6.30 (0.248)	3.00 (0.118)	4.70 (0.185)	2.00 (0.079)	0.60 (0.024)	2.60 (0.102)	1.00 (0.039)	4.60 (0.181)
1010	10.3 (0.406)	10.4 (0.409)	3.10 (0.122)	7.70 (0.303)	3.00 (0.118)	1.20 (0.047)	3.20 (0.126)	1.60 (0.063)	7.30 (0.287)
101D	10.3 (0.406)	10.4 (0.409)	4.00 (0.157)	7.70 (0.303)	3.00 (0.118)	1.20 (0.047)	3.20 (0.126)	1.60 (0.063)	7.30 (0.287)
101E	10.3 (0.406)	10.4 (0.409)	5.00 (0.197)	7.70 (0.303)	3.00 (0.118)	1.20 (0.047)	3.20 (0.126)	1.60 (0.063)	7.30 (0.287)

### HOW TO ORDER

<b>LM</b>	<b>XS</b>	<b>0606</b>	<b>N</b>	<b>R04</b>	<b>J</b>	<b>T</b>	<b>A</b>	<b>S</b>
<b>Family</b>	<b>Series</b>	<b>Size</b>	<b>Tolerance</b>	<b>Inductance</b>	<b>Style</b>	<b>Termination</b>	<b>Special</b>	<b>Packaging</b>
LM = Power Inductor	XS = Shielded	0606 = 6x6xh 1010 = 10x10xh 101D = 10x10xD(h) (h = see catalog)	N = $\pm 30\%$	R04 = 0.039 $\mu\text{H}$ R39 = 0.390 $\mu\text{H}$ 3R9 = 3.900 $\mu\text{H}$ 390 = 39.00 $\mu\text{H}$ 391 = 390.0 $\mu\text{H}$ 392 = 3900 $\mu\text{H}$		T = Sn Plate	A = Standard	S = 13" Reel

# LMax SMD Power Inductor

## LMXS Series – Shielded Style J



### 0606/1010/101D/101E

Codes	L (µH)	Tolerance	Test Condition	DCR (Ω) max.				IDC (A) max.			
				0606	1010	101D	101E	0606	1010	101D	101E
1R3	1.3	N	100KHz, 0.1V	-	-	0.008	-	-	-	10.0	-
1R5	1.5	N	100KHz, 0.1V	-	-	0.008	0.006	-	-	10.0	10.5
2R2	2.2	N	100KHz, 0.1V	-	-	0.011	0.007	-	-	8.00	9.25
2R5	2.5	N	100KHz, 0.1V	0.0176	-	0.012	-	2.60	-	7.50	-
3R3	3.3	N	100KHz, 0.1V	0.0203	-	0.013	0.010	2.30	-	6.50	7.80
3R8	3.8	N	100KHz, 0.1V	-	-	0.017	-	-	-	6.00	-
4R0	4.0	N	100KHz, 0.1V	0.027	-	-	-	2.10	-	-	-
4R7	4.7	N	100KHz, 0.1V	-	-	0.021	0.012	-	-	5.70	6.40
5R0	5.0	N	100KHz, 0.1V	0.0311	-	-	-	1.85	-	-	-
5R2	5.2	N	100KHz, 0.1V	-	-	0.022	-	-	-	5.50	-
5R6	5.6	N	100KHz, 0.1V	-	-	0.025	-	-	-	5.20	-
6R0	6.0	N	100KHz, 0.1V	0.0419	-	-	-	1.70	-	-	-
6R8	6.8	N	100KHz, 0.1V	-	-	0.026	0.018	-	-	4.90	5.40
7R0	7.0	N	100KHz, 0.1V	-	-	0.027	-	-	-	4.80	-
8R0	8.0	N	100KHz, 0.1V	0.0499	-	-	-	1.50	-	-	-
8R2	8.2	N	100KHz, 0.1V	-	-	-	0.020	-	-	-	4.85
100	10	N	100KHz, 0.1V	0.054	0.058	0.035	0.026	1.30	2.70	4.40	3.45
120	12	N	100KHz, 0.1V	0.0716	0.072	-	0.033	1.20	2.25	-	3.40
150	15	N	100KHz, 0.1V	0.0824	0.086	0.050	0.041	1.10	2.22	3.60	2.83
180	18	N	100KHz, 0.1V	0.1015	0.116	-	0.046	1.05	1.90	-	2.62
220	22	N	100KHz, 0.1V	0.119	0.145	0.073	61	0.95	1.78	2.90	2.44
270	27	N	100KHz, 0.1V	0.146	0.176	0.083	0.069	0.85	1.63	2.80	2.24
330	33	N	100KHz, 0.1V	0.1825	0.213	0.093	0.084	0.76	1.46	2.30	1.88
390	39	N	100KHz, 0.1V	0.2095	0.270	-	0.106	0.68	1.32	-	1.70
470	47	N	100KHz, 0.1V	0.2295	0.299	0.128	0.130	0.60	1.18	2.10	1.56
560	56	N	100KHz, 0.1V	0.305	0.335	-	0.149	0.55	1.10	-	1.39
680	68	N	100KHz, 0.1V	0.351	0.451	0.213	0.201	0.48	1.04	1.50	1.36
820	82	N	100KHz, 0.1V	0.4185	0.513	-	0.227	0.45	0.94	-	1.20
101	100	N	100KHz, 0.1V	0.520	0.700	0.304	0.253	0.40	0.84	1.35	1.09
121	120	N	100KHz, 0.1V	-	0.765	-	0.303	-	0.76	-	1.00
151	150	N	100KHz, 0.1V	-	0.876	0.506	0.370	-	0.70	1.15	0.91
181	180	N	100KHz, 0.1V	-	-	0.631	0.419	-	-	1.03	0.84
221	220	N	100KHz, 0.1V	-	-	0.756	0.500	-	-	0.92	0.75
271	270	N	100KHz, 0.1V	-	-	-	0.672	-	-	-	0.68
331	330	N	100KHz, 0.1V	-	-	1.09	0.812	-	-	0.70	0.60
391	390	N	100KHz, 0.1V	-	-	-	0.953	-	-	-	0.57
471	470	N	100KHz, 0.1V	-	-	-	1.289	-	-	-	0.50
561	560	N	100KHz, 0.1V	-	-	-	1.430	-	-	-	0.47
681	680	N	100KHz, 0.1V	-	-	-	1.599	-	-	-	0.43
821	820	N	100KHz, 0.1V	-	-	-	1.768	-	-	-	0.39
102	1000	N	100KHz, 0.1V	-	-	-	1.989	-	-	-	0.35

# LMax SMD Power Inductor

## LMXS Series – Shielded Style L

### FEATURES

- Magnetically Shielded Construction
- Large Current
- Low DCR

### APPLICATIONS

- LCD Televisions
- Notebooks
- Camcorders
- Digital Cameras
- DC/DC Converters for Portable Devices

### DIMENSIONS

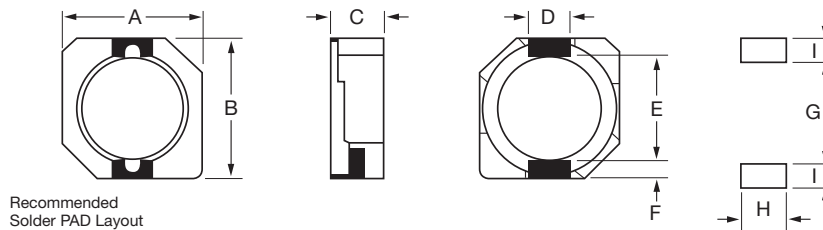

### CHARACTERISTICS

- Rated Current (IDC): The DC current that will cause an approximate  $\Delta T$  of 40°C. (Ta=25°C)
- Operating temperature range: -40°C ~ +125°C

### INDUCTANCE AND RATED CURRENT RANGES

- 1010 0.8uH ~ 47.0uH 11.2 ~ 1.43A
- 101D 1.5uH ~ 330uH 10.0 ~ 0.70A
- Electrical specifications at 25°C

mm (inches)

Type	A max	B max	C max	D	E	F	G	H	I
1010	10.3 (0.398)	10.5 (0.414)	3.10 (0.122)	3.00 ± 0.10 (0.119 ± 0.004)	7.70 ± 0.30 (0.303 ± 0.012)	1.20 ± 0.150 (0.048 ± 0.006)	7.30 (0.288)	3.20 (0.126)	1.60 (0.630)
101D	10.3 (0.398)	10.5 (0.414)	3.80 ± 0.20 (0.150 ± 0.008)	3.00 ± 0.1 (0.119 ± 0.004)	7.70 ± 0.30 (0.303 ± 0.012)	1.2 ± 0.15 (0.048 ± 0.006)	7.30 (0.288)	3.20 (0.126)	1.60 (0.630)

### HOW TO ORDER

<b>LM</b>	<b>XS</b>	<b>1010</b>	<b>N</b>	<b>2R2</b>	<b>L</b>	<b>T</b>	<b>A</b>	<b>S</b>
<b>Family</b>	<b>Series</b>	<b>Size</b>	<b>Tolerance</b>	<b>Inductance</b>	<b>Style</b>	<b>Termination</b>	<b>Special</b>	<b>Packaging</b>
LM = Power Inductor	XS = Shielded	1010 = 10x10xh 101D = 10x10xD(h) (h = see catalog)	N = ±30%	0R8 = 0.8µH 470 = 47.00µH 331 = 330.0µH		T = Sn Plate	A = Standard	S = 13" Reel

# LMax SMD Power Inductor

## LMXS Series – Shielded Style L



### ELECTRICAL CHARACTERISTICS

#### 1010

Codes	L (μH)	Tolerance	Test Condition	DCR (Ω) max.	IDC (A) max.
0R8	0.8	N	100KHz, 1.0V	0.0057	11.2
1R5	1.5	N	100KHz, 1.0V	0.011	8.00
2R2	2.2	N	100KHz, 1.0V	0.0159	6.70
3R3	3.3	N	100KHz, 1.0V	0.021	5.56
4R7	4.7	N	100KHz, 1.0V	0.030	4.55
6R8	6.8	N	100KHz, 1.0V	0.035	3.84
8R0	8.0	N	100KHz, 1.0V	0.050	3.54
100	10	N	100KHz, 1.0V	0.059	3.18
150	15	N	100KHz, 1.0V	0.091	2.60
220	22	N	100KHz, 1.0V	0.143	2.16
330	33	N	100KHz, 1.0V	0.202	1.74
470	47	N	100KHz, 1.0V	0.299	1.43

#### 101D

Codes	L (μH)	Tolerance	Test Condition	DCR (Ω) max.	IDC (A) max.
1R5	1.5	N	100KHz, 1.0V	0.0081	10.0
2R5	2.5	N	100KHz, 1.0V	0.010	7.50
3R8	3.8	N	100KHz, 1.0V	0.013	6.00
4R7	4.7	N	100KHz, 1.0V	0.022	5.50
5R2	5.2	N	100KHz, 1.0V	0.022	5.50
7R0	7.0	N	100KHz, 1.0V	0.027	4.80
100	10	N	100KHz, 1.0V	0.035	4.40
150	15	N	100KHz, 1.0V	0.050	3.60
220	22	N	100KHz, 1.0V	0.073	2.90
330	33	N	100KHz, 1.0V	0.093	2.30
470	47	N	100KHz, 1.0V	0.128	2.10
680	68	N	100KHz, 1.0V	0.213	1.50
101	100	N	100KHz, 1.0V	0.304	1.35
151	150	N	100KHz, 1.0V	0.506	1.15
221	220	N	100KHz, 1.0V	0.756	0.92
331	330	N	100KHz, 1.0V	1.090	0.70

# LMax SMD Power Inductor

## LMXS Series – Shielded Style M

### FEATURES

- Magnetically shielded construction
- RoHS compliance

### APPLICATIONS

- LCD TV
- DC to DC Converters
- Notebook PC

### INDUCTANCE AND RATED CURRENT RANGES

- 0808 1.0 ~ 100μH 6.5 ~ 0.75A
- 08D8 1.8 ~ 100μH 7.0 ~ 1.05A
- 08E8 1.0 ~ 100μH 9.0 ~ 1.30A
- Electrical specifications at 25°C



### CHARACTERISTICS

- Rated DC Current: The current when the inductance becomes 35% lower than its initial value.
- Operating temperature: -40 ~ 85°C

### DIMENSIONS

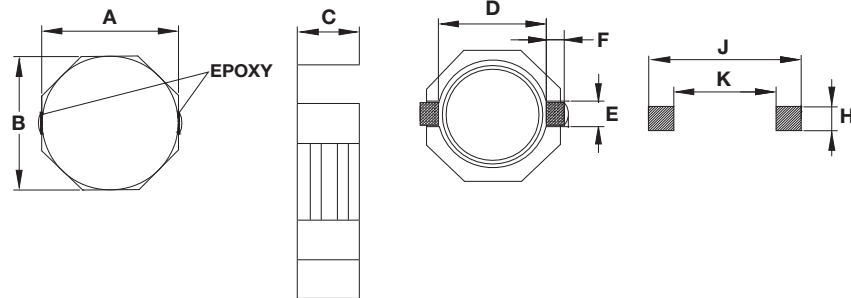

mm (inches)

Type	A	B	C max.	D Ref.	E Ref.	F Ref.	H	J	K
0808	8.00 ± 0.30 (0.315 ± 0.012)	8.00 ± 0.30 (0.315 ± 0.012)	3.00 (0.118)	6.30 (0.248)	2.50 (0.098)	1.20 (0.047)	2.80 (0.110)	10.1 (0.398)	6.10 (0.240)
08D8	8.00 ± 0.30 (0.315 ± 0.012)	8.00 ± 0.30 (0.315 ± 0.012)	4.00 (0.157)	6.30 (0.248)	2.50 (0.098)	1.20 (0.047)	2.80 (0.110)	10.1 (0.398)	6.10 (0.240)
08E8	8.0 ± 0.30 (0.315 ± 0.012)	8.00 ± 0.30 (0.315 ± 0.012)	4.50 (0.177)	6.30 (0.248)	2.50 (0.098)	1.20 (0.047)	2.80 (0.110)	10.1 (0.398)	6.10 (0.240)

### HOW TO ORDER

<b>LM</b>	<b>XS</b>	<b>0808</b>	<b>N</b>	<b>R04</b>	<b>M</b>	<b>T</b>	<b>A</b>	<b>S</b>
<b>Family</b>	<b>Series</b>	<b>Size</b>	<b>Tolerance</b>	<b>Inductance</b>	<b>Style</b>	<b>Termination</b>	<b>Special</b>	<b>Packaging</b>
LM = Power Inductor	XN = Non-shielded	0808 = 8x8xh 08D8 = 8x8xD(h) (h = see catalog)	N = ±30%	3R9 = 3.900μH 390 = 39.00μH 391 = 390.0μH 392 = 3900μH		T = Sn Plate	A = Standard	S = 13" Reel

# LMax SMD Power Inductor

## LMXS Series – Shielded Style M



### ELECTRICAL CHARACTERISTICS

#### 0808/08D8/08E8

Codes	L ( $\mu$ H)	Tolerance	Test Condition		DCR ( $\Omega$ ) max.			I sat (A) max*		
			0808	08D8/08E8	0808	08D8	08E8	0808	08D8	0838
1R0	1.0	N	100KHz, 0.25V	100KHz, 0.1V	0.011	–	0.0095	6.5	–	9.0
1R2	1.2	N	100KHz, 0.25V	100KHz, 0.1V	–	–	0.0122	–	–	8.0
1R8	1.8	N	100KHz, 0.25V	100KHz, 0.1V	–	0.0156	–	–	7.0	–
2R0	2.0	N	100KHz, 0.25V	100KHz, 0.1V	–	–	0.014	–	–	7.0
2R5	2.5	N	100KHz, 0.25V	100KHz, 0.1V	0.0156	0.0175	–	4.5	6.5	–
3R3	3.3	N	100KHz, 0.25V	100KHz, 0.1V	0.0182	–	–	4.0	–	–
3R5	3.5	N	100KHz, 0.25V	100KHz, 0.1V	–	0.024	–	–	5.0	–
3R9	3.9	N	100KHz, 0.25V	100KHz, 0.1V	–	–	0.019	–	–	5.9
4R7	4.7	N	100KHz, 0.25V	100KHz, 0.1V	0.0247	0.029	0.022	3.4	4.6	5.6
6R0	6.0	N	100KHz, 0.25V	100KHz, 0.1V	–	0.032	–	–	4.2	–
6R8	6.8	N	100KHz, 0.25V	100KHz, 0.1V	–	–	0.025	–	–	4.4
7R3	7.3	N	100KHz, 0.25V	100KHz, 0.1V	0.039	–	–	2.80	–	–
100	10	N	100KHz, 0.25V	100KHz, 0.1V	0.047	0.048	0.036	2.50	3.00	4.0
150	15	N	100KHz, 0.25V	100KHz, 0.1V	0.069	0.067	0.053	1.90	2.75	2.9
220	22	N	100KHz, 0.25V	100KHz, 0.1V	0.099	0.105	0.075	1.60	2.30	2.6
330	33	N	100KHz, 0.25V	100KHz, 0.1V	0.156	0.157	0.125	1.30	1.75	2.2
470	47	N	100KHz, 0.25V	100KHz, 0.1V	0.159	0.189	0.150	1.15	1.52	1.8
680	68	N	100KHz, 0.25V	100KHz, 0.1V	0.286	0.290	0.240	0.92	1.30	1.5
101	100	N	100KHz, 0.25V	100KHz, 0.1V	0.430	0.410	0.360	0.75	1.05	1.3

\*Saturation Current: The current when the inductance becomes 35% lower than its initial value.

# LMax SMD Power Inductor

## LMXS Series – Shielded Style P

### FEATURES

- Magnetically Shielded Construction
- Large Current
- Low DCR

### APPLICATIONS

- LCD Televisions
- Notebooks
- Camcorders
- Digital Cameras
- DC/DC Converters for Portable Devices

### CHARACTERISTICS

- Rated Current (IDC): The DC current that will cause an approximate  $\Delta T$  of 40°C. (Ta=25°C)
- Operating temperature range: -40°C ~ +125°C

### DIMENSIONS

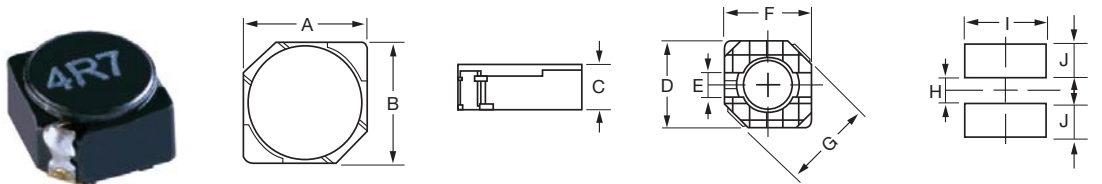

Recommended Solder PAD Layout

mm (inches)

Type	A	B max	C max	D	E	F max	G max	H	I
0404	3.80 ± 0.50 (0.150 ± 0.012)	3.80 ± 0.50 (0.150 ± 0.012)	1.80 ± 0.20 (0.071 ± .008)	3.80 (0.150)	1.10 (0.044)	3.80 (0.150)	5.00 (0.196)	1.10 (0.044)	4.60 (0.181)
0505	4.70 ± 0.50 (0.185 ± 0.012)	4.70 ± 0.50 (0.185 ± 0.012)	2.00 (0.079)	4.50 (0.177)	1.50 (0.059)	4.50 (0.177)	6.90 (0.272)	1.50 (0.059)	5.30 (0.209)
05C5	4.70 ± 0.50 (0.185 ± 0.012)	4.70 ± 0.50 (0.185 ± 0.012)	3.00 (0.119)	4.50 (0.177)	1.50 (0.059)	4.50 (0.177)	6.90 (0.272)	1.50 (0.059)	5.30 (0.209)
0606	5.7 ± 0.50 (0.225 ± 0.012)	5.70 ± 0.50 (0.225 ± 0.012)	2.10 (0.083)	5.50 (0.217)	2.00 (0.079)	5.50 (0.217)	8.20 (0.323)	2.00 (0.079)	6.30 (0.248)
06C6	5.70 ± 0.50 (0.225 ± 0.012)	5.70 ± 0.50 (0.225 ± 0.012)	3.00 (0.119)	5.50 (0.217)	2.00 (0.079)	5.50 (0.217)	8.20 (0.323)	2.00 (0.079)	6.30 (0.248)
0707	6.70 ± 0.40 (0.264 ± 0.158)	6.70 ± 0.40 (0.264 ± 0.158)	1.90 (0.075)	6.50 (0.256)	2.00 (0.079)	6.50 (0.256)	9.50 (0.375)	2.00 (0.079)	7.30 (0.288)
07C7	6.70 ± 0.50 (0.264 ± 0.012)	6.70 ± 0.50 (0.264 ± 0.012)	3.00 (0.119)	6.50 (0.256)	2.00 (0.079)	6.50 (0.256)	9.50 (0.375)	2.00 (0.079)	7.30 (0.288)
07D7	6.70 ± 0.50 (0.264 ± 0.012)	6.70 ± 0.50 (0.264 ± 0.012)	4.00 (0.158)	6.50 (0.256)	2.00 (0.079)	6.50 (0.256)	9.50 (0.375)	2.00 (0.079)	7.30 (0.288)

### HOW TO ORDER

<b>LM</b>	<b>XS</b>	<b>0505</b>	<b>M</b>	<b>2R2</b>	<b>P</b>	<b>T</b>	<b>A</b>	<b>S</b>
<b>Family</b>	<b>Series</b>	<b>Size</b>	<b>Tolerance</b>	<b>Inductance</b>	<b>Style</b>	<b>Termination</b>	<b>Special</b>	<b>Packaging</b>
LM = Power Inductor	XS = Shielded	0505 = 5x5xh 05C5 = 5x5xC(h) (h = see catalog)	M = ±20%	0R8 = 0.8µH 470 = 47.00µH 331 = 330.0µH		T = Sn Plate	A = Standard	S = 13" Reel



# LMax SMD Power Inductor

## LMXS Series – Shielded Style P



### ELECTRICAL CHARACTERISTICS

#### 0404

Codes	L (μH)	Tolerance	Test Condition	DCR (Ω) max.	IDC (A) max.
1R5	1.5	M	100KHz, 1.0V	0.052	1.55
2R2	2.2	M	100KHz, 1.0V	0.072	1.20
3R3	3.3	M	100KHz, 1.0V	0.085	1.10
4R7	4.7	M	100KHz, 1.0V	0.105	0.90
6R8	6.8	M	100KHz, 1.0V	0.170	0.73
100	10	M	100KHz, 1.0V	0.210	0.55
150	15	M	100KHz, 1.0V	0.295	0.45
220	22	M	100KHz, 1.0V	0.430	0.40
330	33	M	100KHz, 1.0V	0.675	0.32

#### 0505

Codes	L (μH)	Tolerance	Test Condition	DCR (Ω) max.	IDC (A) max.
1R0	1.0	M	100KHz, 1.0V	0.045	1.72
2R2	2.2	M	100KHz, 1.0V	0.060	1.32
2R7	2.7	M	100KHz, 1.0V	0.070	1.28
3R3	3.3	M	100KHz, 1.0V	0.085	1.04
3R9	3.9	M	100KHz, 1.0V	0.110	0.88
4R7	4.7	M	100KHz, 1.0V	0.128	0.84
5R6	5.6	M	100KHz, 1.0V	0.145	0.80
6R8	6.8	M	100KHz, 1.0V	0.158	0.76
8R2	8.2	M	100KHz, 1.0V	0.185	0.68
100	10	M	100KHz, 1.0V	0.200	0.61
120	12	M	100KHz, 1.0V	0.210	0.56
150	15	M	100KHz, 1.0V	0.240	0.50
180	18	M	100KHz, 1.0V	0.338	0.48
220	22	M	100KHz, 1.0V	0.397	0.41
270	27	M	100KHz, 1.0V	0.441	0.35
330	33	M	100KHz, 1.0V	0.694	0.32
390	39	M	100KHz, 1.0V	0.709	0.30

#### 05C5

Codes	L (μH)	Tolerance	Test Condition	DCR (Ω) max.	IDC (A) max.
1R2	1.2	M	100KHz, 1.0V	0.0236	2.56
1R8	1.8	M	100KHz, 1.0V	0.0275	2.20
2R2	2.2	M	100KHz, 1.0V	0.0313	2.04
2R7	2.7	M	100KHz, 1.0V	0.0433	1.60
3R3	3.3	M	100KHz, 1.0V	0.0492	1.57
3R9	3.9	M	100KHz, 1.0V	0.0648	1.44
4R7	4.7	M	100KHz, 1.0V	0.0720	1.32
5R6	5.6	M	100KHz, 1.0V	0.1009	1.17
6R8	6.8	M	100KHz, 1.0V	0.1089	1.12
8R2	8.2	M	100KHz, 1.0V	0.1175	1.04
100	10	M	100KHz, 1.0V	0.1283	1.00
120	12	M	100KHz, 1.0V	0.1316	0.84
150	15	M	100KHz, 1.0V	0.1490	0.76
180	18	M	100KHz, 1.0V	0.1660	0.72
220	22	M	100KHz, 1.0V	0.2350	0.70
270	27	M	100KHz, 1.0V	0.2610	0.58
330	33	M	100KHz, 1.0V	0.3780	0.56
390	39	M	100KHz, 1.0V	0.3837	0.50
470	47	M	100KHz, 1.0V	0.5870	0.48
560	56	M	100KHz, 1.0V	0.6245	0.41
680	68	M	100KHz, 1.0V	0.6990	0.35
820	82	M	100KHz, 1.0V	0.9148	0.32
101	100	M	100KHz, 1.0V	1.020	0.29
121	120	M	100KHz, 1.0V	1.270	0.27
151	150	M	100KHz, 1.0V	1.350	0.24
181	180	M	100KHz, 1.0V	1.540	0.22

# LMax SMD Power Inductor

## LMXS Series – Shielded Style P

### 0606

Codes	L (μH)	Tolerance	Test Condition	DCR (Ω) max.	IDC (A) max.
4R1	4.1	M	100KHz, 1.0V	0.057	1.95
5R4	5.4	M	100KHz, 1.0V	0.076	1.6
6R2	6.2	M	100KHz, 1.0V	0.096	1.4
8R9	8.9	M	100KHz, 1.0V	0.116	1.25
100	10	M	100KHz, 1.0V	0.124	1.2
120	12	M	100KHz, 1.0V	0.153	1.1
150	15	M	100KHz, 1.0V	0.196	0.97
180	18	M	100KHz, 1.0V	0.21	0.85
220	22	M	100KHz, 1.0V	0.29	0.8
270	27	M	100KHz, 1.0V	0.33	0.75
330	33	M	100KHz, 1.0V	0.386	0.65
390	39	M	100KHz, 1.0V	0.52	0.57
470	47	M	100KHz, 1.0V	0.595	0.54
560	56	M	100KHz, 1.0V	0.665	0.5
680	68	M	100KHz, 1.0V	0.84	0.43
820	82	M	100KHz, 1.0V	0.978	0.41
101	100	M	100KHz, 1.0V	1.2	0.36

### 06C6

Codes	L (μH)	Tolerance	Test Condition	DCR (Ω) max.	IDC (A) max.
2R6	2.6	M	100KHz, 1.0V	0.018	2.6
3R0	3	M	100KHz, 1.0V	0.024	2.4
4R2	4.2	M	100KHz, 1.0V	0.031	2.2
5R3	5.3	M	100KHz, 1.0V	0.038	1.9
6R2	6.2	M	100KHz, 1.0V	0.045	1.8
8R2	8.2	M	100KHz, 1.0V	0.053	1.6
100	10	M	100KHz, 1.0V	0.065	1.3
120	12	M	100KHz, 1.0V	0.076	1.2
150	15	M	100KHz, 1.0V	0.103	1.1
180	18	M	100KHz, 1.0V	0.11	1
220	22	M	100KHz, 1.0V	0.122	0.9
270	27	M	100KHz, 1.0V	0.175	0.85
330	33	M	100KHz, 1.0V	0.189	0.75
390	39	M	100KHz, 1.0V	0.212	0.7
470	47	M	100KHz, 1.0V	0.26	0.62
560	56	M	100KHz, 1.0V	0.305	0.58
680	68	M	100KHz, 1.0V	0.355	0.52
820	82	M	100KHz, 1.0V	0.463	0.46
101	100	M	100KHz, 1.0V	0.52	0.42

# LMax SMD Power Inductor

## LMXS Series – Shielded Style P



### 07007

Codes	L (μH)	Tolerance	Test Condition	DCR (Ω) max.	IDC (A) max.
3R3	3.3	M	100KHz, 1.0V	0.069	3
4R7	4.7	M	100KHz, 1.0V	0.075	2.4
6R8	6.8	M	100KHz, 1.0V	0.106	2.2
100	10	M	100KHz, 1.0V	0.15	1.8

### 07C7

Codes	L (μH)	Tolerance	Test Condition	DCR (Ω) max.	IDC (A) max.
3R0	3	M	100KHz, 1.0V	0.024	3
3R9	3.9	M	100KHz, 1.0V	0.027	2.6
5R0	5	M	100KHz, 1.0V	0.031	2.4
6R0	6	M	100KHz, 1.0V	0.035	2.25
7R3	7.3	M	100KHz, 1.0V	0.054	2.1
8R6	8.6	M	100KHz, 1.0V	0.058	1.85
100	10	M	100KHz, 1.0V	0.065	1.7
120	12	M	100KHz, 1.0V	0.07	1.55
150	15	M	100KHz, 1.0V	0.084	1.4
180	18	M	100KHz, 1.0V	0.095	1.32
220	22	M	100KHz, 1.0V	0.128	1.2
270	27	M	100KHz, 1.0V	0.142	1.05
330	33	M	100KHz, 1.0V	0.165	0.97
390	39	M	100KHz, 1.0V	0.21	0.86
470	47	M	100KHz, 1.0V	0.238	0.8
560	56	M	100KHz, 1.0V	0.277	0.73
680	68	M	100KHz, 1.0V	0.304	0.65
820	82	M	100KHz, 1.0V	0.39	0.6
101	100	M	100KHz, 1.0V	0.535	0.54

### 07D7

Codes	L (μH)	Tolerance	Test Condition	DCR (Ω) max.	IDC (A) max.
3R3	3.3	M	100KHz, 1.0V	0.02	3.5
5R0	5	M	100KHz, 1.0V	0.024	2.9
6R0	6	M	100KHz, 1.0V	0.027	2.5
7R3	7.3	M	100KHz, 1.0V	0.031	2.3
8R6	8.6	M	100KHz, 1.0V	0.034	2.2
100	10	M	100KHz, 1.0V	0.038	2
120	12	M	100KHz, 1.0V	0.053	1.7
150	15	M	100KHz, 1.0V	0.057	1.6
180	18	M	100KHz, 1.0V	0.092	1.5
220	22	M	100KHz, 1.0V	0.096	1.3
270	27	M	100KHz, 1.0V	0.109	1.2
330	33	M	100KHz, 1.0V	0.124	1.1
390	39	M	100KHz, 1.0V	0.138	1
470	47	M	100KHz, 1.0V	0.155	0.95
560	56	M	100KHz, 1.0V	0.202	0.85
680	68	M	100KHz, 1.0V	0.234	0.75
820	82	M	100KHz, 1.0V	0.324	0.7
101	100	M	100KHz, 1.0V	0.358	0.65

# LMax SMD Miniature Power Inductor

## LMMN Series – Miniature Style M

### FEATURES

- LMMN series miniature chip inductors are wound on a special ferrite core.
- 0302/ 03A2/ 0403 are high Q value at high frequency and low DC resistance.
- 0302/03A2/ 0403/ 0605 are low DC resistance, high current capacity, and high impedance characteristics. They are excellent for using as a choke coil in DC power supply circuits.
- Operating temperature range (0202, 02A2, 02B2, 0302): -40°C to 105°C
- Operating temperature range (03A2, 0403, 0605): -40°C to 85°C

### INDUCTANCE AND RATED CURRENT RANGES

- 0202 1.00 ~ 10μH 2.80 ~ 0.65A
- 02A2 1.00 ~ 10μH 3.70 ~ 0.90A
- 02B2 1.00 ~ 22μH 2.30 ~ 0.51A
- 0302 1.00 ~ 100μH 1.00 ~ 0.1A
- 03A2 1.00 ~ 560μH 0.445 ~ 0.04A
- 0403 1.00 ~ 2200μH 0.50 ~ 0.03A
- 0302 (C) 0.47 ~ 120μH 3.40 ~ 0.17A
- 03A2 (C) 1.00 ~ 560μH 1.00 ~ 0.06A
- 0403 (C) 1.00 ~ 470μH 1.08 ~ 0.09A
- 0605 (C) 0.12 ~ 10000μH 6.00 ~ 0.05A
- Electrical specifications at 25°C



### APPLICATIONS

- High Frequency Communication Products
- Personal Computers
- Disk Drives And Computer Peripherals
- DC Power Supply Circuits

### DIMENSIONS

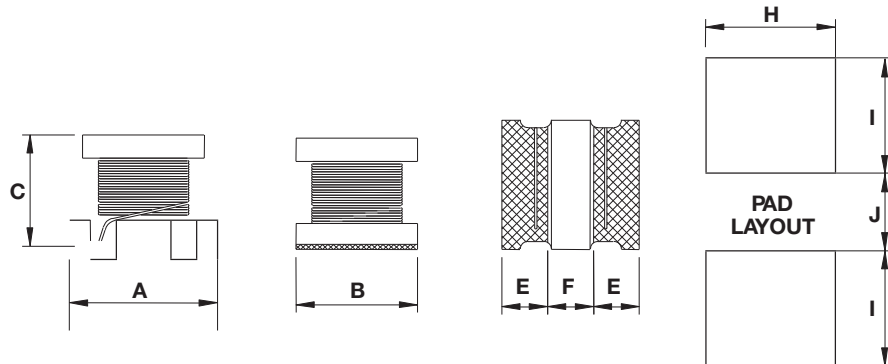

mm (inches)

Type	A	B	C	E	F	H	I	J
0202	2.50 ± 0.20 (0.098 ± 0.008)	2.00 ± 0.20 (0.079 ± 0.008)	1.00 max. (0.039)	0.40 ± 0.20 (0.016 ± 0.008)	1.00 min. (0.039)	2.10 (0.083)	0.90 (0.035)	0.80 (0.031)
02A2	2.50 ± 0.20 (0.098 ± 0.008)	2.00 ± 0.20 (0.079 ± 0.008)	1.25 max. (0.049)	0.40 ± 0.20 (0.016 ± 0.008)	1.00 min. (0.039)	2.10 (0.083)	0.90 (0.035)	0.80 (0.031)
02B2	2.50 ± 0.20 (0.098 ± 0.008)	2.50 ± 0.20 (0.098 ± 0.008)	1.05 max. (0.041)	0.85 ref (0.033)	0.85 ref (0.033)	2.50 (0.098)	1.20 (0.047)	0.80 (0.031)
0302 / 0302 (C)	3.20 ± 0.30 (0.126 ± 0.012)	2.50 ± 0.20 (0.098 ± 0.008)	1.55 ± 0.30 (0.061 ± 0.012)	1.05 ± 0.30 (0.041 ± 0.012)	1.05 ± 0.30 (0.041 ± 0.012)	2.00 (0.079)	1.50 (0.059)	1.00 (0.039)
03A2 / 03A2 (C)	3.20 ± 0.30 (0.126 ± 0.012)	2.50 ± 0.20 (0.098 ± 0.008)	2.00 ± 0.30 (0.079 ± 0.012)	1.05 ± 0.30 (0.041 ± 0.012)	1.05 ± 0.30 (0.041 ± 0.012)	2.00 (0.079)	1.50 (0.059)	1.00 (0.039)
0403 / 0403 (C)	4.50 ± 0.30 (0.177 ± 0.012)	3.20 ± 0.20 (0.126 ± 0.008)	2.60 ± 0.30 (0.102 ± 0.012)	1.00 min. (0.039)	1.00 min. (0.039)	3.00 (0.118)	2.00 (0.079)	1.20 (0.047)
0605 (C)	5.70 ± 0.30 (0.224 ± 0.012)	5.00 ± 0.30 (0.197 ± 0.012)	4.70 ± 0.50 (0.185 ± 0.020)	1.30 min. (0.051)	1.70 min. (0.067)	5.00 (0.197)	2.00 (0.079)	2.00 (0.079)

# LMax SMD Power Inductor

## LMMN Series – Miniature Style M

### HOW TO ORDER

<b>LM</b>	<b>MN</b>	<b>0202</b>	<b>N</b>	<b>R04</b>	<b>M</b>	<b>T</b>	<b>A</b>	<b>R</b>
Family	Series	Size	Tolerance	Inductance	Style	Termination	Special	Packaging
LM = Power Inductor	MN = Miniature	0202 = 2x2xh (h = see catalog)	J = ±5% K = ±10% M = ±20% N = ±30%	R39 = 0.390µH 3R9 = 3.900µH 390 = 39.00µH 391 = 390.0µH 392 = 3900µH		T = Sn Plate	A = Standard C = Choke*	R = 7" Reel S = 13" Reel*
							*Available for 0302, 03A2, 0402 and 0605 sizes only	*0605 size only

### ELECTRICAL CHARACTERISTICS

#### 0202

AVX PN	L (µH)	Tolerance	Test Condition	DCR (Ω) max.	I <sub>RMS</sub> <sup>1</sup> (A) Typical	I <sub>SAT</sub> <sup>2</sup> (A) Typical
LMMN0202M1R0MTAR	1.0	M	1MHz, 0.1V	0.085	1.7	2
LMMN0202M1R5MTAR	1.5	M	1MHz, 0.1V	0.128	1.4	1.7
LMMN0202M2R2MTAR	2.2	M	1MHz, 0.1V	0.19	1.1	1.4
LMMN0202M3R3MTAR	3.3	M	1MHz, 0.1V	0.304	0.94	1.2
LMMN0202M4R7MTAR	4.7	M	1MHz, 0.1V	0.44	0.78	0.98
LMMN0202M6R8MTAR	6.8	M	1MHz, 0.1V	0.541	0.7	0.82
LMMN0202M100MTAR	10	M	1MHz, 0.1V	0.854	0.52	0.65

<sup>1</sup> The temperature rise current value (I<sub>RMS</sub>) is the DC current value that increases component temperature by up to 40°C. (Ta=25°C)

<sup>2</sup> The saturation current value (I<sub>SAT</sub>) is the DC current value when the inductance decreases by 30% of its initial value. (Ta=25°C)

#### 02A2

AVX PN	L (µH)	Tolerance	Test Condition	DCR (Ω) max.	I <sub>RMS</sub> <sup>1</sup> (A) Typical	I <sub>SAT</sub> <sup>2</sup> (A) Typical
LMMN02A2M1R0MTAR	1.0	M	1MHz, 0.1V	0.088	1.8	2.7
LMMN02A2M1R5MTAR	1.5	M	1MHz, 0.1V	0.126	1.5	2.2
LMMN02A2M2R2MTAR	2.2	M	1MHz, 0.1V	0.155	1.3	2
LMMN02A2M3R3MTAR	3.3	M	1MHz, 0.1V	0.272	1	1.6
LMMN02A2M4R7MTAR	4.7	M	1MHz, 0.1V	0.45	0.81	1.2
LMMN02A2M5R6MTAR	5.6	M	1MHz, 0.1V	0.45	0.72	1.15
LMMN02A2M6R8MTAR	6.8	M	1MHz, 0.1V	0.612	0.66	1.1
LMMN02A2M100MTAR	10	M	1MHz, 0.1V	0.756	0.59	0.9

<sup>1</sup> The temperature rise current value (I<sub>RMS</sub>) is the DC current value that increases component temperature by up to 40°C. (Ta=25°C)

<sup>2</sup> The saturation current value (I<sub>SAT</sub>) is the DC current value when the inductance decreases by 30% of its initial value. (Ta=25°C)

#### 02B2

AVX PN	L (µH)	Tolerance	Test Condition	DCR (Ω) max.	I <sub>RMS</sub> <sup>1</sup> (A) Typical	I <sub>SAT</sub> <sup>2</sup> (A) Typical
LMMN02B2M1R0MTAR	1.0	M	1MHz, 0.1V	0.085	1.9	2.3
LMMN02B2M1R5MTAR	1.5	M	1MHz, 0.1V	0.115	1.5	1.9
LMMN02B2M2R2MTAR	2.2	M	1MHz, 0.1V	0.168	1.2	1.5
LMMN02B2M3R3MTAR	3.3	M	1MHz, 0.1V	0.239	1.1	1.3
LMMN02B2M4R7MTAR	4.7	M	1MHz, 0.1V	0.316	0.9	1.1
LMMN02B2M5R6MTAR	5.6	M	1MHz, 0.1V	0.42	0.83	0.98
LMMN02B2M6R8MTAR	6.8	M	1MHz, 0.1V	0.487	0.8	0.9
LMMN02B2M8R2MTAR	8.2	M	1MHz, 0.1V	0.548	0.71	0.84
LMMN02B2M100MTAR	10	M	1MHz, 0.1V	0.61	0.68	0.79
LMMN02B2M220MTAR	22	M	1MHz, 0.1V	1.552	0.4	0.51

<sup>1</sup> The temperature rise current value (I<sub>RMS</sub>) is the DC current value that increases component temperature by up to 40°C. (Ta=25°C)

<sup>2</sup> The saturation current value (I<sub>SAT</sub>) is the DC current value when the inductance decreases by 30% of its initial value. (Ta=25°C)

# LMax SMD Power Inductor

## LMMN Series – Miniature Style M

### 0302

AVX PN	L (μH)	Tolerance	Test Condition	DCR (Ω) max.	I <sub>dc</sub> <sup>1</sup> (A) Typical	SRF (MHz) min
LMMN0302N1R0MTAR	1.0	N	1MHz, 0.1V	0.078	1	100
LMMN0302N1R5MTAR	1.5	N	1MHz, 0.1V	0.068	1.2	100
LMMN0302M2R2MTAR	2.2	M	1MHz, 0.1V	0.126	0.79	64
LMMN0302M3R3MTAR	3.3	M	1MHz, 0.1V	0.18	0.7	50
LMMN0302M4R7MTAR	4.7	M	1MHz, 0.1V	0.195	0.65	43
LMMN0302K100MTAR	10	K	1MHz, 0.1V	0.42	0.45	26
LMMN0302K150MTAR	15	K	1MHz, 0.1V	0.75	0.3	22
LMMN0302K220MTAR	22	K	1MHz, 0.1V	1	0.25	19
LMMN0302K330MTAR	33	K	1MHz, 0.1V	1.4	0.2	17
LMMN0302K470MTAR	47	K	1MHz, 0.1V	2.2	0.17	13
LMMN0302K680MTAR	68	K	1MHz, 0.1V	3.2	0.13	9
LMMN0302K101MTAR	100	K	1MHz, 0.1V	4.5	0.1	8

<sup>1</sup>I<sub>dc</sub>: The current when the inductance becomes 10% lower than its initial value or the current when the temperature of the coil increases by 20°C.  
The smaller one is defined as the rated DC current. (Ta=25°C)

\* Inductance Tolerance: J=±5%, K=±10%, M=±20%

### 0403

AVX PN	L (μH)	Tolerance	Test Condition	Quality Factor		DCR (Ω) max.	I <sub>dc</sub> <sup>1</sup> (A) Typical	SRF (MHz) min
				Q	Test Condition			
LMMN03A2M1R0MTAR	1.0	M	1MHz, 0.1V	20	1MHz, 0.1V	0.5	0.445	100
LMMN03A2M1R2MTAR	1.2	M	1MHz, 0.1V	20	1MHz, 0.1V	0.6	0.425	100
LMMN03A2*1R5MTAR	1.5	K, M	1MHz, 0.1V	20	1MHz, 0.1V	0.6	0.4	75
LMMN03A2*1R8MTAR	1.8	K, M	1MHz, 0.1V	20	1MHz, 0.1V	0.7	0.39	60
LMMN03A2*2R2MTAR	2.2	K, M	1MHz, 0.1V	20	1MHz, 0.1V	0.8	0.37	50
LMMN03A2*2R7MTAR	2.7	K, M	1MHz, 0.1V	20	1MHz, 0.1V	0.9	0.32	43
LMMN03A2*3R3MTAR	3.3	K, M	1MHz, 0.1V	20	1MHz, 0.1V	1	0.3	38
LMMN03A2*3R9MTAR	3.9	K, M	1MHz, 0.1V	20	1MHz, 0.1V	1.1	0.29	35
LMMN03A2*4R7MTAR	4.7	K, M	1MHz, 0.1V	20	1MHz, 0.1V	1.2	0.27	31
LMMN03A2*5R6MTAR	5.6	K, M	1MHz, 0.1V	20	1MHz, 0.1V	1.3	0.25	28
LMMN03A2*6R8MTAR	6.8	K, M	1MHz, 0.1V	20	1MHz, 0.1V	1.5	0.24	25
LMMN03A2*8R2MTAR	8.2	K, M	1MHz, 0.1V	20	1MHz, 0.1V	1.6	0.225	23
LMMN03A2*100MTAR	10	J, K	1MHz, 0.1V	35	1MHz, 0.1V	1.8	0.19	20
LMMN03A2*120MTAR	12	J, K	1MHz, 0.1V	35	1MHz, 0.1V	2	0.18	18
LMMN03A2*150MTAR	15	J, K	1MHz, 0.1V	35	1MHz, 0.1V	2.2	0.17	16
LMMN03A2*180MTAR	18	J, K	1MHz, 0.1V	35	1MHz, 0.1V	2.5	0.165	15
LMMN03A2*220MTAR	22	J, K	1MHz, 0.1V	35	1MHz, 0.1V	2.8	0.15	14
LMMN03A2*270MTAR	27	J, K	1MHz, 0.1V	35	1MHz, 0.1V	3.1	0.125	13
LMMN03A2*330MTAR	33	J, K	1MHz, 0.1V	40	1MHz, 0.1V	3.5	0.115	12
LMMN03A2*390MTAR	39	J, K	1MHz, 0.1V	40	1MHz, 0.1V	3.9	0.11	11
LMMN03A2*470MTAR	47	J, K	1MHz, 0.1V	40	1MHz, 0.1V	4.3	0.1	11
LMMN03A2*560MTAR	56	J, K	1MHz, 0.1V	40	1MHz, 0.1V	4.9	0.085	10
LMMN03A2*680MTAR	68	J, K	1MHz, 0.1V	40	1MHz, 0.1V	5.5	0.08	9
LMMN03A2*820MTAR	82	J, K	1MHz, 0.1V	40	1MHz, 0.1V	6.2	0.07	8.5
LMMN03A2*101MTAR	100	J, K	1MHz, 0.1V	40	796KHz, 0.1V	7	0.08	8
LMMN03A2*121MTAR	120	J, K	1MHz, 0.1V	40	796KHz, 0.1V	8	0.075	7.5
LMMN03A2*151MTAR	150	J, K	1MHz, 0.1V	40	796KHz, 0.1V	9.3	0.07	7
LMMN03A2*181MTAR	180	J, K	1MHz, 0.1V	40	796KHz, 0.1V	10.2	0.065	6
LMMN03A2*221MTAR	220	J, K	1MHz, 0.1V	40	796KHz, 0.1V	11.8	0.065	5.5
LMMN03A2*271MTAR	270	J, K	1MHz, 0.1V	40	796KHz, 0.1V	12.5	0.065	5
LMMN03A2*331MTAR	330	J, K	1MHz, 0.1V	40	796KHz, 0.1V	15	0.065	5
LMMN03A2*391MTAR	390	J, K	1MHz, 0.1V	50	796KHz, 0.1V	22	0.05	5
LMMN03A2*471MTAR	470	J, K	1KHz, 0.1V	50	796KHz, 0.1V	25	0.045	5
LMMN03A2*561MTAR	560	J, K	1KHz, 0.1V	50	796KHz, 0.1V	28	0.04	5 ref

<sup>1</sup>I<sub>dc</sub>: The current when the inductance becomes 10% lower than its initial value or the current when the temperature of the coil increases by 20°C.  
The smaller one is defined as the rated DC current. (Ta=25°C)

\* Inductance Tolerance: J=±5%, K=±10%, M=±20%

# LMax SMD Power Inductor

## LMMN Series – Miniature Style M

### 0403

AVX PN	L ( $\mu$ H)	Tolerance	Test Condition	Quality Factor		DCR ( $\Omega$ ) max.	$I_{dc}^1$ (A) Typical	SRF (MHz) min
				SPEC	Test Condition			
LMMN0403M1R0MTAR	1.0	M	1MHz, 0.1V	20	1MHz, 0.1V	0.2	0.5	120
LMMN0403M1R2MTAR	1.2	M	1MHz, 0.1V	20	1MHz, 0.1V	0.2	0.5	100
LMMN0403M1R5MTAR	1.5	M	1MHz, 0.1V	20	1MHz, 0.1V	0.3	0.5	85
LMMN0403M1R8MTAR	1.8	M	1MHz, 0.1V	20	1MHz, 0.1V	0.3	0.5	75
LMMN0403M2R2MTAR	2.2	M	1MHz, 0.1V	20	1MHz, 0.1V	0.3	0.5	62
LMMN0403M2R7MTAR	2.7	M	1MHz, 0.1V	20	1MHz, 0.1V	0.32	0.5	53
LMMN0403M3R3MTAR	3.3	M	1MHz, 0.1V	20	1MHz, 0.1V	0.35	0.5	47
LMMN0403M3R9MTAR	3.9	M	1MHz, 0.1V	20	1MHz, 0.1V	0.38	0.5	41
LMMN0403*4R7MTAR	4.7	K, M	1MHz, 0.1V	30	1MHz, 0.1V	0.4	0.5	38
LMMN0403*5R6MTAR	5.6	K, M	1MHz, 0.1V	30	1MHz, 0.1V	0.47	0.5	33
LMMN0403*6R8MTAR	6.8	K, M	1MHz, 0.1V	30	1MHz, 0.1V	0.5	0.45	31
LMMN0403*8R2MTAR	8.2	K, M	1MHz, 0.1V	30	1MHz, 0.1V	0.56	0.45	27
LMMN0403*100MTAR	10	J, K	1MHz, 0.1V	35	1MHz, 0.1V	0.56	0.4	23
LMMN0403*120MTAR	12	J, K	1MHz, 0.1V	35	1MHz, 0.1V	0.62	0.38	21
LMMN0403*150MTAR	15	J, K	1MHz, 0.1V	35	1MHz, 0.1V	0.73	0.36	19
LMMN0403*180MTAR	18	J, K	1MHz, 0.1V	35	1MHz, 0.1V	0.82	0.34	17
LMMN0403*220MTAR	22	J, K	1MHz, 0.1V	35	1MHz, 0.1V	0.94	0.32	15
LMMN0403*270MTAR	27	J, K	1MHz, 0.1V	35	1MHz, 0.1V	1.1	0.3	14
LMMN0403*330MTAR	33	J, K	1MHz, 0.1V	35	1MHz, 0.1V	1.2	0.27	12
LMMN0403*390MTAR	39	J, K	1MHz, 0.1V	35	1MHz, 0.1V	1.4	0.24	11
LMMN0403*470MTAR	47	J, K	1MHz, 0.1V	35	1MHz, 0.1V	1.5	0.22	10
LMMN0403*560MTAR	56	J, K	1MHz, 0.1V	35	1MHz, 0.1V	1.7	0.2	9.3
LMMN0403*680MTAR	68	J, K	1MHz, 0.1V	35	1MHz, 0.1V	1.9	0.18	8.4
LMMN0403*820MTAR	82	J, K	1MHz, 0.1V	35	1MHz, 0.1V	2.2	0.17	7.5
LMMN0403*101MTAR	100	J, K	1MHz, 0.1V	40	796KHz, 0.1V	2.5	0.16	6.8
LMMN0403*121MTAR	120	J, K	1MHz, 0.1V	40	796KHz, 0.1V	3	0.15	6.2
LMMN0403*151MTAR	150	J, K	1MHz, 0.1V	40	796KHz, 0.1V	3.7	0.13	5.5
LMMN0403*181MTAR	180	J, K	1MHz, 0.1V	40	796KHz, 0.1V	4.5	0.12	5
LMMN0403*221MTAR	220	J, K	1MHz, 0.1V	40	796KHz, 0.1V	5.4	0.11	4.5
LMMN0403*271MTAR	270	J, K	1MHz, 0.1V	40	796KHz, 0.1V	6.8	0.1	4
LMMN0403*331MTAR	330	J, K	1MHz, 0.1V	40	796KHz, 0.1V	8.2	0.095	3.6
LMMN0403*391MTAR	390	J, K	1MHz, 0.1V	40	796KHz, 0.1V	9.7	0.09	3.3
LMMN0403*471MTAR	470	J, K	1KHz, 0.1V	40	796KHz, 0.1V	11.8	0.08	3
LMMN0403*561MTAR	560	J, K	1KHz, 0.1V	40	796KHz, 0.1V	14.5	0.07	2.7
LMMN0403*681MTAR	680	J, K	1KHz, 0.1V	40	796KHz, 0.1V	17	0.065	2.5
LMMN0403*821MTAR	820	J, K	1KHz, 0.1V	40	796KHz, 0.1V	20.5	0.06	2.2
LMMN0403*102MTAR	1000	J, K	1KHz, 0.1V	40	252KHz, 0.1V	25	0.05	2
LMMN0403*122MTAR	1200	J, K	1KHz, 0.1V	40	252KHz, 0.1V	30	0.045	1.8
LMMN0403*152MTAR	1500	J, K	1KHz, 0.1V	40	252KHz, 0.1V	37	0.04	1.6
LMMN0403*182MTAR	1800	J, K	1KHz, 0.1V	40	252KHz, 0.1V	45	0.035	1.5
LMMN0403*222MTAR	2200	J, K	1KHz, 0.1V	40	252KHz, 0.1V	50	0.03	1.3

<sup>1</sup> $I_{dc}$ : The current when the inductance becomes 10% lower than its initial value or the current when the temperature of the coil increases by 20°C.  
The smaller one is defined as the rated DC current. (Ta=25°C)

\* Inductance Tolerance: J=±5%, K=±10%, M=±20%

# LMax SMD Power Inductor

## LMMN Series – Miniature Style M

### 0302 (C)

AVX PN	L (μH)	Tolerance	Test Condition	DCR (Ω) max.	I <sub>RMS</sub> <sup>1</sup> (A) Typ.	I <sub>SAT</sub> <sup>2</sup> (A) Typ.	SRF (MHz) min
LMMN0302NR47MTCR	0.47	N	1MHz, 0.1V	0.03	2.55	3.4	100
LMMN0302N1R0MTCR	1.0	N	1MHz, 0.1V	0.045	2.05	2.3	100
LMMN0302N1R5MTCR	1.5	N	1MHz, 0.1V	0.057	1.75	1.75	70
LMMN0302N2R2MTCR	2.2	N	1MHz, 0.1V	0.076	1.6	1.55	70
LMMN0302N3R3MTCR	3.3	N	1MHz, 0.1V	0.12	1.2	1.25	50
LMMN0302N4R7MTCR	4.7	N	1MHz, 0.1V	0.18	1	1	40
LMMN0302N6R8MTCR	6.8	N	1MHz, 0.1V	0.24	0.85	0.85	40
LMMN0302M100MTCR	10	M	1MHz, 0.1V	0.38	0.7	0.75	30
LMMN0302M150MTCR	15	M	1MHz, 0.1V	0.57	0.52	0.6	20
LMMN0302M220MTCR	22	M	1MHz, 0.1V	0.81	0.45	0.5	20
LMMN0302M330MTCR	33	M	1MHz, 0.1V	1.15	0.39	0.38	13
LMMN0302M470MTCR	47	M	1MHz, 0.1V	1.78	0.31	0.33	11
LMMN0302M680MTCR	68	M	1MHz, 0.1V	2.28	0.275	0.28	11
LMMN0302M101MTCR	100	M	1MHz, 0.1V	2.7	0.25	0.18	8
LMMN0302M121MTCR	120	M	1MHz, 0.1V	4.38	0.2	0.17	8

<sup>1</sup> The temperature rise current value (IRMS) is the DC current value that increases component temperature by up to 40°C. (Ta=25°C)

<sup>2</sup> The saturation current value (ISAT) is the DC current value when the inductance decreases by 30% of its initial value. (Ta=25°C)

### 03A2 (C)

AVX PN	L (μH)	Tolerance	Test Condition	DCR (Ω) max.	I <sub>DC</sub> <sup>1</sup> (A) Typical	SRF (MHz) min
LMMN03A2M1R0MTCR	1.0	M	1MHz, 0.1V	0.078	1	100
LMMN03A2M2R2MTCR	2.2	M	1MHz, 0.1V	0.126	0.79	64
LMMN03A2M3R3MTCR	3.3	M	1MHz, 0.1V	0.165	0.5	50
LMMN03A2M4R7MTCR	4.7	M	1MHz, 0.1V	0.195	0.45	43
LMMN03A2M6R8MTCR	6.8	M	1MHz, 0.1V	0.33	0.45	38
LMMN03A2M100MTCR	10	M	1MHz, 0.1V	0.572	0.3	26
LMMN03A2*220MTCR	22	K, M	1MHz, 0.1V	0.923	0.25	19
LMMN03A2*470MTCR	47	K, M	1MHz, 0.1V	1.69	0.17	12
LMMN03A2*101MTCR	100	J, K	1MHz, 0.1V	4.55	0.1	8
LMMN03A2*151MTCR	150	J, K	1MHz, 0.1V	9.1	0.08	7
LMMN03A2*221MTCR	220	J, K	1MHz, 0.1V	10.92	0.07	5.5
LMMN03A2*331MTCR	330	J, K	1MHz, 0.1V	13	0.06	4.5
LMMN03A2*391MTCR	390	J, K	1MHz, 0.1V	22.1	0.06	4
LMMN03A2*471MTCR	470	J, K	1MHz, 0.1V	24.7	0.06	3.7
LMMN03A2*561MTCR	560	J, K	1MHz, 0.1V	28.6	0.06	3.4

<sup>1</sup>I<sub>DC</sub>: The current when the inductance becomes 10% lower than its initial value or the current when the temperature of the coil increases by 20°C.

The smaller one is defined as the rated DC current. (Ta=25°C)

\* Inductance Tolerance: J=±5%, K=±10%, M=±20%



# LMax SMD Power Inductor

## LMMN Series – Miniature Style M

### 0403 (C)

AVX PN	L (μH)	Tolerance	Test Condition	DCR (Ω) max.	I <sub>dc</sub> <sup>1</sup> (A) Typical	SRF (MHz) min
LMMN0403M1R0MTCR	1.0	M	1MHz, 0.1V	0.08	1.08	100
LMMN0403M1R5MTCR	1.5	M	1MHz, 0.1V	0.09	1	85
LMMN0403M2R2MTCR	2.2	M	1MHz, 0.1V	0.11	0.9	60
LMMN0403M3R3MTCR	3.3	M	1MHz, 0.1V	0.13	0.8	47
LMMN0403*4R7MTCR	4.7	K, M	1MHz, 0.1V	0.15	0.75	35
LMMN0403*6R8MTCR	6.8	K, M	1MHz, 0.1V	0.2	0.72	30
LMMN0403*100MTCR	10	J, K	1MHz, 0.1V	0.24	0.65	23
LMMN0403*150MTCR	15	J, K	1MHz, 0.1V	0.32	0.57	20
LMMN0403*220MTCR	22	J, K	1MHz, 0.1V	0.6	0.42	15
LMMN0403*330MTCR	33	J, K	1MHz, 0.1V	1	0.31	12
LMMN0403*470MTCR	47	J, K	1MHz, 0.1V	1.1	0.28	10
LMMN0403*680MTCR	68	J, K	1MHz, 0.1V	1.7	0.22	8.4
LMMN0403*101MTCR	100	J, K	1MHz, 0.1V	2.2	0.19	6.8
LMMN0403*151MTCR	150	J, K	1MHz, 0.1V	3.5	0.13	5.5
LMMN0403*221MTCR	220	J, K	1MHz, 0.1V	4	0.11	4.5
LMMN0403*331MTCR	330	J, K	1MHz, 0.1V	6.8	0.1	3.6
LMMN0403*471MTCR	470	J, K	1MHz, 0.1V	8.5	0.09	3

<sup>1</sup>I<sub>dc</sub>: The current when the inductance becomes 10% lower than its initial value or the current when the temperature of the coil increases by 20°C.  
The smaller one is defined as the rated DC current. (Ta=25°C)

\* Inductance Tolerance: J=±5%, K=±10%, M=±20%

### 0605 (C)

AVX PN	L (μH)	Tolerance	Test Condition	DCR (Ω) max.	I <sub>dc</sub> <sup>1</sup> (A) Typical	SRF (MHz) min
LMMN0605MR12MTCS	0.12	M	1MHz, 0.1V	0.0098	6	450
LMMN0605MR27MTCS	0.27	M	1MHz, 0.1V	0.014	5.3	300
LMMN0605MR47MTCS	0.47	M	1MHz, 0.1V	0.0182	4.8	200
LMMN0605M1R0MTCR	1.0	M	1MHz, 0.1V	0.027	4	150
LMMN0605M1R5MTCR	1.5	M	1MHz, 0.1V	0.031	3.7	110
LMMN0605M2R2MTCR	2.2	M	1MHz, 0.1V	0.041	3.2	80
LMMN0605M3R3MTCR	3.3	M	1MHz, 0.1V	0.05	2.9	40
LMMN0605M4R7MTCR	4.7	M	1MHz, 0.1V	0.0574	2.7	30
LMMN0605M6R8MTCR	6.8	M	1MHz, 0.1V	0.104	2	25
LMMN0605*100MTCR	10	K, M	1MHz, 0.1V	0.13	1.7	20
LMMN0605*150MTCR	15	K, M	1MHz, 0.1V	0.21	1.4	17
LMMN0605*220MTCR	22	K, M	1MHz, 0.1V	0.266	1.2	15
LMMN0605*330MTCR	33	K, M	1MHz, 0.1V	0.448	0.9	12
LMMN0605*470MTCR	47	K, M	1MHz, 0.1V	0.56	0.8	10 ref
LMMN0605*680MTCR	68	K, M	1MHz, 0.1V	0.938	0.64	7.6
LMMN0605*101MTCR	100	K, M	100KHz, 0.1V	1.204	0.56	6.5
LMMN0605*151MTCR	150	K, M	100KHz, 0.1V	2.66	0.42	5
LMMN0605*221MTCR	220	K, M	100KHz, 0.1V	3.36	0.32	4
LMMN0605*331MTCR	330	K, M	100KHz, 0.1V	6.16	0.27	3.1
LMMN0605*471MTCR	470	K, M	100KHz, 0.1V	7.56	0.24	2.4
LMMN0605*681MTCR	680	K, M	100KHz, 0.1V	11.34	0.19	1.9
LMMN0605*102MTCR	1000	K, M	10KHz, 0.1V	14.42	0.15	1.7
LMMN0605*222MTCR	2200	K, M	10KHz, 0.1V	30.1	0.1	1.2
LMMN0605*472MTCR	4700	K, M	10KHz, 0.1V	61.04	0.07	0.8
LMMN0605*103MTCR	10000	K, M	10KHz, 0.1V	140	0.05	0.5

<sup>1</sup>I<sub>dc</sub>: The current when the inductance becomes 10% lower than its initial value or the current when the temperature of the coil increases by 20°C.  
The smaller one is defined as the rated DC current. (Ta=25°C)

\* Inductance Tolerance: J=±5%, K=±10%, M=±20%

# LMax SMD Power Inductor

## LMMN Series – Miniature Style M

### SHELF STORAGE SPECIFICATIONS

Items	Specifications
Shelf Storage Conditions	Temperature range: 25±3°C • Humidity: <80% relative humidity. Recommendation: Product should be used within six months from the time of delivery.

### ENVIRONMENTAL SPECIFICATIONS

Items	Specification	Test Method/Conditions
High Temperature Storage Test	No case deformation or change in appearance $\Delta L/L \leq 10\%$ $\Delta Q/Q \leq 30\%$	Temperature: 85±2°C Time: 48±2 hours Tested after 1 hour at room temperature.
Low Temperature Storage Test		Temperature: -25±2°C Time: 48±2 hours Tested after 1 hour at room temperature.
Humidity Test		Temperature: 40±2°C, 90~95% relative humidity Time: 96±2 hours Tested after 1 hour at room temperature.
Thermal Shock Test		1 Cycle: -25°C for 30 minutes +25°C for 10 minutes 85°C for 30 minutes Go through 5 cycles. Tested after 1 hour at room temperature.

### MECHANICAL SPECIFICATIONS

Items	Specification	Test Method/Conditions
Solderability Test	Terminal area must have 90% minimum solder coverage	Lead-free termination: Dip pads in flux then dip in solder pot at 245±5°C for 3 seconds.
Resistance to solder heat	No case deformation or change in appearance.	Flux should cover the whole of the sample before heating, then be preheated for about 2 minutes over temperature 130 – 150°C. Immersing to 260±5°C for 10 seconds.
Vibration Test	No case deformation or change in appearance $\Delta L/L \leq 10\%$ $\Delta Q/Q \leq 30\%$	Apply frequency at 10 – 55 Hz. 1.5mm amplitude in each of perpendicular direction for 2 hours.
Shock Resistance		Drop down with 981m/s <sup>2</sup> (100G) shock attitude upon a rubber block method shock testing machine – 1 time. In each three orientations.

### RELOW SOLDERING RECOMMENDATION

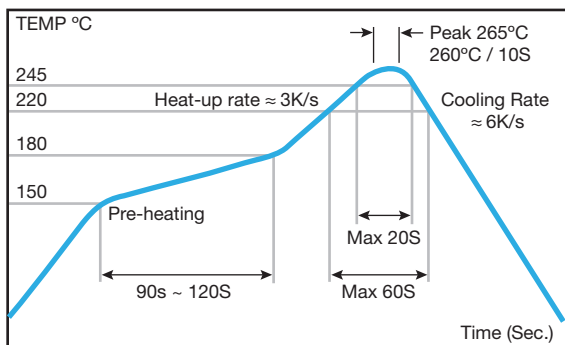

# LMax SMD Power Inductor

## LMMN Series – Miniature Style M

### PACKAGING SPECIFICATIONS

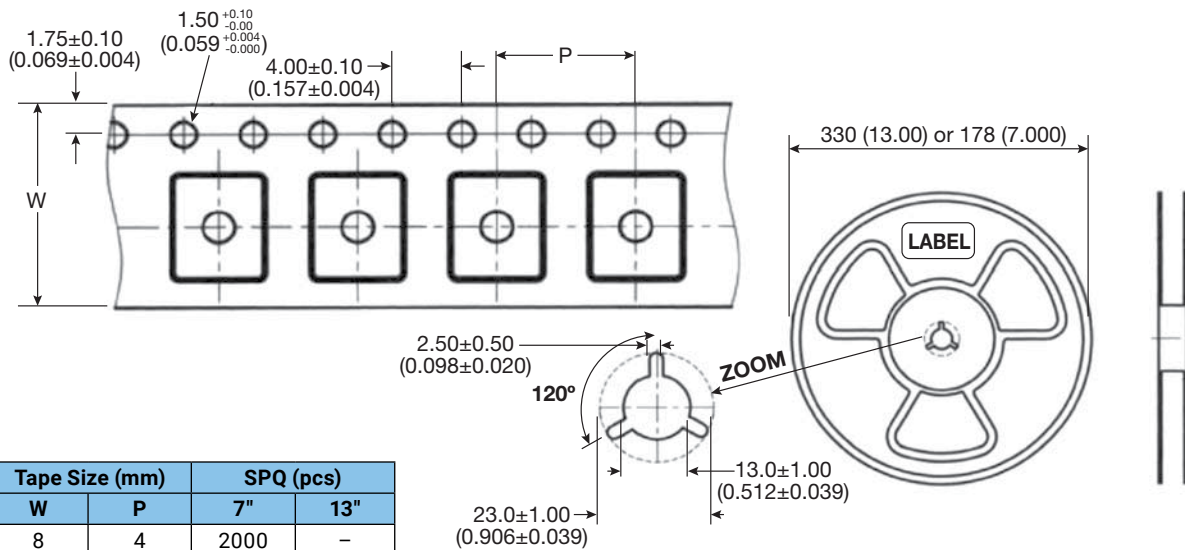
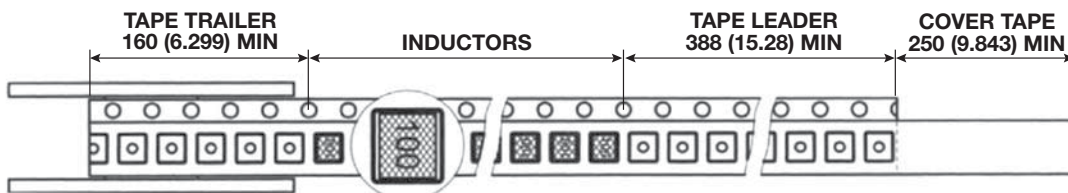
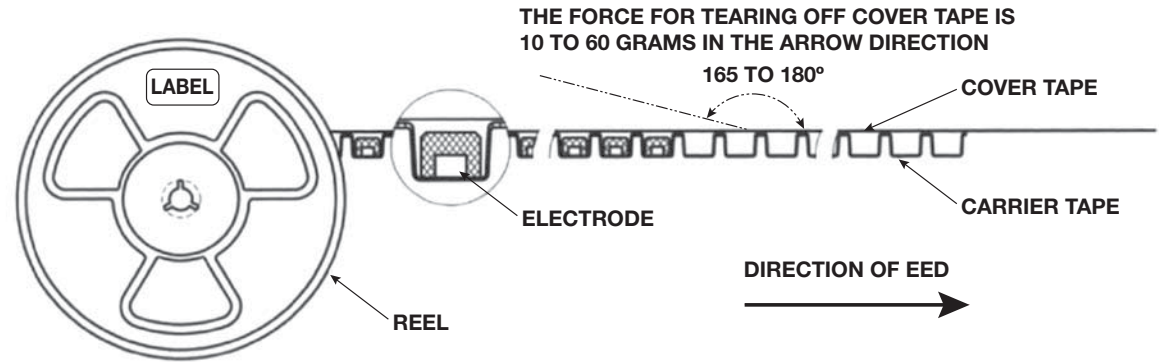

Size Code	Tape Size (mm)		SPQ (pcs)	
	W	P	7"	13"
0202	8	4	2000	-
02A2	8	4	2000	-
02B2	8	4	2000	-
0302	8	4	2000	-
03A2	8	4	2000	-
0403	12	8	500	-
0605	16	12	-	1000

# LMax Low Profile Power Inductor

## LMLP Series – Style C

### FEATURES

- Small and low profile inductor
- It corresponds to high current
- Simple and original magnetic shield structure

### APPLICATIONS

- For small DC/DC converter (cellular phone, HDD, DVC, DSC, PDA, LCD display etc.)

### CHARACTERISTICS

- Operating Temperature Range: -40°C to +125°C
- Storage Temperature Range: -40°C to +85°C
- Saturation Current: The saturation current value (ISAT) is the DC current value when the inductance decreases by 30% of its initial value (at 20°C).
- Temperature Rise Current: The temperature rise current value (IRMS) is the DC current value that increases component temperature by up to 40°C.

### INDUCTANCE AND RATED CURRENT RANGES

• 0202	2.2 ~ 22μH	1.290 ~ 0.390A
• 0303	1.0 ~ 22μH	1.30 ~ 0.350A
• 03A2	1.0 ~ 22μH	1.50 ~ 0.370A
• 03B3	1.0 ~ 22μH	2.10 ~ 0.470A
• 0404	1.0 ~ 22μH	1.80 ~ 0.360A
• 04A4	1.0 ~ 22μH	2.50 ~ 0.510A
• 04B4	1.0 ~ 220μH	4.0 ~ 0.270A
• 0505	10μH	1.00A
• 05B5	1.50 ~ 22.0μH	3.35 ~ 0.90A
• 05D5	1.50 ~ 47.0μH	6.00 ~ 1.10A
• 0606	4.7 ~ 10.0μH	1.40 ~ 1.00A
• 06A6	2.50 ~ 100μH	2.10 ~ 0.35A
• 06B6	0.80 ~ 22.0μH	5.50 ~ 1.05A
• 06C6	1.50 ~ 100μH	5.00 ~ 0.62A
• 06D6	1.30 ~ 100μH	8.00 ~ 0.80A
• 0808	0.90 ~ 22μH	11.0 ~ 2.2A



### DIMENSIONS

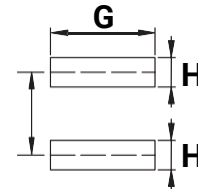
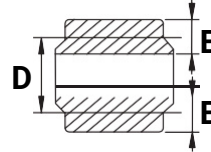
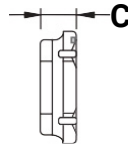
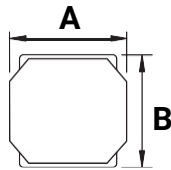

PCB Pattern

mm (inches)

Type	A	B	C max	D	E	F	G	H
0202	2.40 ± 0.10 (0.095 ± 0.004)	2.40 ± 0.10 (0.095 ± 0.004)	1.00 (0.039)	1.45 ± 0.20 (0.057 ± 0.008)	0.60 ± 0.20 (0.240 ± 0.008)	1.45 (0.057)	2.00 (0.079)	0.70 (0.028)
0303	3.00 ± 0.20 (0.118 ± 0.008)	3.00 ± 0.20 (0.118 ± 0.008)	1.00 (0.039)	1.90 ± 0.20 (0.075 ± 0.008)	0.90 ± 0.20 (0.035 ± 0.008)	2.20 (0.087)	2.70 (0.106)	0.80 (0.032)
03A2	3.00 ± 0.20 (0.118 ± 0.008)	3.00 ± 0.20 (0.118 ± 0.008)	1.20 (0.047)	1.90 ± 0.20 (0.075 ± 0.008)	0.90 ± 0.20 (0.035 ± 0.008)	2.20 (0.087)	2.70 (0.106)	0.80 (0.032)
03B3	3.00 ± 0.20 (0.118 ± 0.008)	3.00 ± 0.20 (0.118 ± 0.008)	1.50 (0.059)	1.90 ± 0.20 (0.075 ± 0.008)	0.90 ± 0.20 (0.035 ± 0.008)	2.20 (0.087)	2.70 (0.106)	0.80 (0.032)
0404	4.00 ± 0.20 (0.157 ± 0.008)	4.00 ± 0.20 (0.157 ± 0.008)	1.00 (0.039)	2.50 ± 0.20 (0.099 ± 0.008)	1.10 ± 0.20 (0.043 ± 0.008)	2.80 (0.110)	3.70 (0.146)	1.20 (0.047)
04A4	4.00 ± 0.20 (0.157 ± 0.008)	4.00 ± 0.20 (0.157 ± 0.008)	1.20 (0.047)	2.50 ± 0.20 (0.099 ± 0.008)	1.10 ± 0.20 (0.043 ± 0.008)	2.80 (0.110)	3.70 (0.146)	1.20 (0.047)
04B4	4.00 ± 0.20 (0.157 ± 0.008)	4.00 ± 0.20 (0.157 ± 0.008)	1.80 (0.071)	2.50 ± 0.20 (0.099 ± 0.008)	1.10 ± 0.20 (0.043 ± 0.008)	2.80 (0.110)	3.70 (0.146)	1.20 (0.047)
0505	5.00 ± 0.20 (0.197 ± 0.008)	5.00 ± 0.20 (0.197 ± 0.008)	1.00 (0.039)	3.50 ± 0.20 (0.138 ± 0.008)	1.50 ± 0.20 (0.059 ± 0.008)	3.80 (0.150)	4.70 (0.185)	1.60 (0.063)
05B5	5.00 ± 0.20 (0.197 ± 0.008)	5.00 ± 0.20 (0.197 ± 0.008)	2.00 (0.078)	3.50 ± 0.20 (0.138 ± 0.008)	1.50 ± 0.20 (0.059 ± 0.008)	3.80 (0.150)	4.70 (0.185)	1.60 (0.063)
05D5	5.00 ± 0.20 (0.197 ± 0.008)	5.00 ± 0.20 (0.197 ± 0.008)	4.00 (0.157)	3.50 ± 0.20 (0.138 ± 0.008)	1.50 ± 0.20 (0.059 ± 0.008)	3.80 (0.150)	4.70 (0.185)	1.60 (0.063)
0606	6.00 ± 0.20 (0.236 ± 0.008)	6.00 ± 0.20 (0.236 ± 0.008)	1.00 ± 0.10 (0.039 ± 0.004)	4.00 ± 0.20 (0.157 ± 0.008)	1.35 ± 0.20 (0.053 ± 0.008)	4.70 (0.185)	5.70 (0.224)	1.60 (0.063)
06A6	6.00 ± 0.20 (0.236 ± 0.008)	6.00 ± 0.20 (0.236 ± 0.008)	1.20 (0.047)	4.00 ± 0.20 (0.157 ± 0.008)	1.35 ± 0.20 (0.053 ± 0.008)	4.70 (0.185)	5.70 (0.224)	1.60 (0.063)
06B6	6.00 ± 0.20 (0.236 ± 0.008)	6.00 ± 0.20 (0.236 ± 0.008)	2.00 (0.078)	4.00 ± 0.20 (0.157 ± 0.008)	1.35 ± 0.20 (0.053 ± 0.008)	4.70 (0.185)	5.70 (0.224)	1.60 (0.063)
06C6	6.00 ± 0.20 (0.236 ± 0.008)	6.00 ± 0.20 (0.236 ± 0.008)	2.80 (0.110)	4.00 ± 0.20 (0.157 ± 0.008)	1.35 ± 0.20 (0.053 ± 0.008)	4.70 (0.185)	5.70 (0.224)	1.60 (0.063)
06D6	6.00 ± 0.20 (0.236 ± 0.008)	6.00 ± 0.20 (0.236 ± 0.008)	4.50 (0.177)	4.00 ± 0.20 (0.157 ± 0.008)	1.35 ± 0.20 (0.053 ± 0.008)	4.70 (0.185)	5.70 (0.224)	1.60 (0.063)
0808	8.00 ± 0.20 (0.315 ± 0.008)	8.00 ± 0.20 (0.315 ± 0.008)	4.20 (0.165)	5.60 ± 0.30 (0.220 ± 0.011)	1.60 ± 0.30 (0.063 ± 0.011)	5.60 (0.220)	7.50 (0.188)	1.80 (0.071)

# LMax Low Profile Power Inductor

## LMLP Series – Style C



### HOW TO ORDER

<b>LM</b>	<b>LP</b>	<b>0303</b>	<b>M</b>	<b>R04</b>	<b>C</b>	<b>T</b>	<b>A</b>	<b>S</b>
Family	Series	Size	Tolerance	Inductance	Style	Termination	Special	Packaging
LM = Power Inductor	LP = Low Profile	0303 = 3x3xh 03A3 = 3x3xA(h) (h = see catalog)	M = 20% N = 30%	R39 = 0.390μH 3R9 = 3.900μH 390 = 39.00μH 391 = 390.0μH		T = Sn Plate	A = Standard	R = 7" Reel S = 13" Reel

### ELECTRICAL CHARACTERISTICS

#### 0202

AVX PN	L (μH) at 100KHz 1.0V	Tolerance	I <sub>SAT</sub> * (A)	I <sub>RMS</sub> ** (A)	DCR ±20% (Ω)
LMLP0202N2R2CTAR	2.2	±30%	1.29	0.97	0.15
LMLP0202N3R3CTAR	3.3	±30%	1	0.77	0.22
LMLP0202N4R7CTAR	4.7	±30%	0.88	0.67	0.29
LMLP0202N6R8CTAR	6.8	±30%	0.75	0.57	0.41
LMLP0202M100CTAR	10	±20%	0.55	0.45	0.69
LMLP0202M150CTAR	15	±20%	0.47	0.37	1.02
LMLP0202M220CTAR	22	±20%	0.39	0.3	1.47

#### 0303

AVX PN	L (μH) at 100KHz 1.0V	Tolerance	I <sub>SAT</sub> * (A)	I <sub>RMS</sub> ** (A)	DCR ±20% (Ω)
LMLP0303N1R5CTAR	1.5	±30%	1.2	1.3	0.08
LMLP0303N2R2CTAR	2.2	±30%	1.1	1.1	0.095
LMLP0303N3R3CTAR	3.3	±30%	0.87	0.94	0.14
LMLP0303N4R7CTAR	4.7	±30%	0.75	0.78	0.19
LMLP0303N6R8CTAR	6.8	±30%	0.61	0.63	0.3
LMLP0303M100CTAR	10	±20%	0.5	0.51	0.45
LMLP0303M150CTAR	15	±20%	0.4	0.4	0.74
LMLP0303M220CTAR	22	±20%	0.35	0.35	1.03

#### 03A2

AVX PN	L (μH) at 100KHz 1.0V	Tolerance	I <sub>SAT</sub> * (A)	I <sub>RMS</sub> ** (A)	DCR ±20% (Ω)
LMLP03A2N1R0CTAR	1.0	±30%	1.5	1.49	0.05
LMLP03A2N1R5CTAR	1.5	±30%	1.36	1.4	0.06
LMLP03A2N2R2CTAR	2.2	±30%	1.1	1.2	0.08
LMLP03A2N3R3CTAR	3.3	±30%	0.91	1.05	0.1
LMLP03A2N4R7CTAR	4.7	±30%	0.77	0.98	0.13
LMLP03A2N6R8CTAR	6.8	±30%	0.67	0.74	0.19
LMLP03A2M100CTAR	10	±20%	0.54	0.63	0.29
LMLP03A2M150CTAR	15	±20%	0.44	0.485	0.45
LMLP03A2M220CTAR	22	±20%	0.37	0.42	0.63

\*The saturation current value (ISAT) is the DC current value when the inductance decreases by 30% of its initial value (at 20°C).

\*\*The temperature rise current value (IRMS) is the DC current value that increases component temperature by up to 40°C.

# LMax Low Profile Power Inductor

## LMLP Series – Style C

### 03B3

AVX PN	L (μH) at 100KHz 1.0V	Tolerance	I <sub>SAT</sub> * (A)	I <sub>RMS</sub> ** (A)	DCR ±20% (Ω)
LMLP03B3N1R0CTAR	1.0	±30%	2.1	2.1	0.03
LMLP03B3N1R5CTAR	1.5	±30%	1.8	1.82	0.04
LMLP03B3N2R2CTAR	2.2	±30%	1.48	1.5	0.06
LMLP03B3N3R3CTAR	3.3	±30%	1.21	1.23	0.08
LMLP03B3N4R7CTAR	4.7	±30%	1.02	1.04	0.12
LMLP03B3N6R8CTAR	6.8	±30%	0.87	0.88	0.16
LMLP03B3M100CTAR	10	±20%	0.7	0.71	0.23
LMLP03B3M150CTAR	15	±20%	0.56	0.56	0.36
LMLP03B3M220CTAR	22	±20%	0.47	0.47	0.52

### 0404

AVX PN	L (μH) at 100KHz 1.0V	Tolerance	I <sub>SAT</sub> * (A)	I <sub>RMS</sub> ** (A)	DCR ±20% (Ω)
LMLP0404N1R0CTAS	1.0	±30%	1.8	1.05	0.1
LMLP0404N2R2CTAS	2.2	±30%	1.15	0.89	0.15
LMLP0404N3R3CTAS	3.3	±30%	1.1	0.82	0.18
LMLP0404N4R7CTAS	4.7	±30%	0.9	0.75	0.21
LMLP0404N6R8CTAS	6.8	±30%	0.74	0.62	0.3
LMLP0404N100CTAS	10	±30%	0.56	0.6	0.38
LMLP0404M150CTAS	15	±20%	0.47	0.51	0.51
LMLP0404M220CTAS	22	±20%	0.36	0.4	0.87

### 04A4

AVX PN	L (μH) at 100KHz 1.0V	Tolerance	I <sub>SAT</sub> * (A)	I <sub>RMS</sub> ** (A)	DCR ±20% (Ω)
LMLP04A4N1R0CTAS	1.0	±30%	2.5	1.5	0.06
LMLP04A4N2R2CTAS	2.2	±30%	1.65	1.2	0.09
LMLP04A4N3R3CTAS	3.3	±30%	1.2	0.98	0.13
LMLP04A4N4R7CTAS	4.7	±30%	1.05	0.96	0.14
LMLP04A4N6R8CTAS	6.8	±30%	0.9	0.84	0.18
LMLP04A4M100CTAS	10	±20%	0.74	0.77	0.24
LMLP04A4M150CTAS	15	±20%	0.56	0.6	0.4
LMLP04A4M220CTAS	22	±20%	0.51	0.54	0.48

\*The saturation current value (ISAT) is the DC current value when the inductance decreases by 30% of its initial value (at 20°C).

\*\*The temperature rise current value (IRMS) is the DC current value that increases component temperature by up to 40°C.

# LMax Low Profile Power Inductor

## LMLP Series – Style C



### 04B4

AVX PN	L (μH) at 100KHz 1.0V	Tolerance	I <sub>SAT</sub> * (A)	I <sub>RMS</sub> ** (A)	DCR ±20% (Ω)
LMLP04B4N1R0CTAS	1.0	±30%	4	1.83	0.03
LMLP04B4N2R2CTAS	2.2	±30%	2.7	1.44	0.06
LMLP04B4N3R3CTAS	3.3	±30%	2	1.23	0.07
LMLP04B4N4R7CTAS	4.7	±30%	1.7	1.2	0.09
LMLP04B4N6R8CTAS	6.8	±30%	1.45	1.06	0.11
LMLP04B4M100CTAS	10	±20%	1.2	0.84	0.18
LMLP04B4M150CTAS	15	±20%	0.94	0.65	0.28
LMLP04B4M220CTAS	22	±20%	0.8	0.59	0.36
LMLP04B4M330CTAS	33	±20%	0.65	0.49	0.53
LMLP04B4M470CTAS	47	±20%	0.57	0.42	0.65
LMLP04B4M680CTAS	68	±20%	0.47	0.32	1
LMLP04B4M101CTAS	100	±20%	0.4	0.27	1.5
LMLP04B4M151CTAS	150	±20%	0.31	0.22	2.5
LMLP04B4M221CTAS	220	±20%	0.27	0.17	4

### 0505

AVX PN	L (μH) at 100KHz 1.0V	Tolerance	I <sub>SAT</sub> * (A)	I <sub>RMS</sub> ** (A)	DCR ±20% (Ω)
LMLP0505M100CTAR	10	±20%	1	0.94	0.48

### 05B5

AVX PN	L (μH) at 100KHz 1.0V	Tolerance	I <sub>SAT</sub> * (A)	I <sub>RMS</sub> ** (A)	DCR ±20% (Ω)
LMLP05B5N1R5CTAR	1.5	±30%	3.35	3.2	0.026
LMLP05B5N2R2CTAR	2.2	±30%	2.9	2.9	0.035
LMLP05B5N3R3CTAR	3.3	±30%	2.4	2.4	0.048
LMLP05B5N4R7CTAR	4.7	±30%	2	2	0.06
LMLP05B5N6R8CTAR	6.8	±30%	1.6	1.65	0.09
LMLP05B5M100CTAR	10	±20%	1.3	1.45	0.12
LMLP05B5M150CTAR	15	±20%	1.1	1.2	0.165
LMLP05B5M220CTAR	22	±20%	0.9	1	0.26

### 05D5

AVX PN	L (μH) at 100KHz 1.0V	Tolerance	I <sub>SAT</sub> * (A)	I <sub>RMS</sub> ** (A)	DCR ±20% (Ω)
LMLP05D5N1R5CTAS	1.5	±30%	6	3.6	0.02
LMLP05D5N2R2CTAS	2.2	±30%	4.6	3.5	0.022
LMLP05D5N3R3CTAS	3.3	±30%	3.8	3.3	0.027
LMLP05D5N4R7CTAS	4.7	±30%	3.3	3.1	0.029
LMLP05D5N6R8CTAS	6.8	±30%	2.6	2.3	0.049
LMLP05D5M100CTAS	10	±20%	2.3	2.1	0.056
LMLP05D5M150CTAS	15	±20%	2	1.8	0.08
LMLP05D5M220CTAS	22	±20%	1.6	1.4	0.126
LMLP05D5M330CTAS	33	±20%	1.3	1.2	0.18
LMLP05D5M470CTAS	47	±20%	1.1	0.9	0.31

\*The saturation current value (ISAT) is the DC current value when the inductance decreases by 30% of its initial value (at 20°C).

\*\*The temperature rise current value (IRMS) is the DC current value that increases component temperature by up to 40°C.

# LMax Low Profile Power Inductor

## LMLP Series – Style C



### 0606

AVX PN	L (μH) at 100KHz 1.0V	Tolerance	I <sub>SAT</sub> * (A)	I <sub>RMS</sub> ** (A)	DCR ±20% (Ω)
LMLP0606N4R7CTAR	4.7	±30%	1.4	1.4	0.29
LMLP0606N6R8CTAR	6.8	±30%	1.2	1	0.372
LMLP0606M100CTAR	10	±20%	1	0.85	0.5

### 06A6

AVX PN	L (μH) at 100KHz 1.0V	Tolerance	I <sub>SAT</sub> * (A)	I <sub>RMS</sub> ** (A)	DCR ±20% (Ω)
LMLP06A6N2R5CTAR	2.5	±30%	2.1	1.73	0.09
LMLP06A6N6R8CTAR	6.8	±30%	1.3	1.18	0.165
LMLP06A6M100CTAR	10	±20%	1	1	0.235
LMLP06A6M150CTAR	15	±20%	0.8	0.79	0.33
LMLP06A6M220CTAR	22	±20%	0.76	0.63	0.53
LMLP06A6M330CTAR	33	±20%	0.59	0.53	0.7
LMLP06A6M470CTAR	47	±20%	0.52	0.46	1.05
LMLP06A6M680CTAR	68	±20%	0.44	0.41	1.35
LMLP06A6M101CTAR	100	±20%	0.35	0.32	2.18

### 06B6

AVX PN	L (μH) at 100KHz 1.0V	Tolerance	I <sub>SAT</sub> * (A)	I <sub>RMS</sub> ** (A)	DCR ±20% (Ω)
LMLP06B6N0R8CTAS	0.8	±30%	5.5	3.8	0.02
LMLP06B6N1R5CTAS	1.5	±30%	4	3.2	0.026
LMLP06B6N2R2CTAS	2.2	±30%	3.2	2.7	0.034
LMLP06B6N3R3CTAS	3.3	±30%	2.8	2.6	0.04
LMLP06B6N4R7CTAS	4.7	±30%	2.4	2	0.058
LMLP06B6N6R8CTAS	6.8	±30%	2	1.8	0.085
LMLP06B6M100CTAS	10	±20%	1.7	1.4	0.125
LMLP06B6M220CTAS	22	±20%	1.05	0.95	0.29

### 06C6

AVX PN	L (μH) at 100KHz 1.0V	Tolerance	I <sub>SAT</sub> * (A)	I <sub>RMS</sub> ** (A)	DCR ±20% (Ω)
LMLP06C6N1R5CTAS	1.5	±30%	5	4.2	0.016
LMLP06C6N2R2CTAS	2.2	±30%	4.2	3.7	0.02
LMLP06C6N3R0CTAS	3	±30%	3.6	3.4	0.023
LMLP06C6N4R7CTAS	4.7	±30%	2.7	3	0.031
LMLP06C6N6R0CTAS	6	±30%	2.5	2.5	0.04
LMLP06C6M100CTAS	10	±20%	1.9	1.9	0.065
LMLP06C6M150CTAS	15	±20%	1.6	1.8	0.095
LMLP06C6M220CTAS	22	±20%	1.3	1.4	0.135
LMLP06C6M330CTAS	33	±20%	1.1	1.1	0.22
LMLP06C6M470CTAS	47	±20%	0.95	0.92	0.3
LMLP06C6M680CTAS	68	±20%	0.76	0.77	0.42
LMLP06C6M101CTAS	100	±20%	0.62	0.66	0.6

\*The saturation current value (ISAT) is the DC current value when the inductance decreases by 30% of its initial value (at 20°C).

\*\*The temperature rise current value (IRMS) is the DC current value that increases component temperature by up to 40°C.



# LMax Low Profile Power Inductor

## LMLP Series – Style C

### 06D6

AVX PN	L (μH) at 100KHz 1.0V	Tolerance	I <sub>SAT</sub> * (A)	I <sub>RMS</sub> ** (A)	DCR ±20% (Ω)
LMLP06D6N1R3CTAS	1.3	±30%	8	4	0.016
LMLP06D6N1R8CTAS	1.8	±30%	7	3.7	0.018
LMLP06D6N2R3CTAS	2.3	±30%	6	3.5	0.021
LMLP06D6N3R0CTAS	3	±30%	5	3.2	0.024
LMLP06D6N4R5CTAS	4.5	±30%	4	3	0.031
LMLP06D6N6R3CTAS	6.3	±30%	3.8	2.8	0.038
LMLP06D6M100CTAS	10	±20%	3	2.5	0.047
LMLP06D6M150CTAS	15	±20%	2.3	1.9	0.077
LMLP06D6M220CTAS	22	±20%	1.9	1.5	0.115
LMLP06D6M330CTAS	33	±20%	1.5	1.4	0.145
LMLP06D6M470CTAS	47	±20%	1.3	1.1	0.22
LMLP06D6M680CTAS	68	±20%	1	0.9	0.33
LMLP06D6M101CTAS	100	±20%	0.8	0.7	0.5

### 0808

AVX PN	L (μH) at 100KHz 1.0V	Tolerance	I <sub>SAT</sub> * (A)	I <sub>RMS</sub> ** (A)	DCR ±20% (Ω)
LMLP0808N0R9CTAS	0.9	±30%	11	7.8	0.006
LMLP0808N1R4CTAS	1.4	±30%	9	7	0.007
LMLP0808N2R0CTAS	2	±30%	7.4	6.3	0.009
LMLP0808N3R6CTAS	3.6	±30%	5.3	4.9	0.015
LMLP0808N4R7CTAS	4.7	±30%	4.7	4.1	0.018
LMLP0808N6R8CTAS	6.8	±30%	4	3.7	0.025
LMLP0808M100CTAS	10	±20%	3.4	3.1	0.034
LMLP0808M150CTAS	15	±20%	2.7	2.4	0.05
LMLP0808M220CTAS	22	±20%	2.2	2.2	0.066

\*The saturation current value (ISAT) is the DC current value when the inductance decreases by 30% of its initial value (at 20°C).

\*\*The temperature rise current value (IRMS) is the DC current value that increases component temperature by up to 40°C.

## RECOMMENDED REFLOW PROFILE

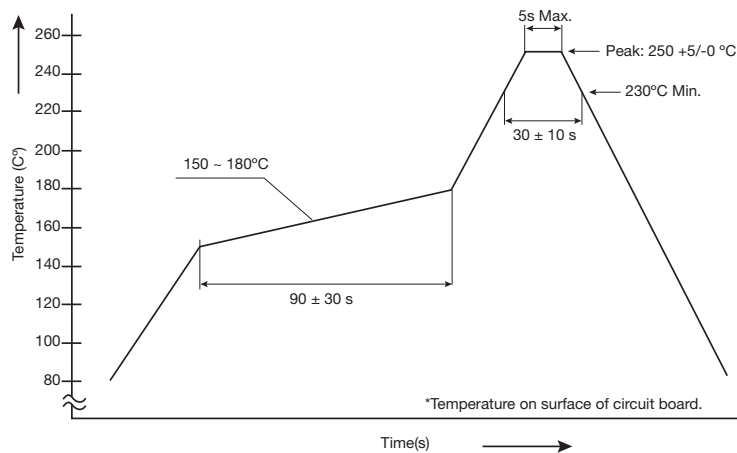



The products may be exposed to reflow soldering process of above profile up to two times.

# LMax Low Profile Power Inductor

## LMLP Series – Style C

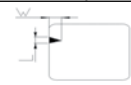
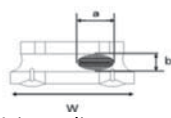
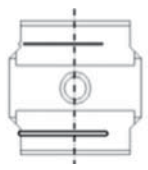
### TEST CONDITIONS

ITEM	SPECIFICATION DESCRIPTION	TEST METHOD
Temperature Range	Operation temp.: -40°C ~ +125°C (Including self-generated heat) Storage temp.: -40°C ~ +85°C	–
Appearance	No defects or abnormalities.	Visual inspection
Core Chipping	The appearance standard of the chipping size in top side, of bottom side ferrite core is following dimension. L: 0.5 mm (max) W: 0.5 mm (max)	 Using calipers
Void Appearance Exposed	Size of voids occurring to coating resin is specified as following. 1. Width direction (dimension a): acceptable when $a \leq w/2$ nonconforming when $a > w/2$ 2. Length direction (dimension b): it is not specified. 3. When total area of voids (including one exposing coil) occurring to each sides is not greater than 50% of coating resin area that is acceptable	 Using calipers
Electrode Appearance Criterion for Exposed Wire	 <Cross section of wire joint part> Only top side of wire exposed. (regardless of whole top side of wire exposed)	<Appearance judgement> Conforming
Solderability	 Wire is soldered insufficiently and less than half of outer diameter is covered with solder.	Less than 1/2 of joint side Length (More than 1/2 is selected as defect)  Solder heat proof: 1. Preheating: 160±10°C 90s 2. Retention time: 245±5°C for 3 ± 1 sec
Vibration	Inductance change: within ± 10% without mechanical damage such as break	1. Vibration frequency: (10Hz to 55Hz to 10Hz) in 60 sec. as a period 2. Vibration time: period cycled for 2 hr in each of 3 mutual perpendicular directions 3. Amplitude: 1.5mm max.
Terminal Strength	No detachment of terminal pin and no breakage of wire	Add static load 4.9N(500gf) to inductor through hole of test board for 10 ± 2 sec
Thermal Shock	Inductance change: within ± 10% without mechanical damage such as break	1. Repeat 100 cycles as follow: (-40°C ± 2°C, 30 ± 3 minutes) → (room temperature, 5 minutes) → (+125°C ± 2°C, 30 ± 3 minutes) → (room temperature, 5 minutes) 2. Recovery: 48 +4/-0 hours of recovery under the standard condition after the test.
High Temperature Resistance	Inductance change: within ± 10% without mechanical damage such as break	1. Environment condition: 85°C ± 2°C 2. Applied current: rated current 3. Duration: 500 +4/-0 hours
Humidity Resistance	Inductance change: within ± 10% without mechanical damage such as break	1. Environment condition: 60°C ± 2°C 2. Humidity: 90~95% 3. Applied current: rated current 4. Duration: 500 +4/-0 hours
Low Temperature Storage	Inductance change: within ± 10% without mechanical damage such as break	Store temperature: -40°C ± 2°C for total 500 +4/-0 hours
High Temperature Storage	Inductance change: within ± 10% without mechanical damage such as break	Store temperature: +125°C ± 2°C for total 500 +4/-0 hours
Inductance	a. Temperature: 25 ± 3°C b. Relative Humidity: 45 to 75%RH c. Measuring equipment: Current measure: Chroma 3302 + Chroma 1320	Within specified tolerance
DC Resistance	Measuring instrument: Chroma A165022	In accordance with electrical specification.

# LMax Low Profile Power Inductor

## LMLP Series – Style C

### PACKAGING SPECIFICATIONS – CARRIER TAPE DIMENSIONS

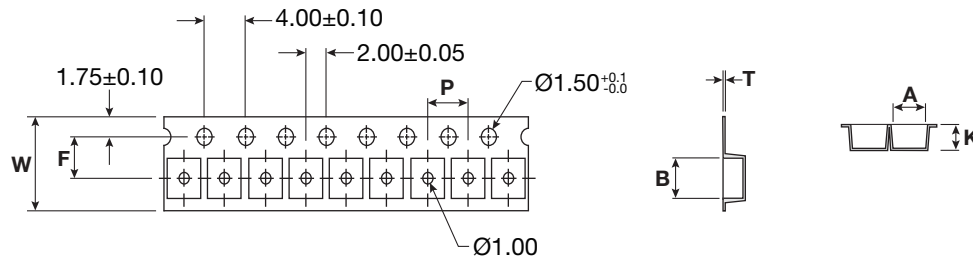

AVX PN	A	B	P	F	W	T	K	Reel Size	SPQ
LMLP0202****CTAR	2.6 ± 0.1 (0.102 ± 0.004)	2.6 ± 0.1 (0.102 ± 0.004)	4 ± 0.1 (0.157 ± 0.004)	3.5 ± 0.1 (0.138 ± 0.004)	8.0 ± 0.2 (0.315 ± 0.008)	0.25 ± 0.05 (0.009 ± 0.002)	1.3 ± 0.1 (0.051 ± 0.004)	7"	2500
LMLP0303****CTAR	3.2 ± 0.1 (0.126 ± 0.004)	3.2 ± 0.1 (0.126 ± 0.004)	4.0 ± 0.1 (0.157 ± 0.004)	3.5 ± 0.1 (0.138 ± 0.004)	8.0 ± 0.2 (0.315 ± 0.008)	0.3 ± 0.05 (0.012 ± 0.002)	1.4 ± 0.1 (0.055 ± 0.004)	7"	2000
LMLP03A2****CTAR	3.2 ± 0.1 (0.126 ± 0.004)	3.2 ± 0.1 (0.126 ± 0.004)	4.0 ± 0.1 (0.157 ± 0.004)	3.5 ± 0.1 (0.138 ± 0.004)	8.0 ± 0.2 (0.315 ± 0.008)	0.3 ± 0.05 (0.012 ± 0.002)	1.6 ± 0.1 (0.063 ± 0.004)	7"	2000
LMLP03B3****CTAR	3.2 ± 0.1 (0.126 ± 0.004)	3.2 ± 0.1 (0.126 ± 0.004)	4.0 ± 0.1 (0.157 ± 0.004)	3.5 ± 0.1 (0.138 ± 0.004)	8.0 ± 0.2 (0.315 ± 0.008)	0.3 ± 0.05 (0.012 ± 0.002)	1.9 ± 0.1 (0.075 ± 0.004)	7"	2000
LMLP0404****CTAS	4.3 ± 0.1 (0.169 ± 0.004)	4.3 ± 0.1 (0.169 ± 0.004)	8.0 ± 0.1 (0.315 ± 0.004)	5.5 ± 0.1 (0.217 ± 0.004)	12.0 ± 0.3 (0.472 ± 0.012)	0.3 ± 0.1 (0.012 ± 0.004)	1.4 ± 0.1 (0.055 ± 0.004)	13"	5000
LMLP04A4****CTAS	4.3 ± 0.1 (0.169 ± 0.004)	4.3 ± 0.1 (0.169 ± 0.004)	8.0 ± 0.1 (0.315 ± 0.004)	5.5 ± 0.1 (0.217 ± 0.004)	12.0 ± 0.3 (0.472 ± 0.012)	0.3 ± 0.1 (0.012 ± 0.004)	1.6 ± 0.1 (0.063 ± 0.004)	13"	4500
LMLP04B4****CTAS	4.3 ± 0.1 (0.169 ± 0.004)	4.3 ± 0.1 (0.169 ± 0.004)	8.0 ± 0.1 (0.315 ± 0.004)	5.5 ± 0.1 (0.217 ± 0.004)	12.0 ± 0.3 (0.472 ± 0.012)	0.3 ± 0.1 (0.012 ± 0.004)	2.1 ± 0.1 (0.083 ± 0.004)	13"	3500
LMLP0505****CTAR	5.25 ± 0.1 (0.207 ± 0.004)	5.25 ± 0.1 (0.207 ± 0.004)	8.0 ± 0.1 (0.315 ± 0.004)	5.5 ± 0.1 (0.217 ± 0.004)	12.0 ± 0.3 (0.472 ± 0.012)	0.3 ± 0.1 (0.012 ± 0.004)	1.4 ± 0.1 (0.055 ± 0.004)	7"	1000
LMLP05B5****CTAR	5.25 ± 0.1 (0.207 ± 0.004)	5.25 ± 0.1 (0.207 ± 0.004)	8.0 ± 0.1 (0.315 ± 0.004)	5.5 ± 0.1 (0.217 ± 0.004)	12.0 ± 0.3 (0.472 ± 0.012)	0.3 ± 0.1 (0.012 ± 0.004)	2.3 ± 0.1 (0.091 ± 0.004)	7"	800
LMLP05D5****CTAS	5.15 ± 0.1 (0.203 ± 0.004)	5.15 ± 0.1 (0.203 ± 0.004)	8.0 ± 0.1 (0.315 ± 0.004)	5.5 ± 0.1 (0.217 ± 0.004)	12.0 ± 0.3 (0.472 ± 0.012)	0.4 ± 0.1 (0.016 ± 0.004)	4.2 ± 0.1 (0.165 ± 0.004)	13"	1500
LMLP0606****CTAR	6.3 ± 0.1 (0.248 ± 0.004)	6.3 ± 0.1 (0.248 ± 0.004)	8.0 ± 0.1 (0.315 ± 0.004)	5.5 ± 0.1 (0.217 ± 0.004)	12.0 ± 0.3 (0.472 ± 0.012)	0.4 ± 0.1 (0.016 ± 0.004)	1.4 ± 0.1 (0.055 ± 0.004)	7"	1000
LMLP06A6****CTAR	6.3 ± 0.1 (0.248 ± 0.004)	6.3 ± 0.1 (0.248 ± 0.004)	8.0 ± 0.1 (0.315 ± 0.004)	5.5 ± 0.1 (0.217 ± 0.004)	12.0 ± 0.3 (0.472 ± 0.012)	0.4 ± 0.1 (0.016 ± 0.004)	1.6 ± 0.1 (0.063 ± 0.004)	7"	1000
LMLP06B6****CTAS	6.3 ± 0.1 (0.248 ± 0.004)	6.3 ± 0.1 (0.248 ± 0.004)	8.0 ± 0.1 (0.315 ± 0.004)	5.5 ± 0.1 (0.217 ± 0.004)	12.0 ± 0.3 (0.472 ± 0.012)	0.4 ± 0.1 (0.016 ± 0.004)	2.3 ± 0.1 (0.091 ± 0.004)	13"	2500
LMLP06C6****CTAS	6.3 ± 0.1 (0.248 ± 0.004)	6.3 ± 0.1 (0.248 ± 0.004)	8.0 ± 0.1 (0.315 ± 0.004)	5.5 ± 0.1 (0.217 ± 0.004)	12.0 ± 0.3 (0.472 ± 0.012)	0.4 ± 0.1 (0.016 ± 0.004)	3.1 ± 0.1 (0.122 ± 0.004)	13"	2000
LMLP06D6****CTAS	6.3 ± 0.1 (0.248 ± 0.004)	6.3 ± 0.1 (0.248 ± 0.004)	8.0 ± 0.1 (0.315 ± 0.004)	5.5 ± 0.1 (0.217 ± 0.004)	12.0 ± 0.3 (0.472 ± 0.012)	0.4 ± 0.1 (0.016 ± 0.004)	4.7 ± 0.1 (0.185 ± 0.004)	13"	1500
LMLP0808****CTAS	8.3 ± 0.1 (0.327 ± 0.004)	8.3 ± 0.1 (0.327 ± 0.004)	12.0 ± 0.1 (0.472 ± 0.004)	7.5 ± 0.1 (0.295 ± 0.004)	16.0 ± 0.3 (0.630 ± 0.012)	0.5 ± 0.1 (0.020 ± 0.004)	4.5 ± 0.1 (0.177 ± 0.004)	13"	1000

### PACKAGING SPECIFICATIONS – REEL DIMENSIONS

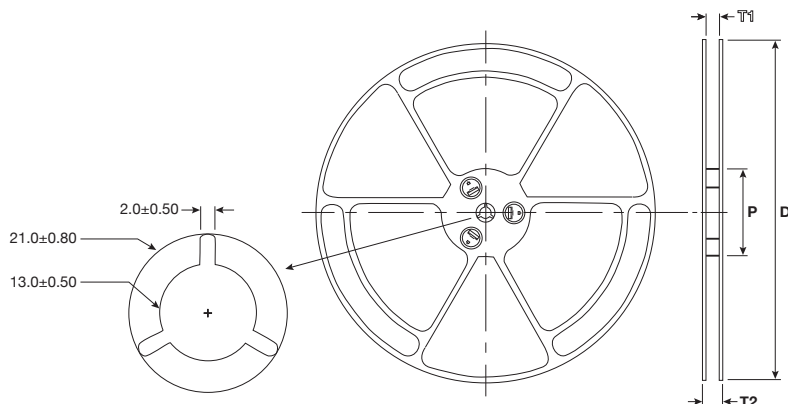

Code	7" Reel	13" Reel
D	180±1.50	330±1.50
P	62.0±1.50	100±1.50

# LMax Low Profile/High Current Power Inductor

## LMLP Series – Style D



### FEATURES

- Shielded Construction
- Large Current Rating
- Lower Temperature Rise
- Low Profile
- Available on tape and reel

### APPLICATIONS

- Personal Computers
- Servers
- High Current POL Converters
- Low Profile High Current Power Supplies
- DC/DC Converters
- DC/DC Converters for FPGA

### INDUCTANCE AND RATED CURRENT RANGES

• 0405	0.1 $\mu$ H ~ 3.3 $\mu$ H	22 ~ 4 A
• 05A6	0.1 $\mu$ H ~ 4.7 $\mu$ H	45 ~ 5 A
• 0506	0.1 $\mu$ H ~ 4.7 $\mu$ H	27 ~ 8.2 A
• 0707	0.1 $\mu$ H ~ 4.7 $\mu$ H	40 ~ 8 A
• 07A7	0.1 $\mu$ H ~ 10 $\mu$ H	50 ~ 7 A
• 07B7	0.1 $\mu$ H ~ 10 $\mu$ H	60 ~ 7 A
• 07C7	0.56 $\mu$ H ~ 10 $\mu$ H	12 ~ 4.5 A
• 1011	0.19 $\mu$ H ~ 47 $\mu$ H	90 ~ 3 A
• 13A3	0.1 $\mu$ H ~ 10 $\mu$ H	84 ~ 14 A
• 1313	0.1 $\mu$ H ~ 10 $\mu$ H	118 ~ 16 A
• 13B3	0.1 $\mu$ H ~ 10 $\mu$ H	120 ~ 15.5 A

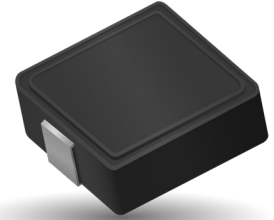

- All test data taken at 25°C
- Operating Temperature Range: -55°C ~ +155°C
- $I_{SAT}$ : The current that causes an inductance drop of approximately 25% (30% on 0405 size).
- $I_{DC}$ : DC Current that causes an approximate  $\Delta T$  of 40°C.



### DIMENSIONS

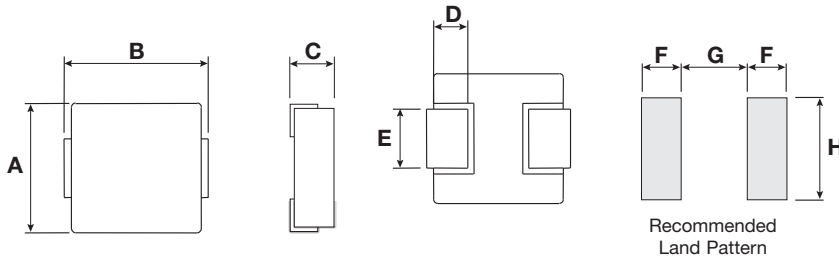

mm

Type	A	B	C	D	E	F	G	H
0405	4.0±0.3	4.45±0.25	1.8±0.2	0.8±0.3	1.5±0.3	1.5	2.22	2.5
05A6	5.2±0.2	5.7±0.7	1.8±0.2	1.1±0.3	2.5±0.3	2	2.2	2.8
0506	5.2±0.3	5.4±0.3	3.0±MAX	1.2±0.2	2.2±0.3	1.9	2.2	2.5
0707	6.6±0.3	7.0±0.3	1.8±0.2	1.8±0.3	3.0±0.3	2.6	2.5	3.5
07B7	6.6±0.3	7.3±0.3	2.2±0.2	1.8±0.3	3.0±0.3	2.6	2.5	3.5
07A7	6.6±0.2	7.3±MAX	3.0±MAX	1.6±0.3	3.0±0.3	1.85	3.7	3.5
07C7	6.6±0.3	7.3±0.3	4.8±0.2	1.8±0.3	3.0±0.3	2.95	2.5	3.5
1011	10.0±0.3	11.15±0.35	4.0±MAX	2.0±0.5	3.0±0.5	4.05	5.4	4.4
1313	12.8±0.5	13.5±1.0	5.0±MAX	2.5±0.5	3.8±0.5	3.25	8	5
13B3	12.8±0.5	13.5±1.0	6.5±MAX	2.5±0.5	3.2±0.5	3.25	8	5

### HOW TO ORDER

<b>LM</b>	<b>LP</b>	<b>0707</b>	<b>M</b>	<b>R04</b>	<b>D</b>	<b>T</b>	<b>A</b>	<b>S</b>
<b>Family</b>	<b>Series</b>	<b>Size</b>	<b>Tolerance</b>	<b>Inductance</b>	<b>Style</b>	<b>Termination</b>	<b>Special</b>	<b>Packaging</b>
LM = Power Inductor	LP = Low Profile	0707 = 7x7xh 07A7 = 7x7xA(h) (h = see catalog)	M = 20%	R39 = 0.390 $\mu$ H 3R9 = 3.900 $\mu$ H 390 = 39.00 $\mu$ H 391 = 390.0 $\mu$ H	T = Sn Plate	A = Standard	S = 13" Reel	



The Important Information/Disclaimer is incorporated in the catalog where these specifications came from or available online at [www.avx.com/disclaimer/](http://www.avx.com/disclaimer/) by reference and should be reviewed in full before placing any order.

# LMax Low Profile/High Current Power Inductor

## LMLP Series – Style D



### ELECTRICAL CHARACTERISTICS

#### 0405

AVX PN	Inductance (μH)	Tolerance	Test Condition	DCR (mΩ) Typical	DCR (mΩ) Max	I <sub>DC</sub> (A) Typical	I <sub>sat</sub> (A) Typical
LMLP0405MR10DTAS	0.1	±20%	100KHz, 0.25V	3.5	4	12	22
LMLP0405MR15DTAS	0.15	±20%	100KHz, 0.25V	6	6.6	9	13
LMLP0405MR22DTAS	0.22	±20%	100KHz, 0.25V	6	6.6	9	12.5
LMLP0405MR47DTAS	0.47	±20%	100KHz, 0.25V	12.5	14	7	9.5
LMLP0405MR56DTAS	0.56	±20%	100KHz, 0.25V	14	16	6.5	10
LMLP0405MR68DTAS	0.68	±20%	100KHz, 0.25V	16	18	6	9
LMLP0405M1R0DTAS	1	±20%	100KHz, 0.25V	24	27	4.5	7
LMLP0405M1R2DTAS	1.2	±20%	100KHz, 0.25V	24	27	4.5	7
LMLP0405M1R5DTAS	1.5	±20%	100KHz, 0.25V	38	46	4	6
LMLP0405M2R2DTAS	2.2	±20%	100KHz, 0.25V	52	58	3	5
LMLP0405M3R3DTAS	3.3	±20%	100KHz, 0.25V	74	87	2.5	4
LMLP0405M4R7DTAS	4.7	±20%	100KHz, 0.25V	98	110	2.2	3.5
LMLP0405M5R6DTAS	5.6	±20%	100KHz, 0.25V	105	115	1.8	3.5
LMLP0405M6R8DTAS	6.8	±20%	100KHz, 0.25V	160	175	1.5	2.5
LMLP0405M100DTAS	10	±20%	100KHz, 0.25V	256	282	1.2	2.2

#### 05A6

AVX PN	Inductance (μH)	Tolerance	Test Condition	DCR (mΩ) Typical	DCR (mΩ) Max	I <sub>DC</sub> (A) Typical	I <sub>sat</sub> (A) Typical
LMLP05A6MR10DTAS	0.1	±20%	100KHz, 0.25V	3.6	4	18	45
LMLP05A6MR15DTAS	0.15	±20%	100KHz, 0.25V	3.8	4.6	16	27
LMLP05A6MR22DTAS	0.22	±20%	100KHz, 0.25V	4	5.5	15	25
LMLP05A6MR24DTAS	0.24	±20%	100KHz, 0.25V	6	7	13	23
LMLP05A6MR33DTAS	0.33	±20%	100KHz, 0.25V	6.3	7.3	12	21.3
LMLP05A6MR47DTAS	0.47	±20%	100KHz, 0.25V	7.3	8.6	11.5	18
LMLP05A6MR68DTAS	0.68	±20%	100KHz, 0.25V	11	12.4	10	12.8
LMLP05A6M1R0DTAS	1	±20%	100KHz, 0.25V	17.5	20	7	13.7
LMLP05A6M1R2DTAS	1.2	±20%	100KHz, 0.25V	23	28	6.2	11
LMLP05A6M1R5DTAS	1.5	±20%	100KHz, 0.25V	26.5	30.5	5.5	9.8
LMLP05A6M2R2DTAS	2.2	±20%	100KHz, 0.25V	42	50	4.2	9
LMLP05A6M3R3DTAS	3.3	±20%	100KHz, 0.25V	66	76	3.3	7.3
LMLP05A6M4R7DTAS	4.7	±20%	100KHz, 0.25V	103	116	2.8	5
LMLP05A6M5R6DTAS	5.6	±20%	100KHz, 0.25V	112	122	2.5	4
LMLP05A6M6R8DTAS	6.8	±20%	100KHz, 0.25V	130	150	2.4	3.8
LMLP05A6M8R2DTAS	8.2	±20%	100KHz, 0.25V	148	171	2.3	3.5
LMLP05A6M100DTAS	10	±20%	100KHz, 0.25V	180	199	2.3	3.4
LMLP05A6M150DTAS	15	±20%	100KHz, 0.25V	240	270	1.9	2.8
LMLP05A6M220DTAS	22	±20%	100KHz, 0.25V	350	390	1.5	1.8

I<sub>SAT</sub>: The current that causes an inductance drop of approximately 25% (30% on 0405 size).  
 I<sub>DC</sub>: DC Current that causes an approximate ΔT of 40°C.

# LMax Low Profile/High Current Power Inductor

## LMLP Series – Style D



### 0506

AVX PN	Inductance (μH)	Tolerance	Test Condition	DCR (mΩ) Typical	DCR (mΩ) Max	I <sub>DC</sub> (A) Typical	I <sub>sat</sub> (A) Typical
LMLP0506MR20DTAS	0.2	±20%	100KHz, 0.25V	3.5	3.9	18	14.5
LMLP0506MR47DTAS	0.47	±20%	100KHz, 0.25V	7.4	8.5	13.5	12
LMLP0506MR68DTAS	0.68	±20%	100KHz, 0.25V	11	12	8.5	14
LMLP0506M1R0DTAS	1	±20%	100KHz, 0.25V	13	14	7	11
LMLP0506M1R2DTAS	1.2	±20%	100KHz, 0.25V	15	16	6.5	11
LMLP0506M1R5DTAS	1.5	±20%	100KHz, 0.25V	20	25	6	8.5
LMLP0506M2R2DTAS	2.2	±20%	100KHz, 0.25V	25	29	5.5	7.5
LMLP0506M3R3DTAS	3.3	±20%	100KHz, 0.25V	32	38	5	6
LMLP0506M4R7DTAS	4.7	±20%	100KHz, 0.25V	50	60	3.5	5
LMLP0506M6R8DTAS	6.8	±20%	100KHz, 0.25V	75	90	3	4
LMLP0506M100DTAS	10	±20%	100KHz, 0.25V	110	125	2.5	3.5

### 0707

AVX PN	Inductance (μH)	Tolerance	Test Condition	DCR (mΩ) Typical	DCR (mΩ) Max	I <sub>DC</sub> (A) Typical	I <sub>sat</sub> (A) Typical
LMLP0707MR10DTAS	0.1	±20%	100KHz, 0.25V	2	2.4	21	40
LMLP0707MR15DTAS	0.15	±20%	100KHz, 0.25V	2.3	2.7	18	39
LMLP0707MR16DTAS	0.16	±20%	100KHz, 0.25V	2.3	2.7	18	38
LMLP0707MR18DTAS	0.18	±20%	100KHz, 0.25V	2.4	2.9	18	36
LMLP0707MR20DTAS	0.2	±20%	100KHz, 0.25V	2.5	3	18	35
LMLP0707MR22DTAS	0.22	±20%	100KHz, 0.25V	3.5	4	15	32
LMLP0707MR24DTAS	0.24	±20%	100KHz, 0.25V	3.6	4.3	14.5	32
LMLP0707MR33DTAS	0.33	±20%	100KHz, 0.25V	4.5	5	14	25
LMLP0707MR47DTAS	0.47	±20%	100KHz, 0.25V	7.1	8.3	11.7	20
LMLP0707MR56DTAS	0.56	±20%	100KHz, 0.25V	7.9	9.3	11	18
LMLP0707MR68DTAS	0.68	±20%	100KHz, 0.25V	8.3	10	10.5	16
LMLP0707M1R0DTAS	1	±20%	100KHz, 0.25V	16.5	18	8	14
LMLP0707M1R2DTAS	1.2	±20%	100KHz, 0.25V	19	23	7.5	13
LMLP0707M1R5DTAS	1.5	±20%	100KHz, 0.25V	23	27	7	12
LMLP0707M2R2DTAS	2.2	±20%	100KHz, 0.25V	32	37	6	10
LMLP0707M3R3DTAS	3.3	±20%	100KHz, 0.25V	43	48	5	8
LMLP0707M4R7DTAS	4.7	±20%	100KHz, 0.25V	53	60	4.5	7
LMLP0707M5R6DTAS	5.6	±20%	100KHz, 0.25V	59	68	4	6
LMLP0707M6R8DTAS	6.8	±20%	100KHz, 0.25V	63	73	4	5.5
LMLP0707M8R2DTAS	8.2	±20%	100KHz, 0.25V	101	116	3.2	5
LMLP0707M100DTAS	10	±20%	100KHz, 0.25V	134	154	2.8	4
LMLP0707M150DTAS	15	±20%	100KHz, 0.25V	190	210	2.1	3.3
LMLP0707M220DTAS	22	±20%	100KHz, 0.25V	236	280	1.5	2.5

I<sub>SAT</sub>: The current that causes an inductance drop of approximately 25% (30% on 0405 size).  
 I<sub>DC</sub>: DC Current that causes an approximate ΔT of 40°C.

# LMax Low Profile/High Current Power Inductor

## LMLP Series – Style D



### 07B7

AVX PN	Inductance (µH)	Tolerance	Test Condition	DCR (mΩ) Typical	DCR (mΩ) Max	I <sub>DC</sub> (A) Typical	I <sub>sat</sub> (A) Typical
LMLP07B7MR10DTAS	0.1	±20%	100KHz, 0.25V	1.4	1.7	30	70
LMLP07B7MR15DTAS	0.15	±20%	100KHz, 0.25V	1.8	2.3	30	45
LMLP07B7MR20DTAS	0.2	±20%	100KHz, 0.25V	1.9	2.8	23	40
LMLP07B7MR22DTAS	0.22	±20%	100KHz, 0.25V	2	3.2	21	34
LMLP07B7MR33DTAS	0.33	±20%	100KHz, 0.25V	3.6	4.4	18	30
LMLP07B7MR36DTAS	0.36	±20%	100KHz, 0.25V	3.8	4.6	17	29
LMLP07B7MR47DTAS	0.47	±20%	100KHz, 0.25V	4.8	5.1	15	26
LMLP07B7MR56DTAS	0.56	±20%	100KHz, 0.25V	5.5	6.5	13	24
LMLP07B7MR60DTAS	0.6	±20%	100KHz, 0.25V	5.7	6.9	13	22
LMLP07B7MR68DTAS	0.68	±20%	100KHz, 0.25V	6.4	7.2	13	21
LMLP07B7MR82DTAS	0.82	±20%	100KHz, 0.25V	8	9.5	11	17
LMLP07B7M1R0DTAS	1	±20%	100KHz, 0.25V	10.5	13.5	11	16
LMLP07B7M1R5DTAS	1.5	±20%	100KHz, 0.25V	17	20	9	15
LMLP07B7M2R2DTAS	2.2	±20%	100KHz, 0.25V	23	28	7	14
LMLP07B7M3R3DTAS	3.3	±20%	100KHz, 0.25V	34	39	6	10
LMLP07B7M4R7DTAS	4.7	±20%	100KHz, 0.25V	41	50	5.5	9
LMLP07B7M5R6DTAS	5.6	±20%	100KHz, 0.25V	56	62	5	8
LMLP07B7M6R8DTAS	6.8	±20%	100KHz, 0.25V	65	72	4	7
LMLP07B7M8R2DTAS	8.2	±20%	100KHz, 0.25V	81	95	3.6	6
LMLP07B7M100DTAS	10	±20%	100KHz, 0.25V	92	101	3.2	5
LMLP07B7M150DTAS	15	±20%	100KHz, 0.25V	150	180	2.5	3.5
LMLP07B7M220DTAS	22	±20%	100KHz, 0.25V	185	215	1.8	3

### 07A7

AVX PN	Inductance (µH)	Tolerance	Test Condition	DCR (mΩ) Typical	DCR (mΩ) Max	I <sub>DC</sub> (A) Typical	I <sub>sat</sub> (A) Typical
LMLP07A7MR22DTAS	0.22	±20%	100KHz, 0.25V	2.5	2.8	23	40
LMLP07A7MR33DTAS	0.33	±20%	100KHz, 0.25V	3.5	3.9	20	30
LMLP07A7MR47DTAS	0.47	±20%	100KHz, 0.25V	4	4.2	17.5	26
LMLP07A7MR56DTAS	0.56	±20%	100KHz, 0.25V	4.7	5	16.5	25.5
LMLP07A7MR68DTAS	0.68	±20%	100KHz, 0.25V	5	5.5	15.5	25
LMLP07A7MR82DTAS	0.82	±20%	100KHz, 0.25V	6.7	8	13	20
LMLP07A7M1R0DTAS	1	±20%	100KHz, 0.25V	9	10	11	20
LMLP07A7M1R5DTAS	1.5	±20%	100KHz, 0.25V	14	15	9	16
LMLP07A7M2R2DTAS	2.2	±20%	100KHz, 0.25V	17	20	8	12
LMLP07A7M3R3DTAS	3.3	±20%	100KHz, 0.25V	28	30	6	10
LMLP07A7M4R7DTAS	4.7	±20%	100KHz, 0.25V	37	40	5.5	7
LMLP07A7M5R6DTAS	5.6	±20%	100KHz, 0.25V	40	44	5.5	6
LMLP07A7M6R8DTAS	6.8	±20%	100KHz, 0.25V	54	60	4.5	6.5
LMLP07A7M8R2DTAS	8.2	±20%	100KHz, 0.25V	54	60	4.5	6
LMLP07A7M100DTAS	10	±20%	100KHz, 0.25V	62	68	4	5.5

I<sub>SAT</sub>: The current that causes an inductance drop of approximately 25% (30% on 0405 size).  
 I<sub>DC</sub>: DC Current that causes an approximate ΔT of 40°C.

# LMax Low Profile/High Current Power Inductor

## LMLP Series – Style D



### 07C7

AVX PN	Inductance (μH)	Tolerance	Test Condition	DCR (mΩ) Typical	DCR (mΩ) Max	I <sub>DC</sub> (A) Typical	I <sub>sat</sub> (A) Typical
LMLP07C7MR33DTAS	0.33	±20%	100KHz, 0.25V	2.5	3	25	32
LMLP07C7MR40DTAS	0.4	±20%	100KHz, 0.25V	3.1	3.7	23	31
LMLP07C7MR47DTAS	0.47	±20%	100KHz, 0.25V	3.5	3.9	22	30
LMLP07C7MR56DTAS	0.56	±20%	100KHz, 0.25V	3.6	4.2	20	27
LMLP07C7MR60DTAS	0.6	±20%	100KHz, 0.25V	3.8	4.3	19	25
LMLP07C7MR68DTAS	0.68	±20%	100KHz, 0.25V	4	4.5	18	24
LMLP07C7MR82DTAS	0.82	±20%	100KHz, 0.25V	4.6	4.9	15	22
LMLP07C7M1R0DTAS	1	±20%	100KHz, 0.25V	6.1	6.5	15	20
LMLP07C7M1R2DTAS	1.2	±20%	100KHz, 0.25V	6.7	7.5	14	18
LMLP07C7M1R5DTAS	1.5	±20%	100KHz, 0.25V	8.6	9	12	16.5
LMLP07C7M1R8DTAS	1.8	±20%	100KHz, 0.25V	9.5	11	12	15
LMLP07C7M2R2DTAS	2.2	±20%	100KHz, 0.25V	11.2	12	10	14
LMLP07C7M3R3DTAS	3.3	±20%	100KHz, 0.25V	19	20.9	8	12
LMLP07C7M4R7DTAS	4.7	±20%	100KHz, 0.25V	28	30.8	6.5	10
LMLP07C7M5R6DTAS	5.6	±20%	100KHz, 0.25V	43.5	49	6	9
LMLP07C7M6R8DTAS	6.8	±20%	100KHz, 0.25V	46	51.5	5.5	8.5
LMLP07C7M8R2DTAS	8.2	±20%	100KHz, 0.25V	56	63	5	8
LMLP07C7M100DTAS	10	±20%	100KHz, 0.25V	60	69	4	7.5
LMLP07C7M150DTAS	15	±20%	100KHz, 0.25V	81	92	3.5	6
LMLP07C7M220DTAS	22	±20%	100KHz, 0.25V	140	170	2.5	5.5
LMLP07C7M330DTAS	33	±20%	100KHz, 0.25V	173	200	2	3.5
LMLP07C7M470DTAS	47	±20%	100KHz, 0.25V	290	330	1.9	2.7
LMLP07C7M560DTAS	56	±20%	100KHz, 0.25V	342	396	1.6	2.1
LMLP07C7M680DTAS	68	±20%	100KHz, 0.25V	386	445	1.2	2

### 1011

AVX PN	Inductance (μH)	Tolerance	Test Condition	DCR (mΩ) Typical	DCR (mΩ) Max	I <sub>DC</sub> (A) Typical	I <sub>sat</sub> (A) Typical
LMLP1011MR22DTAS	0.22	±20%	100KHz, 0.25V	0.8	1	30	50
LMLP1011MR36DTAS	0.36	±20%	100KHz, 0.25V	1.1	1.2	34	40
LMLP1011MR47DTAS	0.47	±20%	100KHz, 0.25V	1.3	1.55	25	35
LMLP1011MR56DTAS	0.56	±20%	100KHz, 0.25V	1.6	1.8	25	32
LMLP1011MR68DTAS	0.68	±20%	100KHz, 0.25V	2.4	2.7	22	30
LMLP1011M1R0DTAS	1	±20%	100KHz, 0.25V	3	3.3	18	28
LMLP1011M1R5DTAS	1.5	±20%	100KHz, 0.25V	3.8	4.2	16	21
LMLP1011M2R2DTAS	2.2	±20%	100KHz, 0.25V	6.7	7	12	18
LMLP1011M3R3DTAS	3.3	±20%	100KHz, 0.25V	10.8	11.8	10	16
LMLP1011M4R7DTAS	4.7	±20%	100KHz, 0.25V	17	20	8.5	15
LMLP1011M6R8DTAS	6.8	±20%	100KHz, 0.25V	22.5	25	6.5	9
LMLP1011M8R2DTAS	8.2	±20%	100KHz, 0.25V	26	29	7	9
LMLP1011M100DTAS	10	±20%	100KHz, 0.25V	27	30	7.5	8.5
LMLP1011M150DTAS	15	±20%	100KHz, 0.25V	40	45	6.25	7
LMLP1011M220DTAS	22	±20%	100KHz, 0.25V	60	66	5	5.5
LMLP1011M470DTAS	47	±20%	100KHz, 0.25V	130	145	3.3	3.5

I<sub>SAT</sub>: The current that causes an inductance drop of approximately 25% (30% on 0405 size).  
 I<sub>DC</sub>: DC Current that causes an approximate ΔT of 40°C.



The Important Information/Disclaimer is incorporated in the catalog where these specifications came from or available online at [www.avx.com/disclaimer/](http://www.avx.com/disclaimer/) by reference and should be reviewed in full before placing any order.



# LMax Low Profile/High Current Power Inductor

## LMLP Series – Style D



### 1313

AVX PN	Inductance (μH)	Tolerance	Test Condition	DCR (mΩ) Typical	DCR (mΩ) Max	I <sub>DC</sub> (A) Typical	I <sub>sat</sub> (A) Typical
LMLP1313MR10DTAS	0.1	±20%	100KHz, 0.25V	0.53	0.6	55	118
LMLP1313MR22DTAS	0.22	±20%	100KHz, 0.25V	0.64	0.8	51	110
LMLP1313MR33DTAS	0.33	±20%	100KHz, 0.25V	0.85	1.1	42	80
LMLP1313MR47DTAS	0.47	±20%	100KHz, 0.25V	1.1	1.3	38	65
LMLP1313MR56DTAS	0.56	±20%	100KHz, 0.25V	1.3	1.5	36	55
LMLP1313MR68DTAS	0.68	±20%	100KHz, 0.25V	1.5	1.7	34	54
LMLP1313MR82DTAS	0.82	±20%	100KHz, 0.25V	2	2.3	31	53
LMLP1313M1R0DTAS	1	±20%	100KHz, 0.25V	2.1	2.5	29	50
LMLP1313M1R2DTAS	1.2	±20%	100KHz, 0.25V	2.8	3.5	25	49
LMLP1313M1R5DTAS	1.5	±20%	100KHz, 0.25V	3.4	4.1	23	48
LMLP1313M1R8DTAS	1.8	±20%	100KHz, 0.25V	4.2	4.9	19	40
LMLP1313M2R2DTAS	2.2	±20%	100KHz, 0.25V	4.6	5.5	20	32
LMLP1313M3R3DTAS	3.3	±20%	100KHz, 0.25V	7.7	9.2	15	32
LMLP1313M4R7DTAS	4.7	±20%	100KHz, 0.25V	12.8	15	12	27
LMLP1313M5R6DTAS	5.6	±20%	100KHz, 0.25V	14	16.5	11.5	22
LMLP1313M6R8DTAS	6.8	±20%	100KHz, 0.25V	15.4	18.5	11	21
LMLP1313M7R8DTAS	7.8	±20%	100KHz, 0.25V	17.2	20.5	10	18
LMLP1313M8R2DTAS	8.2	±20%	100KHz, 0.25V	18.9	22.5	9.5	18
LMLP1313M100DTAS	10	±20%	100KHz, 0.25V	21.4	25.5	9	16

### 13B3

AVX PN	Inductance (μH)	Tolerance	Test Condition	DCR (mΩ) Typical	DCR (mΩ) Max	I <sub>DC</sub> (A) Typical	I <sub>sat</sub> (A) Typical
LMLP13B3MR10DTAS	0.1	±20%	100KHz, 0.25V	0.47	0.5	60	120
LMLP13B3MR15DTAS	0.15	±20%	100KHz, 0.25V	0.53	0.6	55	118
LMLP13B3MR22DTAS	0.22	±20%	100KHz, 0.25V	0.63	0.7	53	112
LMLP13B3MR30DTAS	0.3	±20%	100KHz, 0.25V	0.7	0.8	48	72
LMLP13B3MR33DTAS	0.33	±20%	100KHz, 0.25V	0.83	0.9	46	65
LMLP13B3MR47DTAS	0.47	±20%	100KHz, 0.25V	1	1.2	41	63
LMLP13B3MR56DTAS	0.56	±20%	100KHz, 0.25V	1.2	1.4	37	62
LMLP13B3MR68DTAS	0.68	±20%	100KHz, 0.25V	1.4	1.6	35	60
LMLP13B3MR82DTAS	0.82	±20%	100KHz, 0.25V	1.6	1.9	33	50
LMLP13B3M1R0DTAS	1	±20%	100KHz, 0.25V	1.7	2	32	49
LMLP13B3M1R2DTAS	1.2	±20%	100KHz, 0.25V	2.1	2.5	30	48
LMLP13B3M1R5DTAS	1.5	±20%	100KHz, 0.25V	2.5	3	27	45
LMLP13B3M1R8DTAS	1.8	±20%	100KHz, 0.25V	2.8	3.2	24	41
LMLP13B3M2R2DTAS	2.2	±20%	100KHz, 0.25V	3.5	4.2	22	40
LMLP13B3M3R3DTAS	3.3	±20%	100KHz, 0.25V	5.7	6.8	18	35
LMLP13B3M4R7DTAS	4.7	±20%	100KHz, 0.25V	9.3	11.2	13.5	30
LMLP13B3M5R6DTAS	5.6	±20%	100KHz, 0.25V	11.8	12.8	12	26.5
LMLP13B3M6R8DTAS	6.8	±20%	100KHz, 0.25V	13.1	14	11.5	16.5
LMLP13B3M8R2DTAS	8.2	±20%	100KHz, 0.25V	14.5	15.5	10.5	16
LMLP13B3M100DTAS	10	±20%	100KHz, 0.25V	15.8	16.8	10	15.5
LMLP13B3M150DTAS	15	±20%	100KHz, 0.25V	25	29	6	9
LMLP13B3M220DTAS	22	±20%	100KHz, 0.25V	34	39.5	5	7.5
LMLP13B3M330DTAS	33	±20%	100KHz, 0.25V	55	65	4	6
LMLP13B3M470DTAS	47	±20%	100KHz, 0.25V	80	92	3	5
LMLP13B3M680DTAS	68	±20%	100KHz, 0.25V	122	134	2	3.5

I<sub>SAT</sub>: The current that causes an inductance drop of approximately 25% (30% on 0405 size).  
 I<sub>DC</sub>: DC Current that causes an approximate ΔT of 40°C.



# LMax Low Profile/High Current Power Inductor

## LMLP Series – Style D



### GENERAL CHARACTERISTICS

Items	Requirement	Test Methods		
Solderability	More than 90% of the terminal electrode should be covered with solder.	230±5°C for 4±1 seconds		
Solder Heat Resistance	Inductance value must remain within 20% of initial value. No disconnection or short circuit. No change in appearance.	260±5°C for 4±1 seconds		
Heat Resistance	Inductance value must remain within 20% of initial value. No disconnection or short circuit. No change in appearance.	Temperature: 125±5°C		
		Time: 500 hours		
Cold Resistance	Inductance value must remain within 20% of initial value. No disconnection or short circuit. No change in appearance.	Tested after 2 hours at room temperature		
		Temperature: -40±5°C		
		Time: 500 hours		
Thermal Shock	Inductance value must remain within 20% of initial value. No disconnection or short circuit. No change in appearance.	Tested after 2 hours at room temperature		
		One Cycle		
		Step	Temperature (°C)	Time (min.)
		1	-40±5°C	30
		2	Room Temperature	3
Humidity Resistance	Inductance value must remain within 20% of initial value. No disconnection or short circuit. No change in appearance.	3	30	
		4	Room Temperature	3
		Temperature: 40±2°C at 90~95% relative humidity .		
Vibration Test	Inductance value must remain within ±5% of initial value. No change in appearance	Time: 500 Hours		
		Tested after 2 hours at room temperature		
		After 1 hour of vibrations testing, in each of three orientations at 10Hz, then increase to 55Hz, then decrease to 10Hz with 1.52mm P-P amplitudes.		

# LMax Low Profile/High Current Power Inductor

## LMLP Series – Style D



### LMLP07A7M-R22

#### L&I Curve

R22

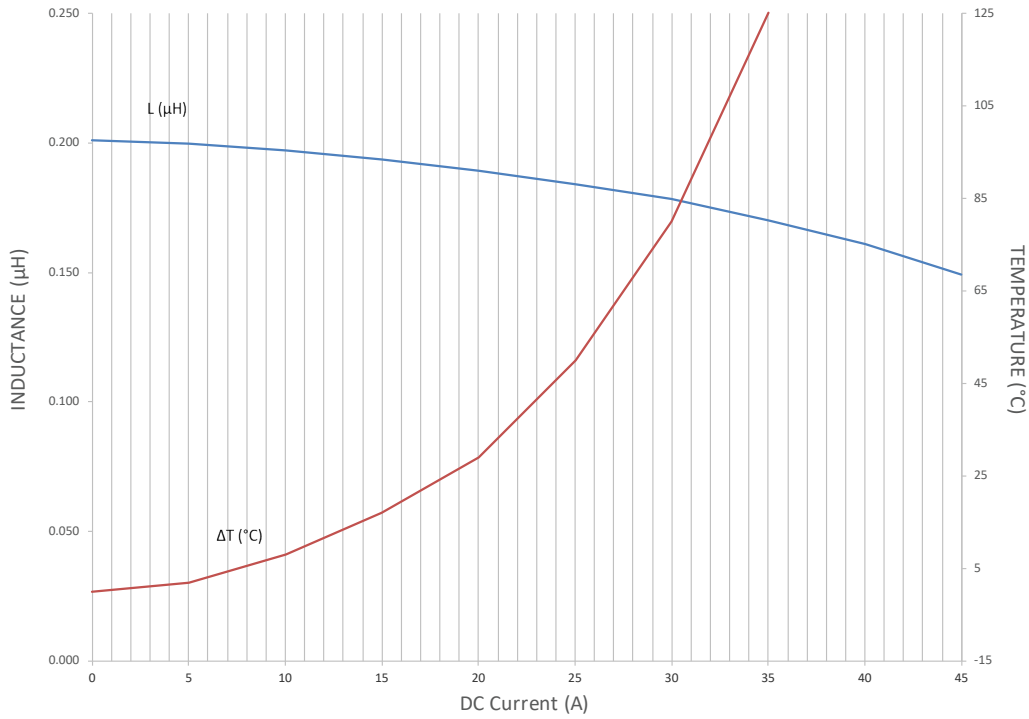

### LMLP07A7M-R33

#### L&I Curve

R33

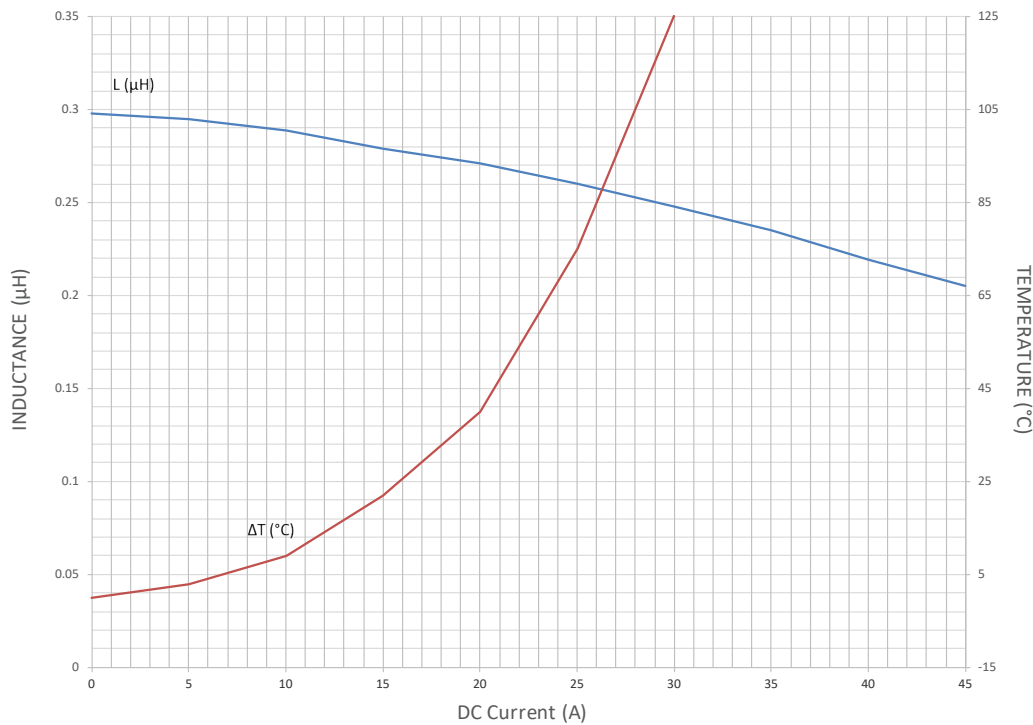

# LMax Low Profile/High Current Power Inductor

## LMLP Series – Style D



### LMLP07A7M-R47

#### L&I Curve

R47

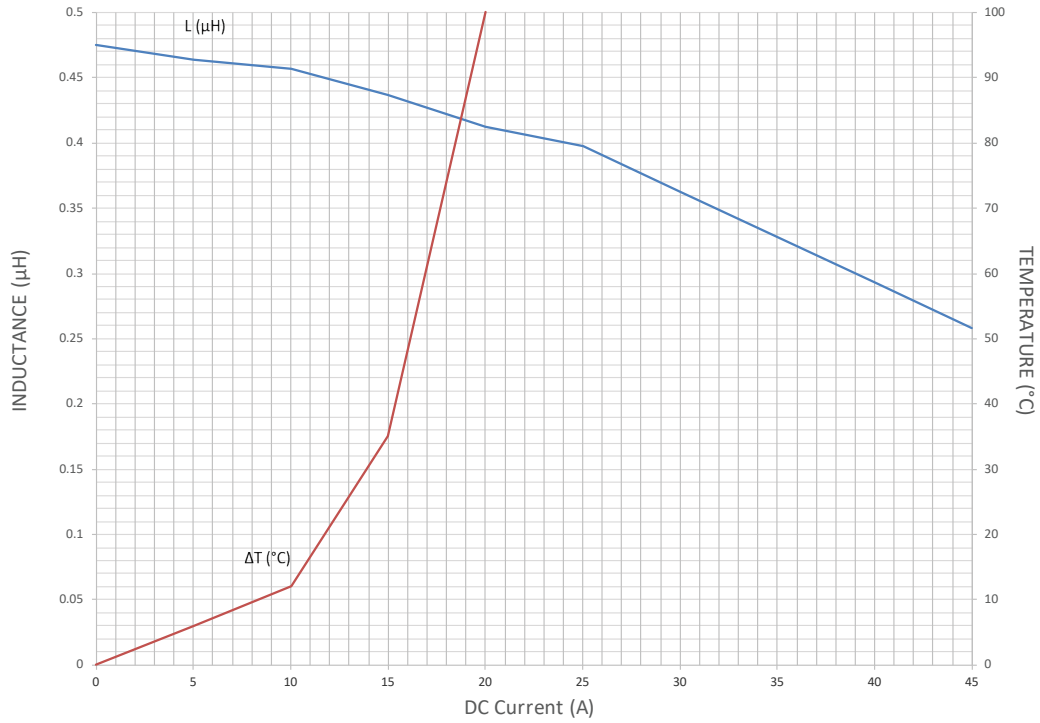

### LMLP07A7M-R68

#### L&I Curve

R68

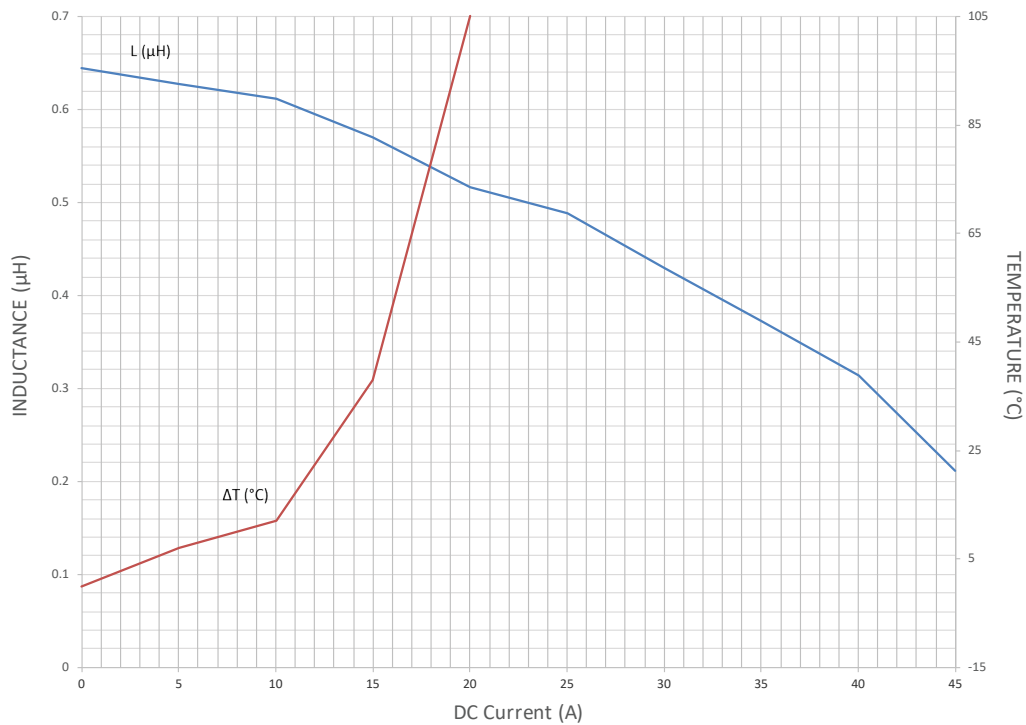

The Important Information/Disclaimer is incorporated in the catalog where these specifications came from or available online at [www.avx.com/disclaimer/](http://www.avx.com/disclaimer/) by reference and should be reviewed in full before placing any order.

# LMax Low Profile/High Current Power Inductor

## LMLP Series – Style D



### LMLP07A7M-R82

#### L&I Curve

R82

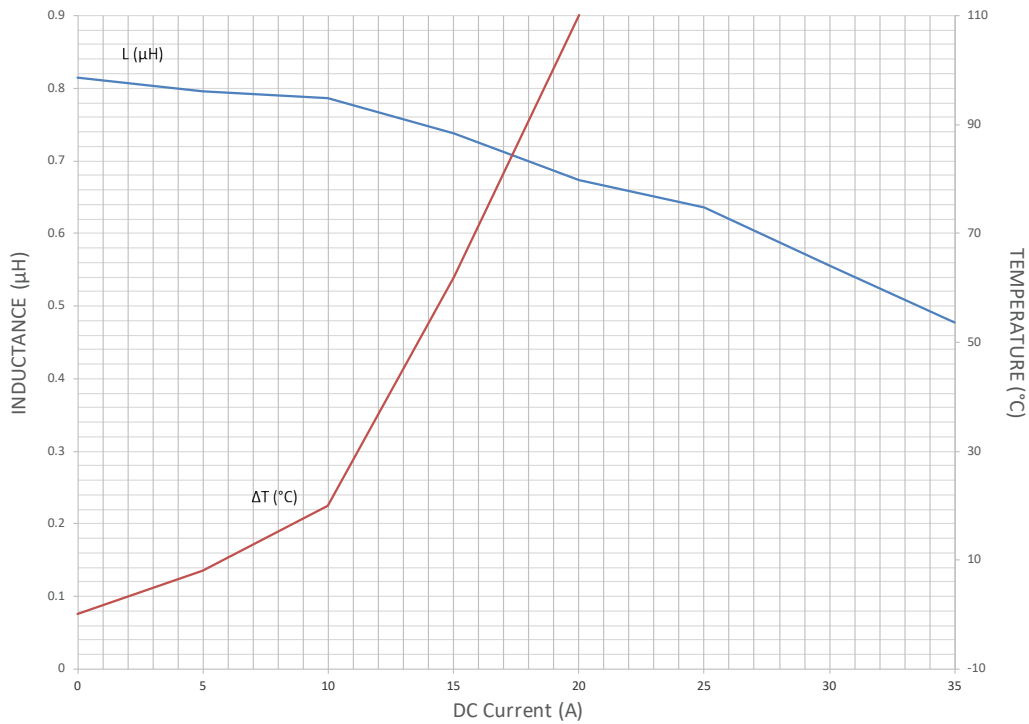

### LMLP07A7M-1R0

#### L&I Curve

1R0

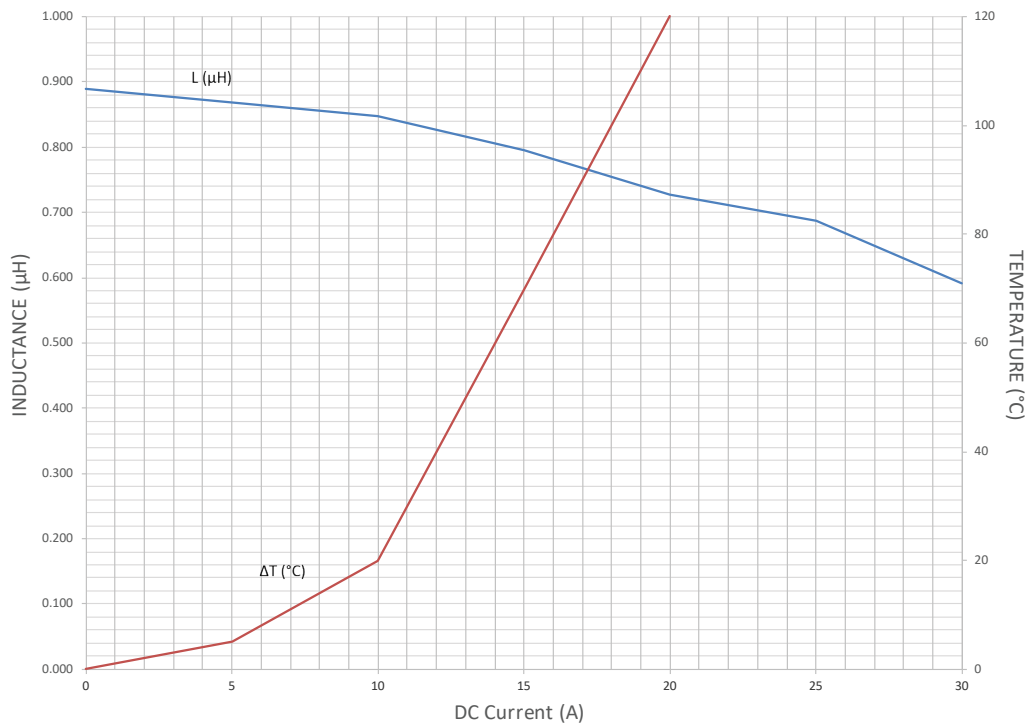

# LMax Low Profile/High Current Power Inductor

## LMLP Series – Style D



### LMLP07A7M-1R5

#### L&I Curve

1R5

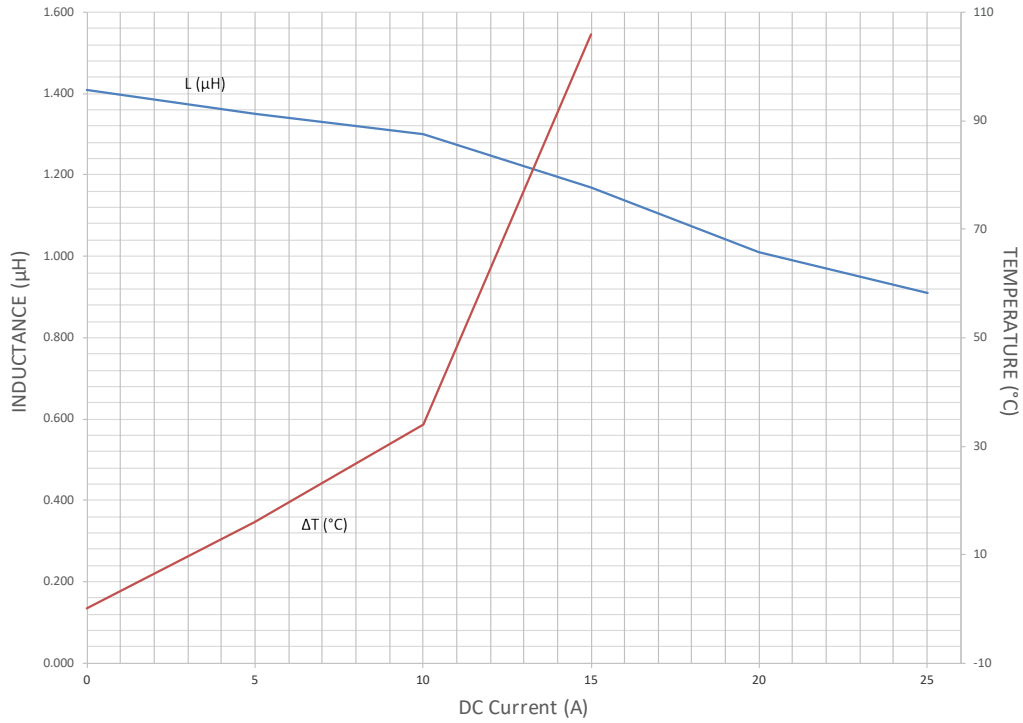

### LMLP07A7M-2R2

#### L&I Curve

2R2

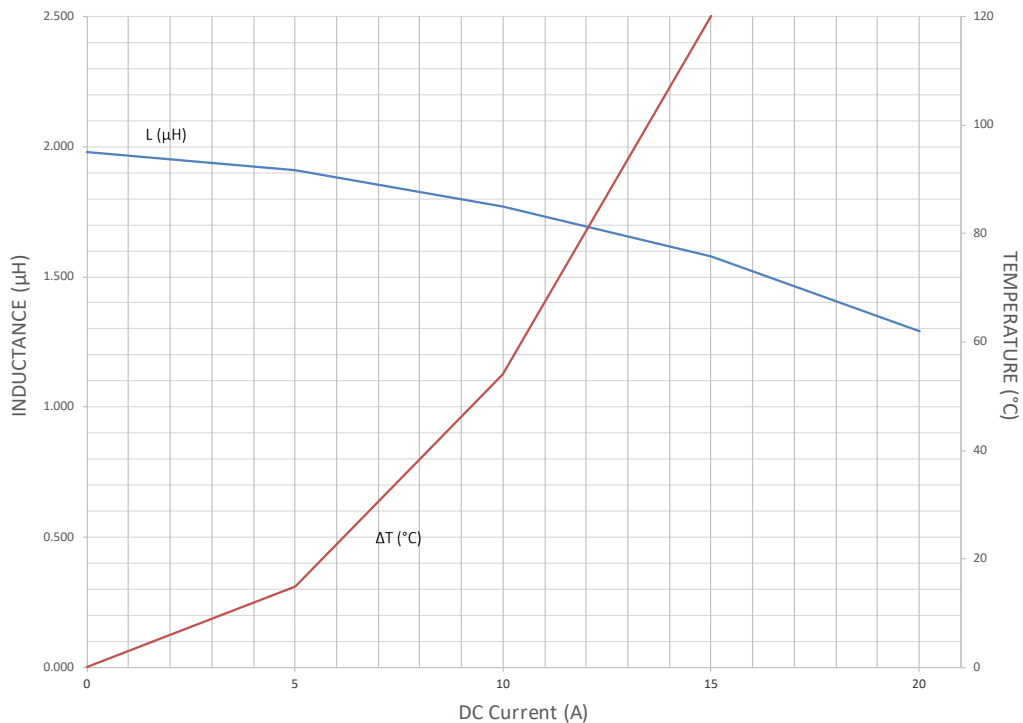

The Important Information/Disclaimer is incorporated in the catalog where these specifications came from or available online at [www.avx.com/disclaimer/](http://www.avx.com/disclaimer/) by reference and should be reviewed in full before placing any order.

# LMax Low Profile/High Current Power Inductor

## LMLP Series – Style D



### LMLP07A7M-3R3

#### L&I Curve

3R3

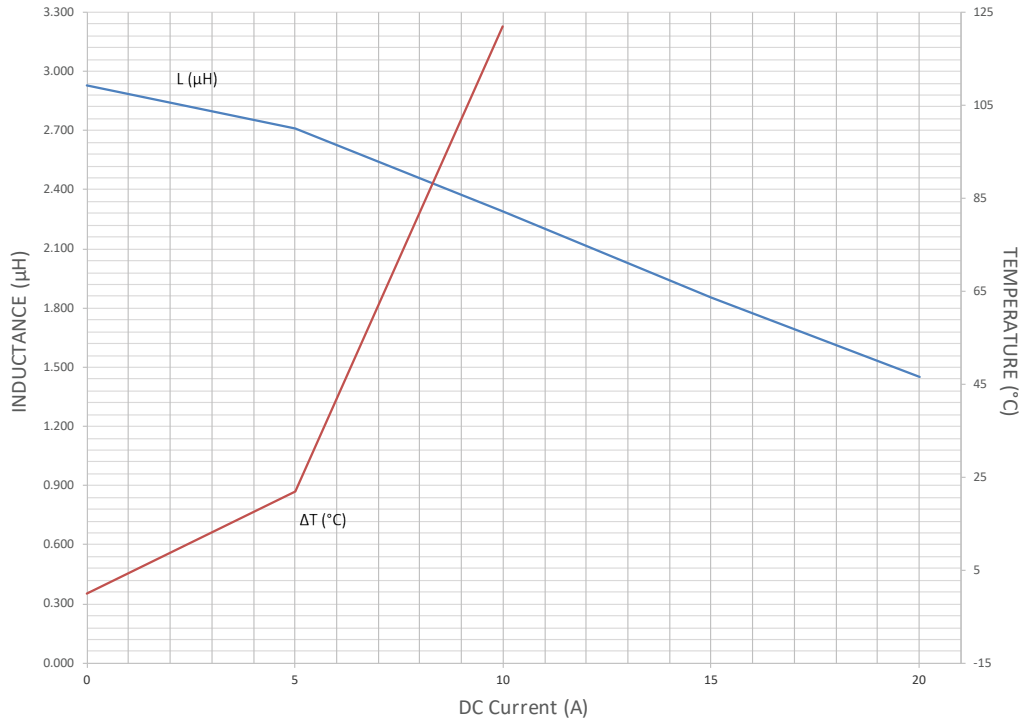

### LMLP07A7M-4R7

#### L&I Curve

4R7

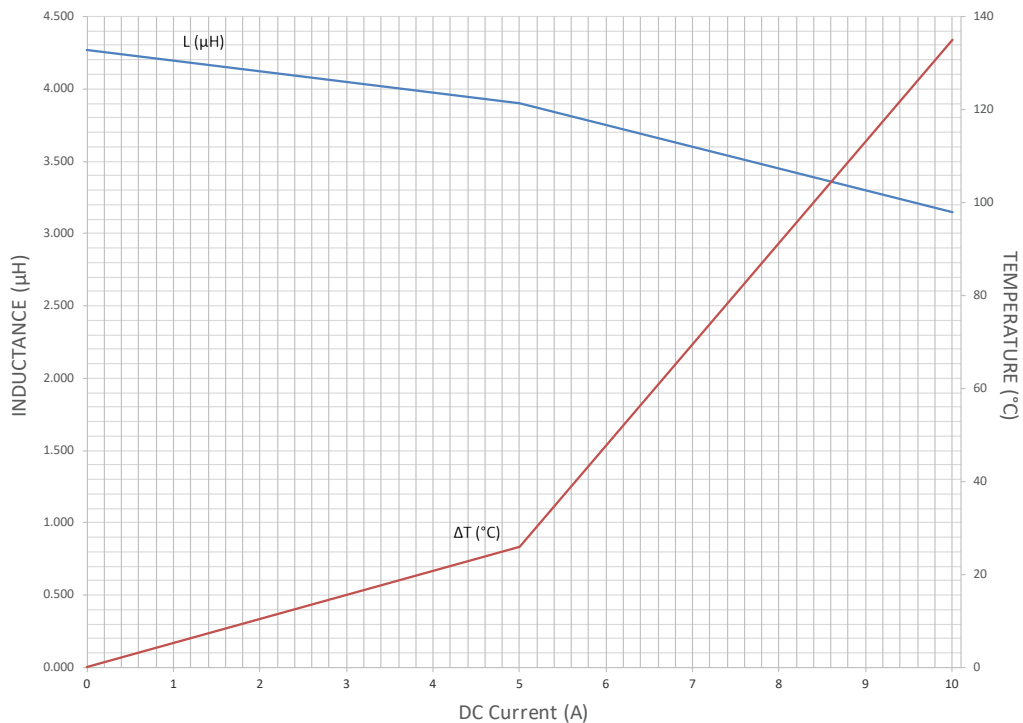

# LMax Low Profile/High Current Power Inductor

## LMLP Series – Style D



### LMLP07A7M-6R8

#### L&I Curve

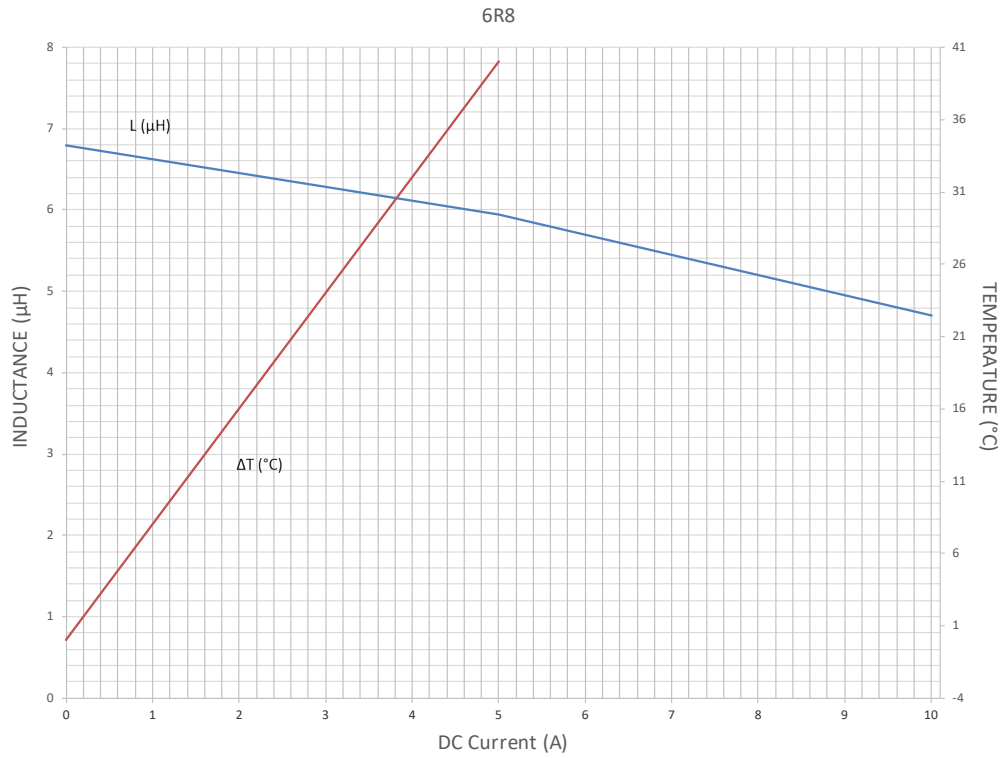

### LMLP07A7M-8R2

#### L&I Curve

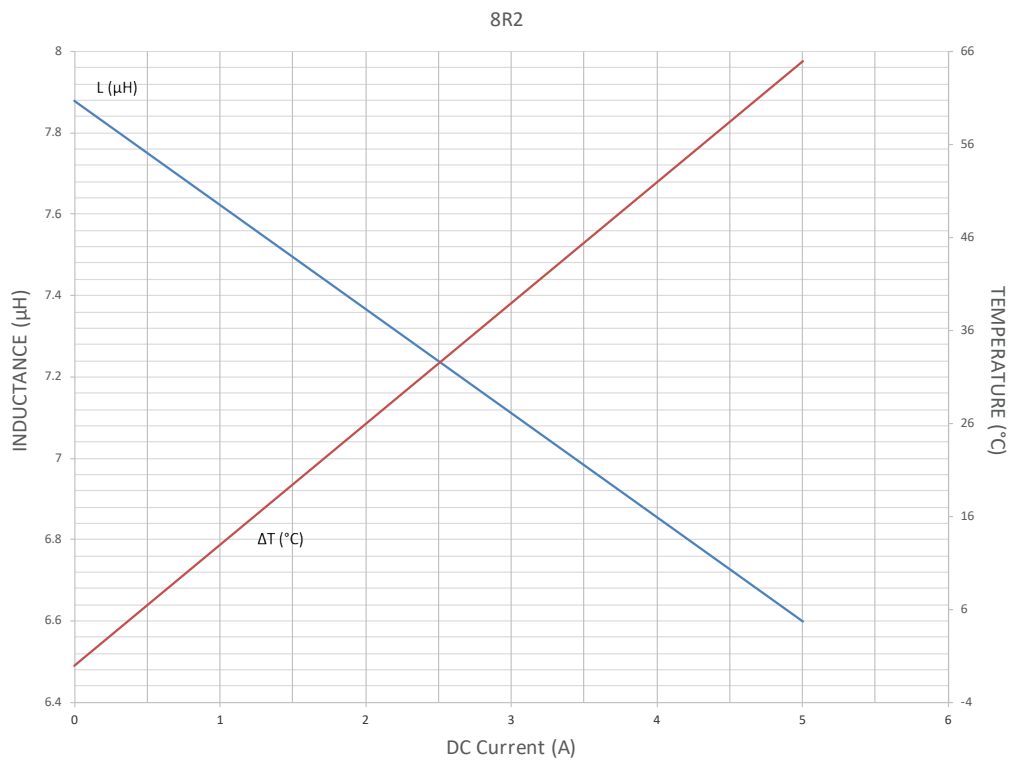

The Important Information/Disclaimer is incorporated in the catalog where these specifications came from or available online at [www.avx.com/disclaimer/](http://www.avx.com/disclaimer/) by reference and should be reviewed in full before placing any order.



# LMax Low Profile/High Current Power Inductor

## LMLP Series – Style D



### LMLP07A7M-100

#### L&I Curve

100

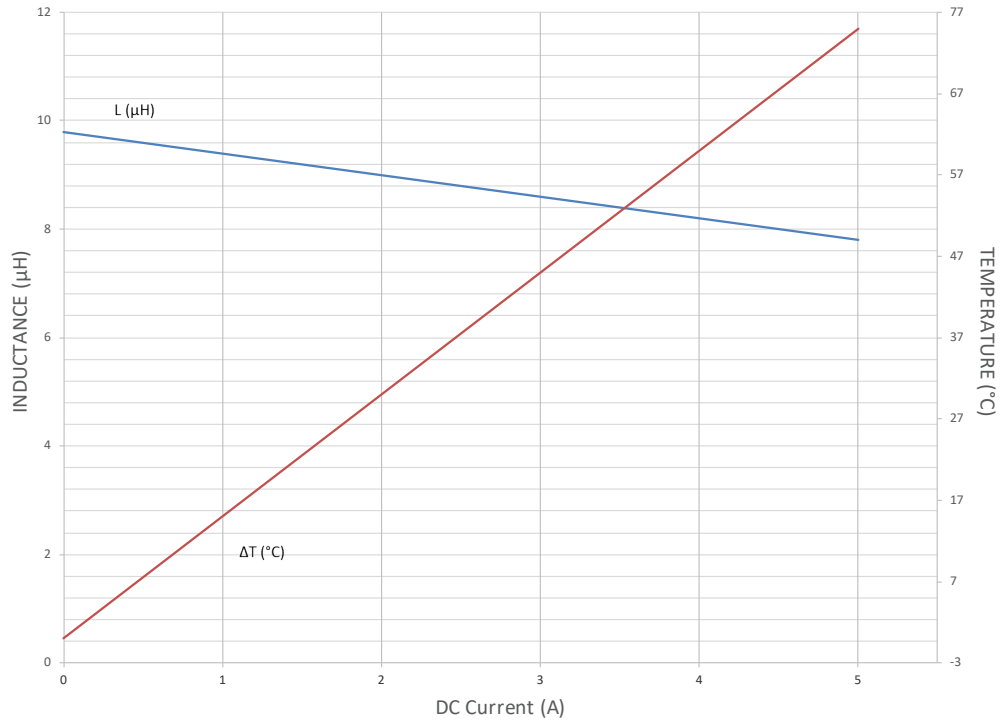

### LMLP07A7M-R22

#### I&T Curve

R22

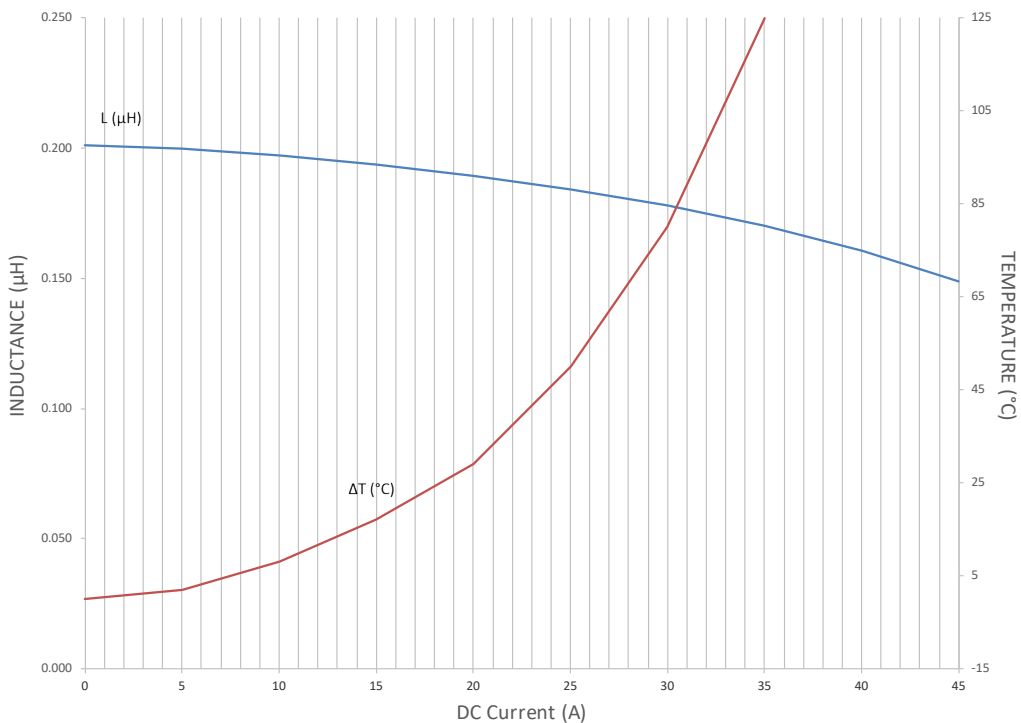

# LMax Low Profile/High Current Power Inductor

## LMLP Series – Style D



### LMLP07A7M-R33

#### I&T Curve

R33

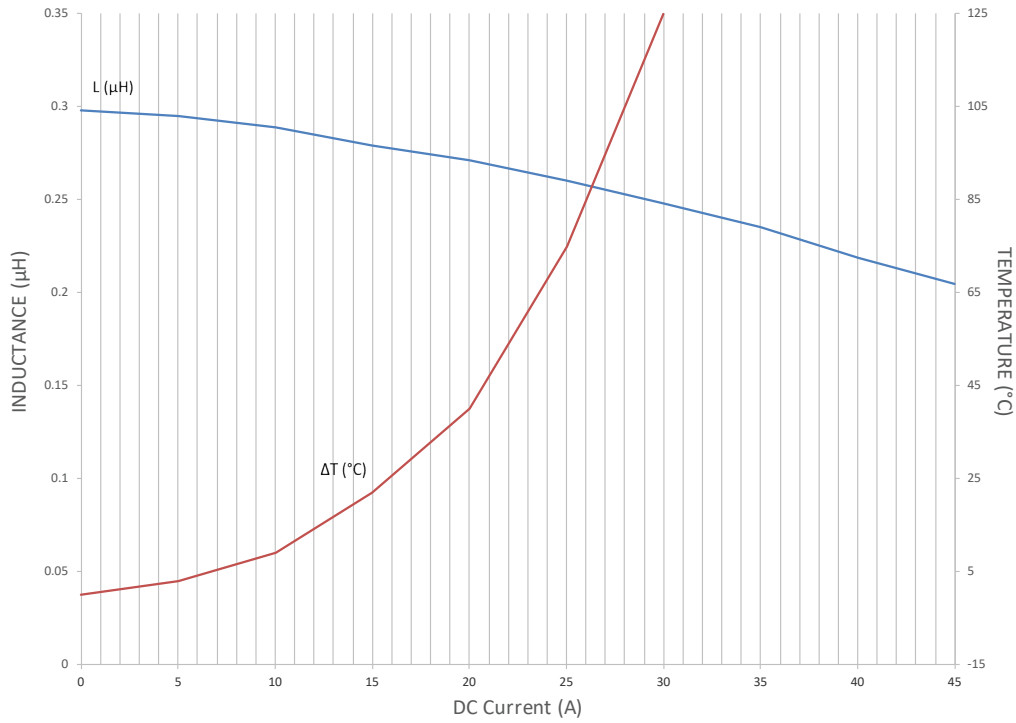

### LMLP07A7M-R47

#### I&T Curve

R47

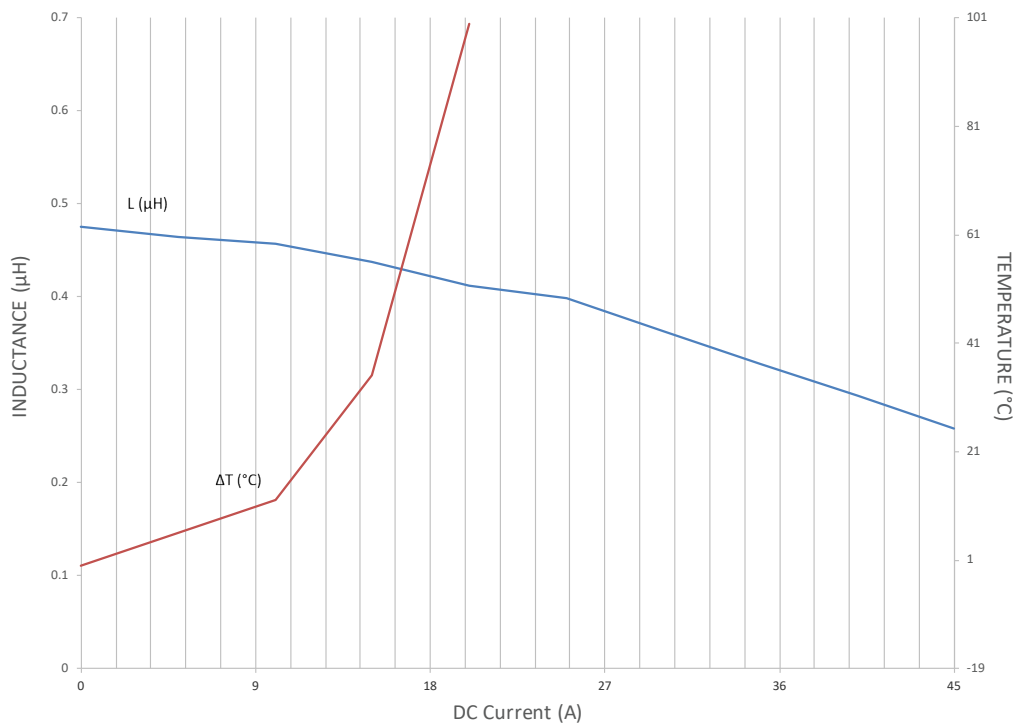

The Important Information/Disclaimer is incorporated in the catalog where these specifications came from or available online at [www.avx.com/disclaimer/](http://www.avx.com/disclaimer/) by reference and should be reviewed in full before placing any order.

# LMax Low Profile/High Current Power Inductor

## LMLP Series – Style D



### LMLP07A7M-R68

#### I&T Curve

R68

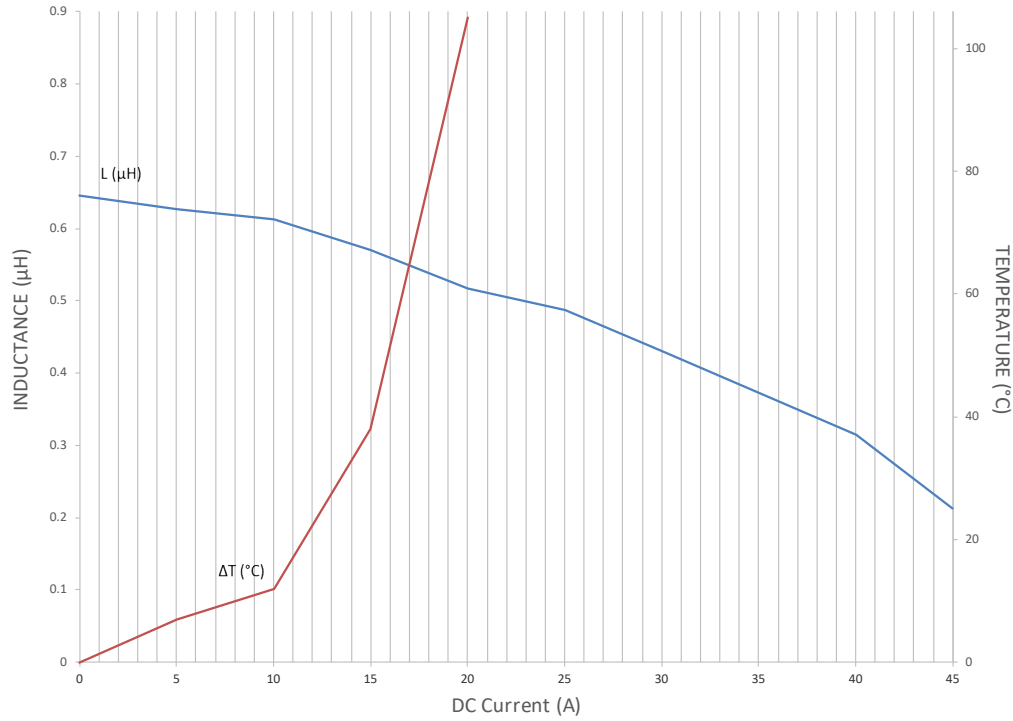

### LMLP07A7M-R82

#### I&T Curve

R82

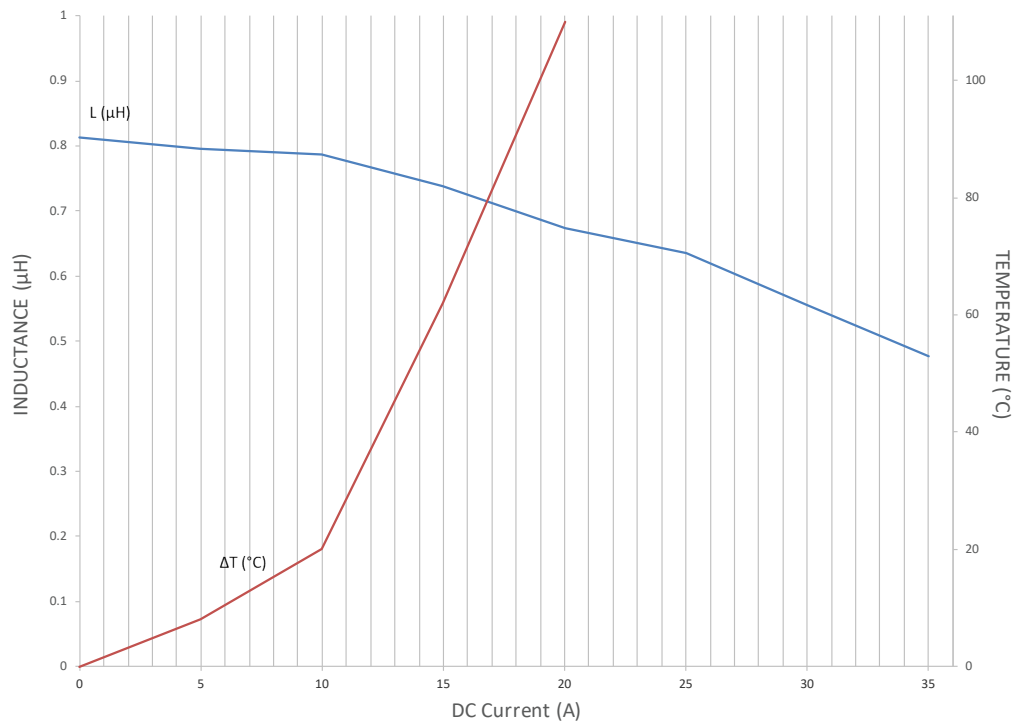

# LMax Low Profile/High Current Power Inductor

## LMLP Series – Style D



### LMLP07A7M-1R0

#### I&T Curve

1R0

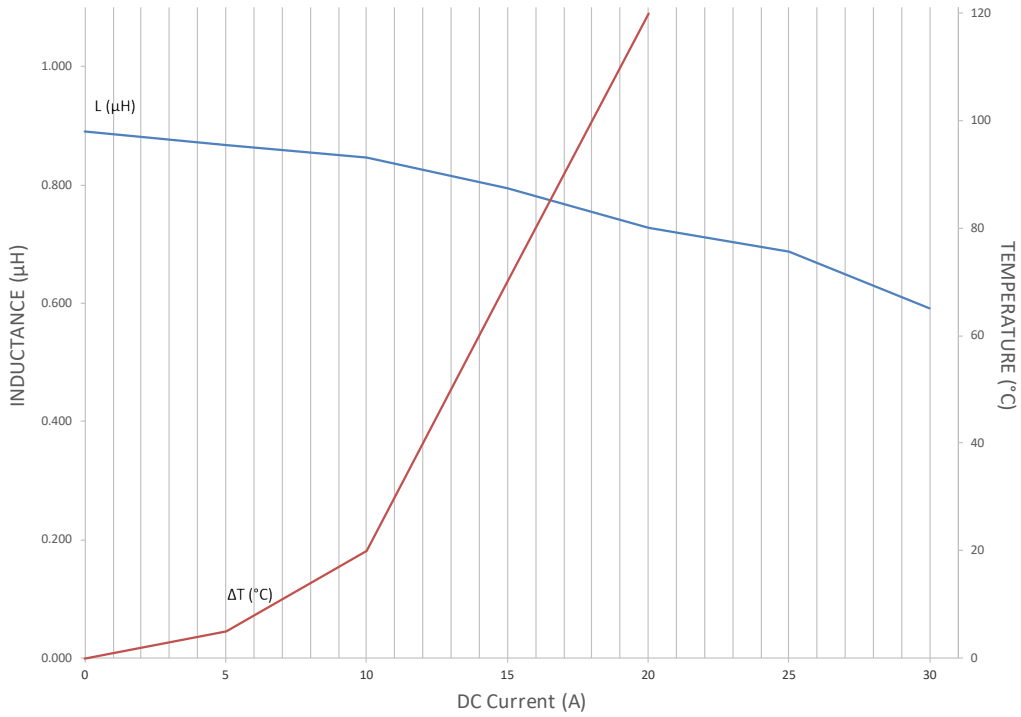

### LMLP07A7M-1R5

#### I&T Curve

1R5

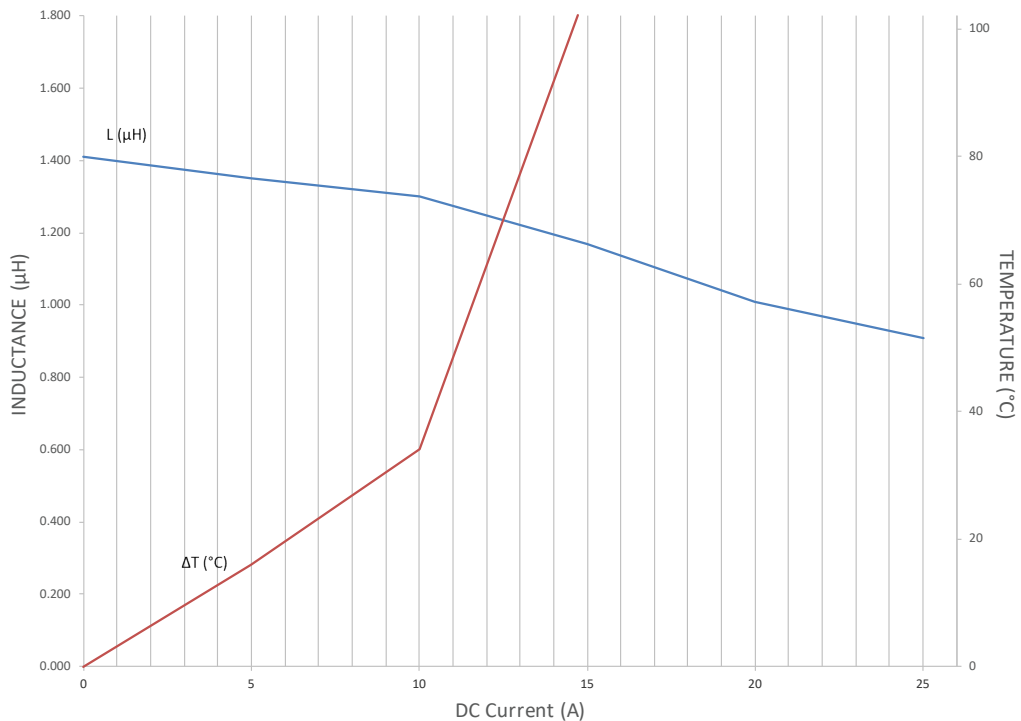

The Important Information/Disclaimer is incorporated in the catalog where these specifications came from or available online at [www.avx.com/disclaimer/](http://www.avx.com/disclaimer/) by reference and should be reviewed in full before placing any order.

# LMax Low Profile/High Current Power Inductor

## LMLP Series – Style D



### LMLP07A7M-2R2

#### I&T Curve

2R2

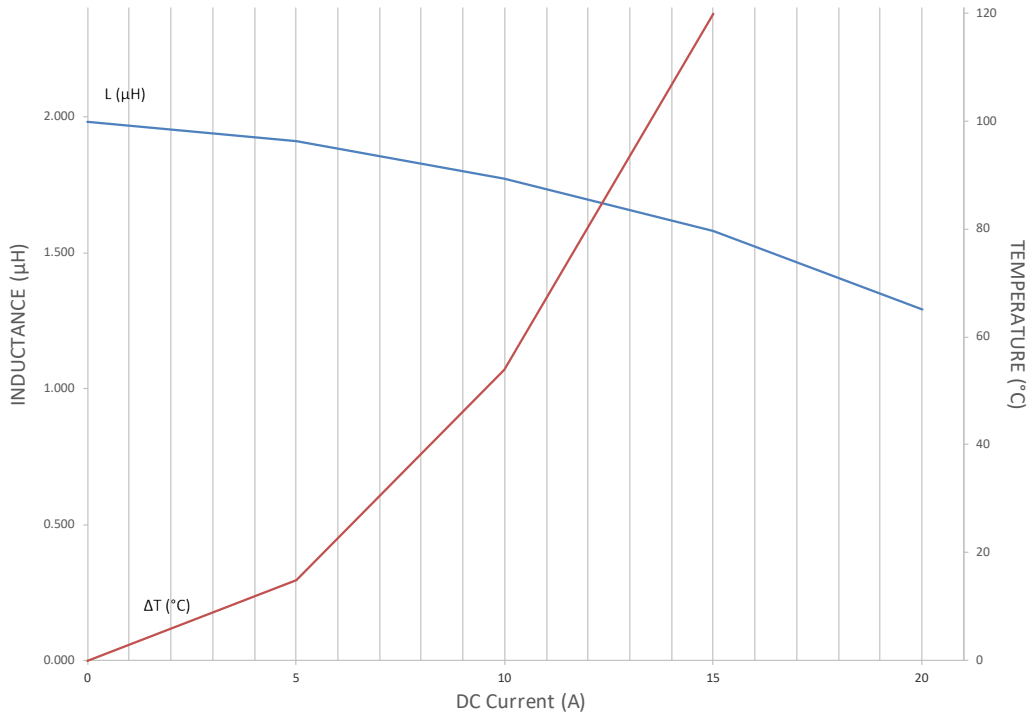

### LMLP07A7M-3R3

#### I&T Curve

3R3

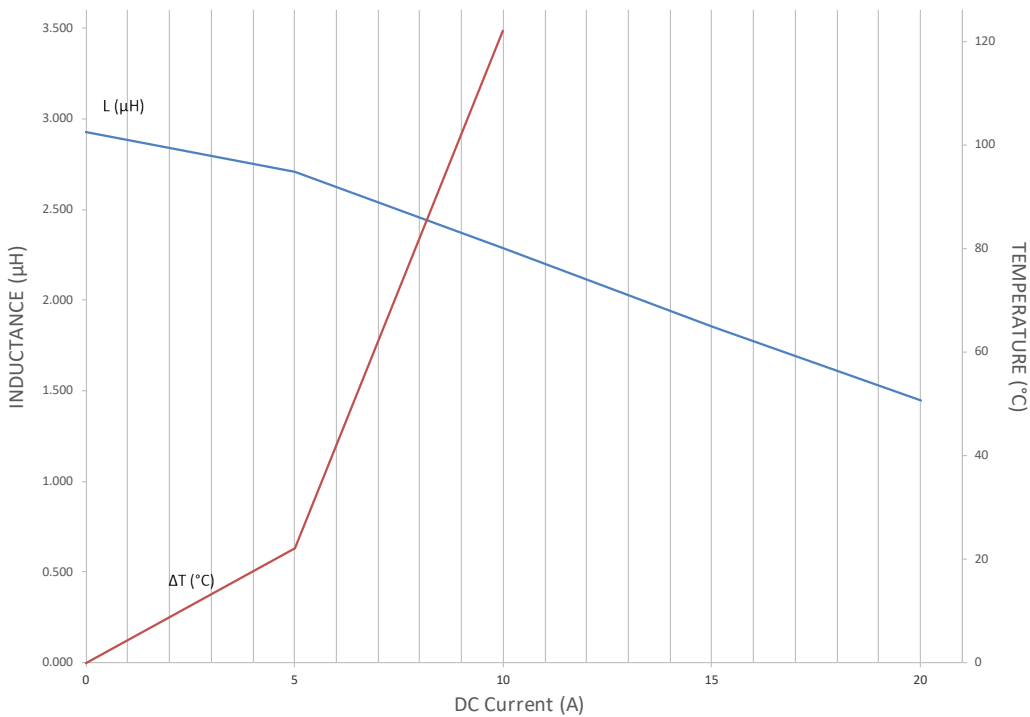

# LMax Low Profile/High Current Power Inductor

## LMLP Series – Style D



### LMLP07A7M-4R7

#### I&T Curve

4R7

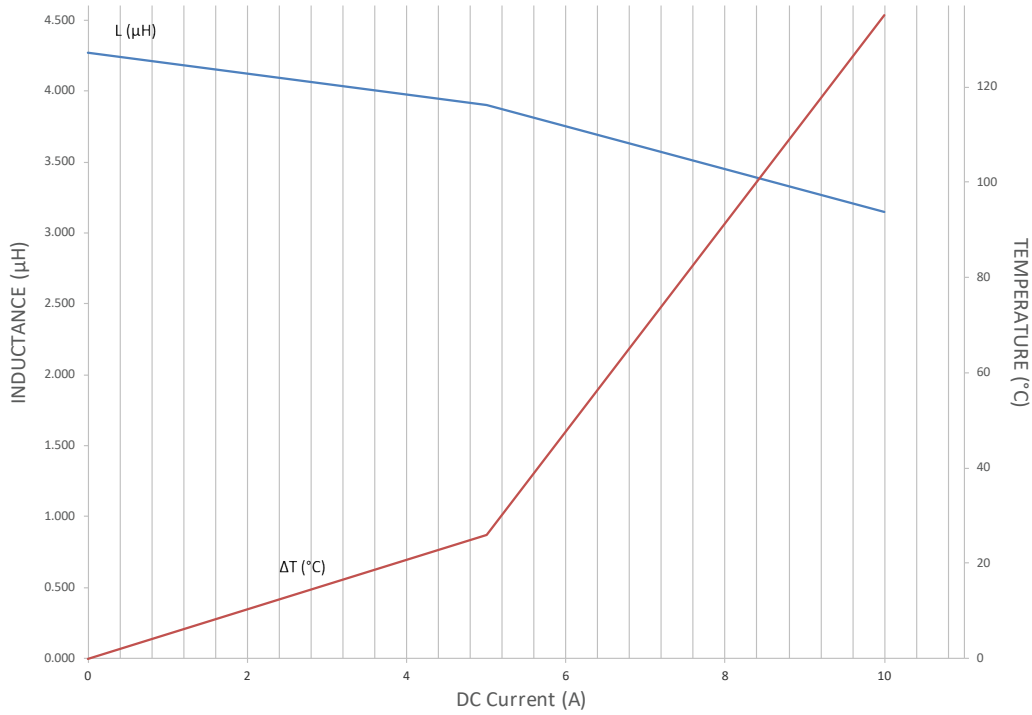

### LMLP07A7M-6R8

#### I&T Curve

6R8

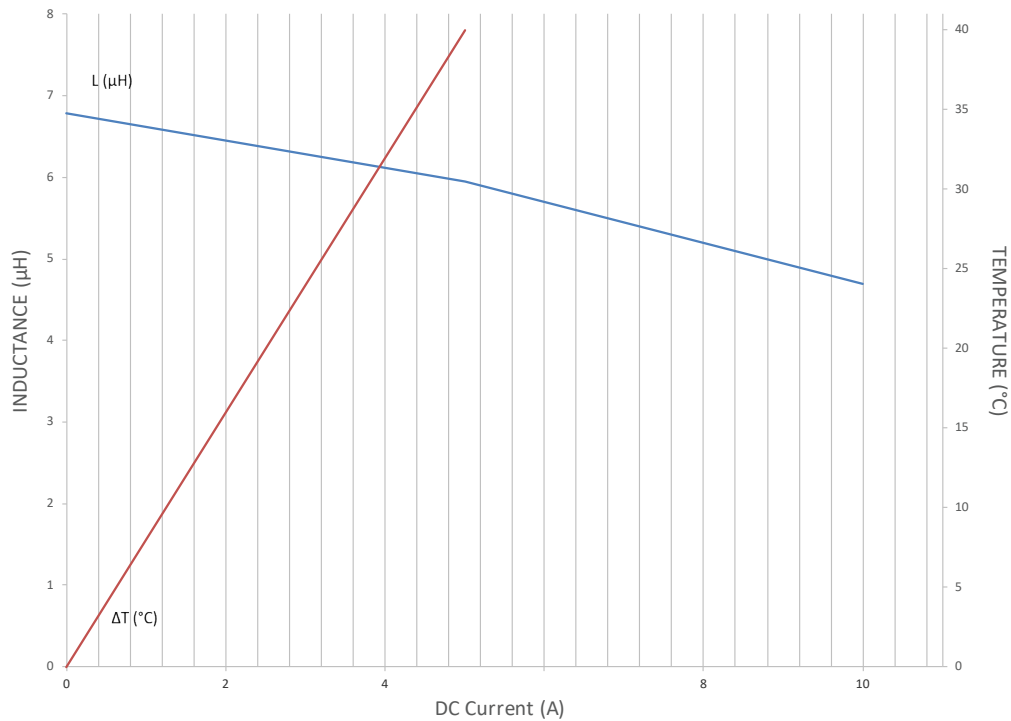

# LMax Low Profile/High Current Power Inductor

## LMLP Series – Style D



### LMLP07A7M-8R2

#### I&T Curve

8R2

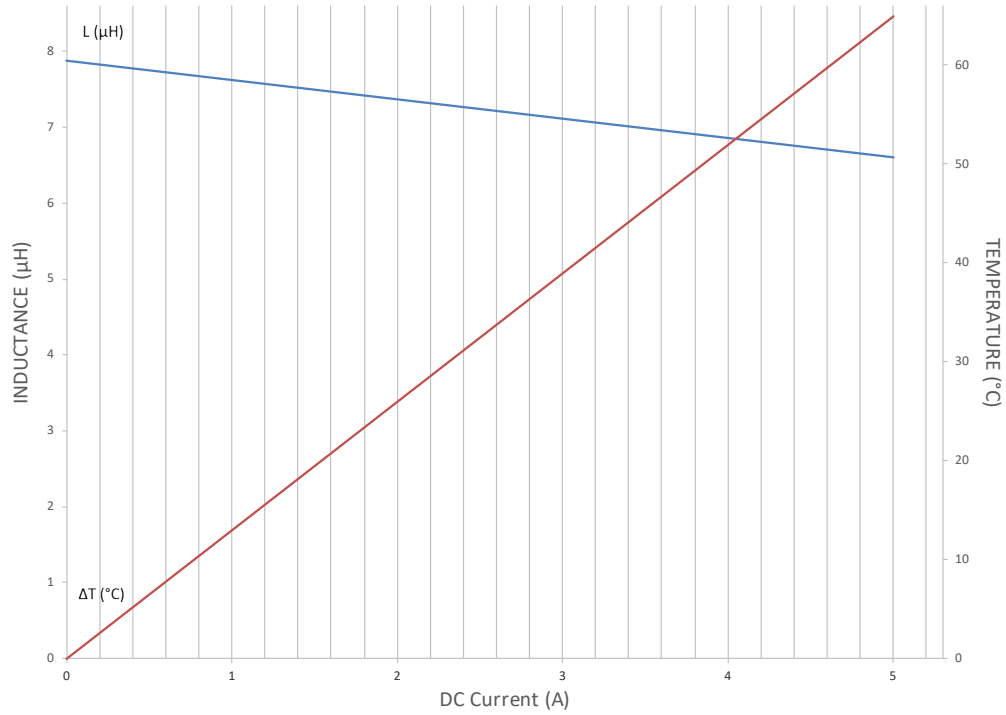

### LMLP07A7M-100

#### I&T Curve

100

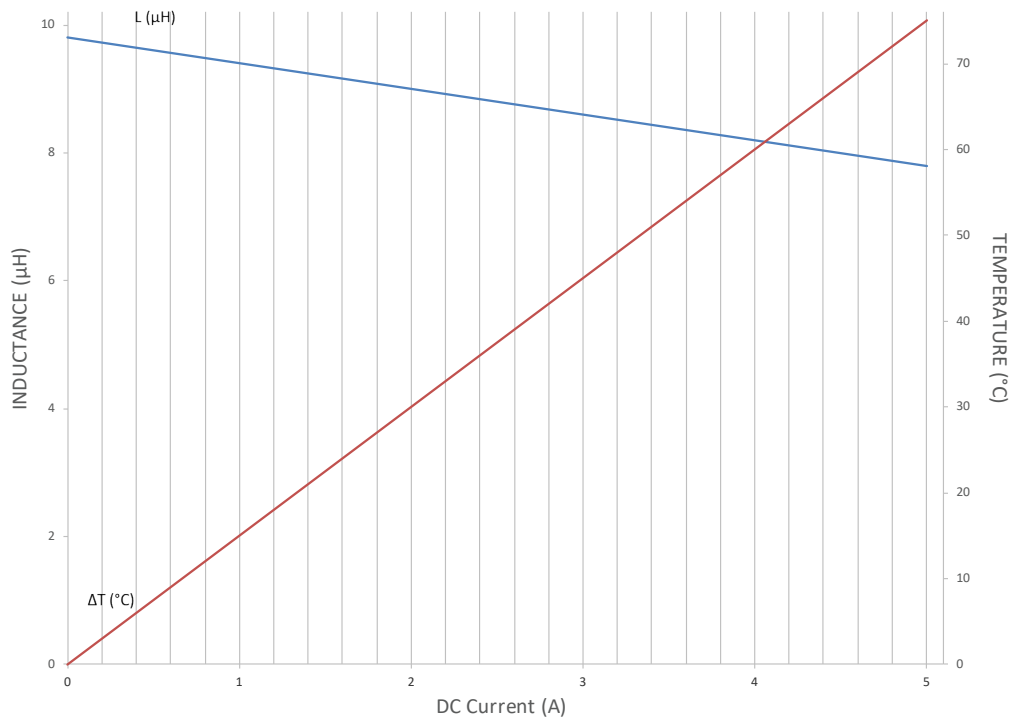

# LMax Low Profile/High Current Power Inductor

## LMLP Series – Style D



### LMLP1011M-R36

#### L&I Curve

R36

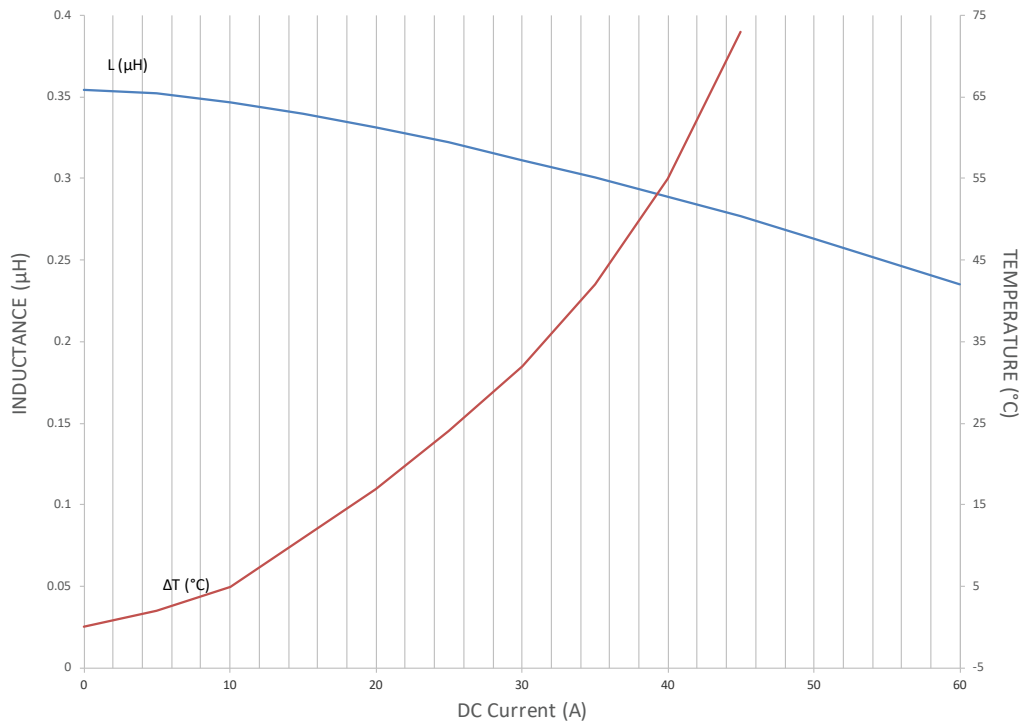

### LMLP1011M-R47

#### L&I Curve

R47

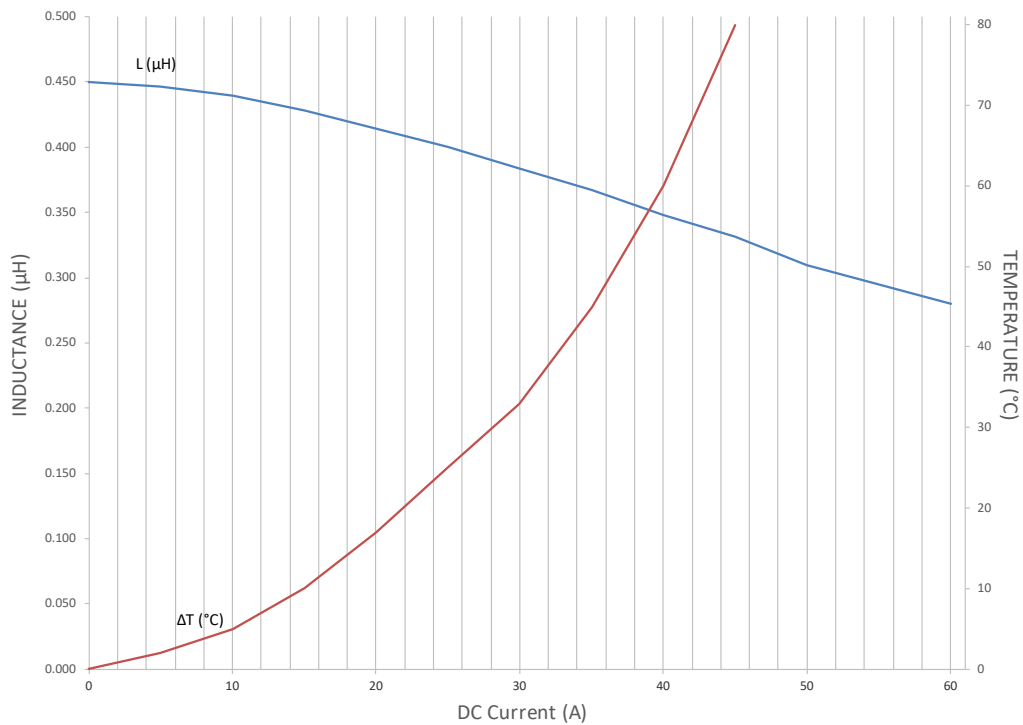

The Important Information/Disclaimer is incorporated in the catalog where these specifications came from or available online at [www.avx.com/disclaimer/](http://www.avx.com/disclaimer/) by reference and should be reviewed in full before placing any order.



# LMax Low Profile/High Current Power Inductor

## LMLP Series – Style D



### LMLP1011M-R56

#### L&I Curve

R56

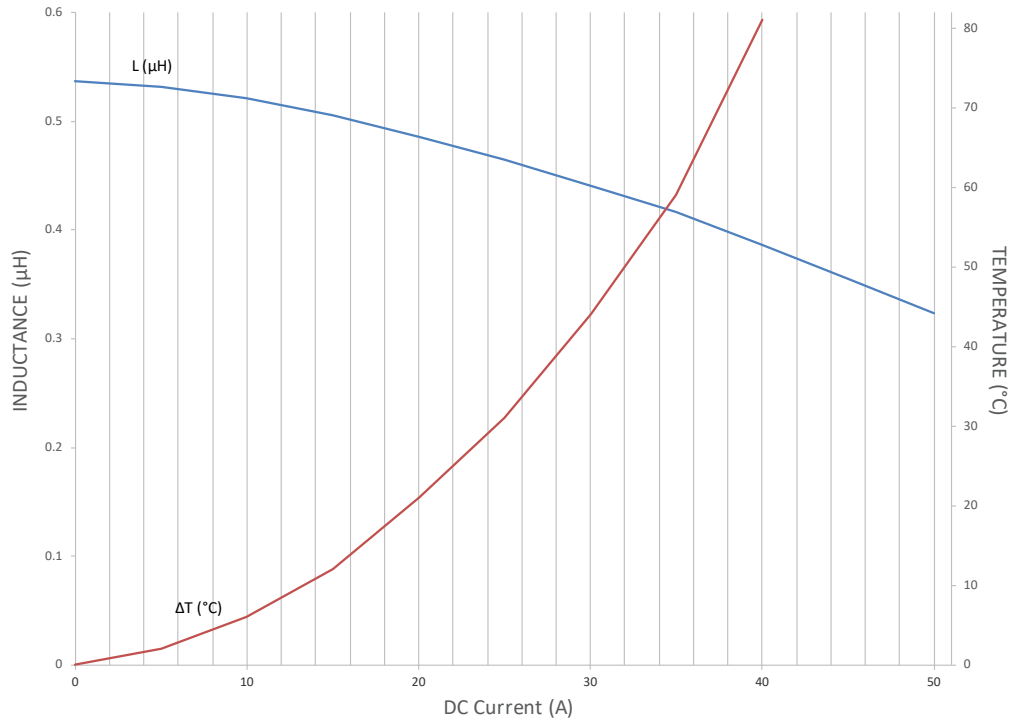

### LMLP1011M-R68

#### L&I Curve

R68

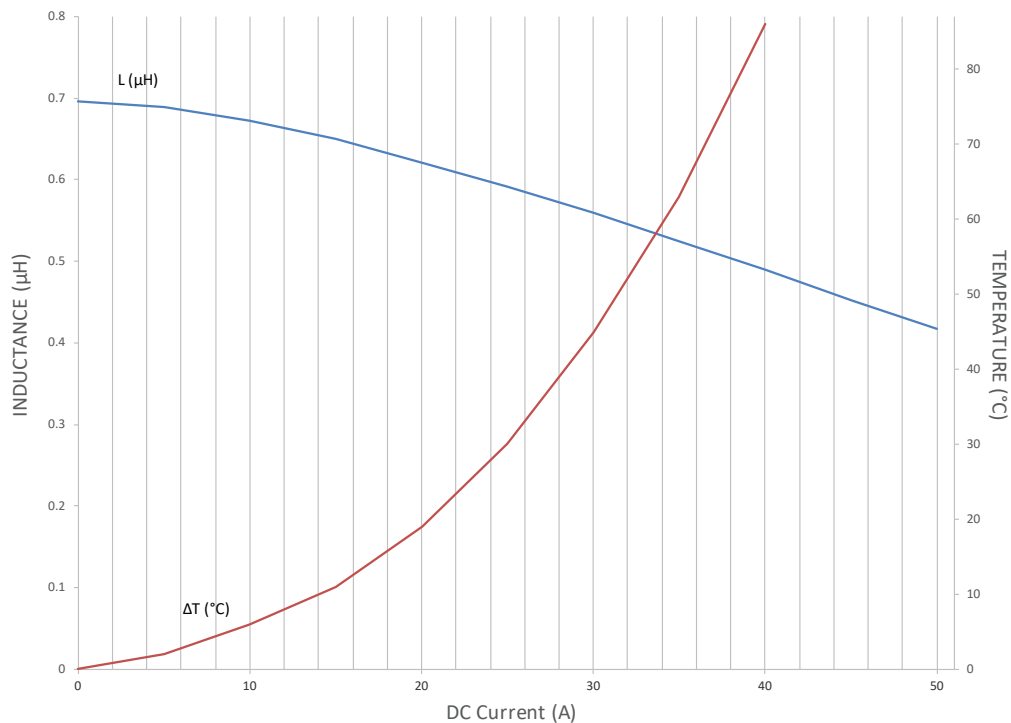

# LMax Low Profile/High Current Power Inductor

## LMLP Series – Style D



### LMLP1011M-1R0

#### L&I Curve

1R0

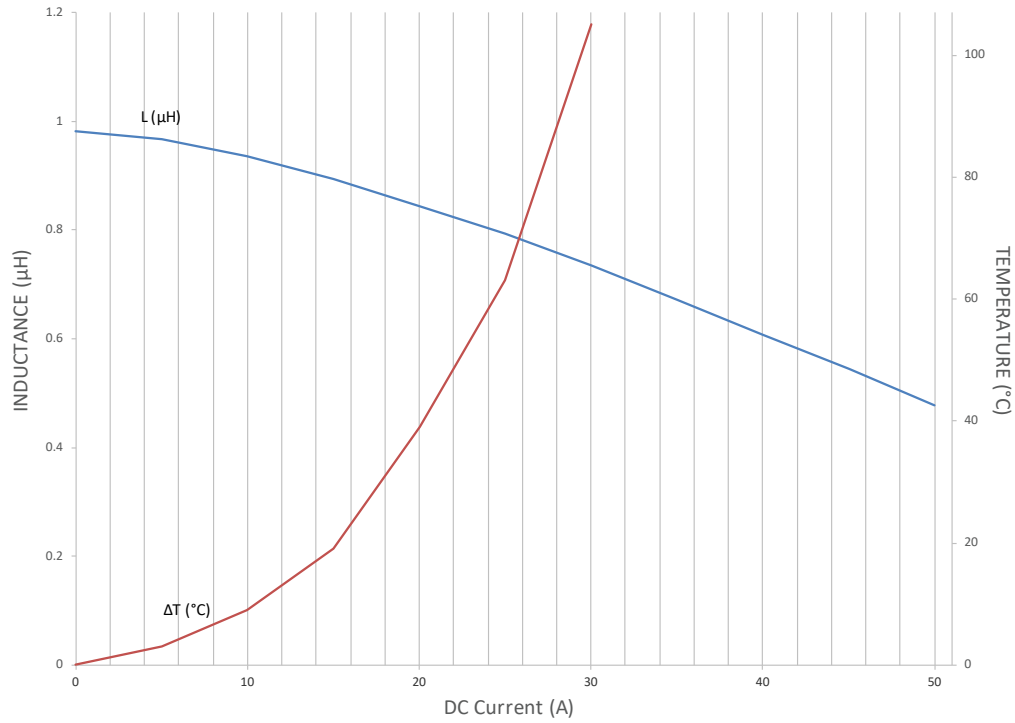

### LMLP1011M-1R5

#### L&I Curve

1R5

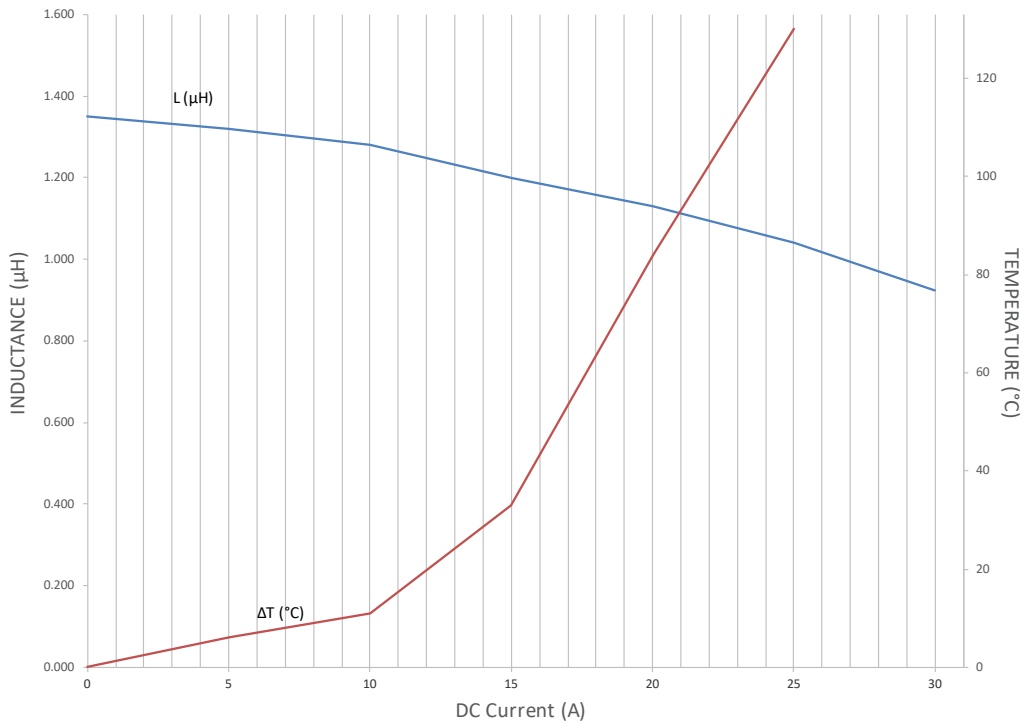

The Important Information/Disclaimer is incorporated in the catalog where these specifications came from or available online at [www.avx.com/disclaimer/](http://www.avx.com/disclaimer/) by reference and should be reviewed in full before placing any order.

# LMax Low Profile/High Current Power Inductor

## LMLP Series – Style D



### LMLP1011M-R36

#### I&T Curve

R36

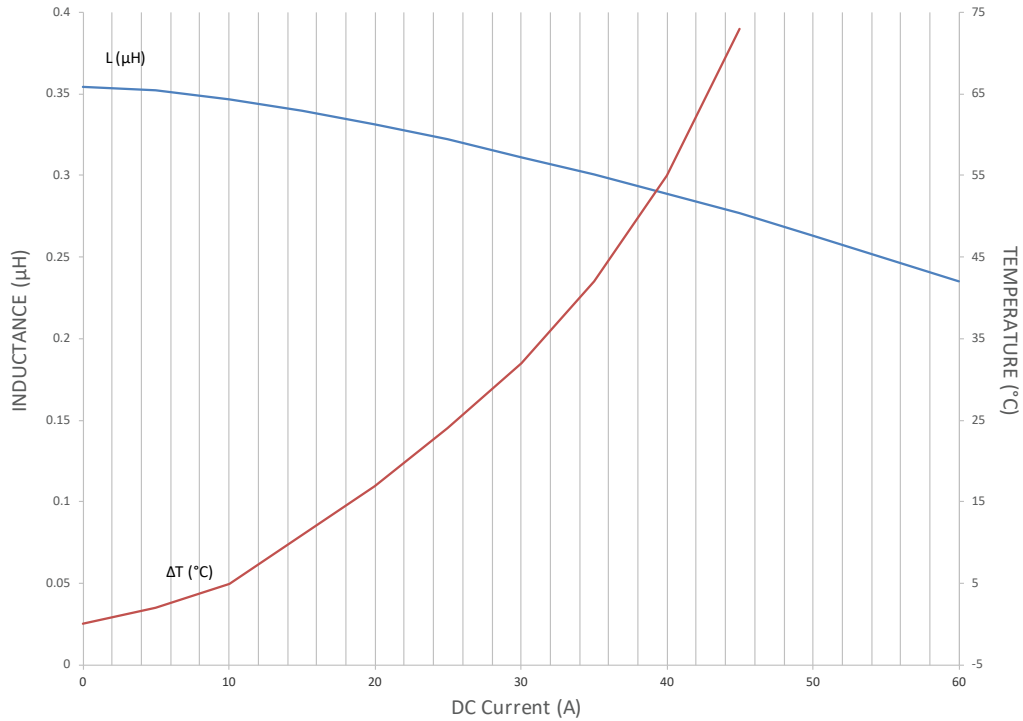

### LMLP1011M-R47

#### I&T Curve

R47

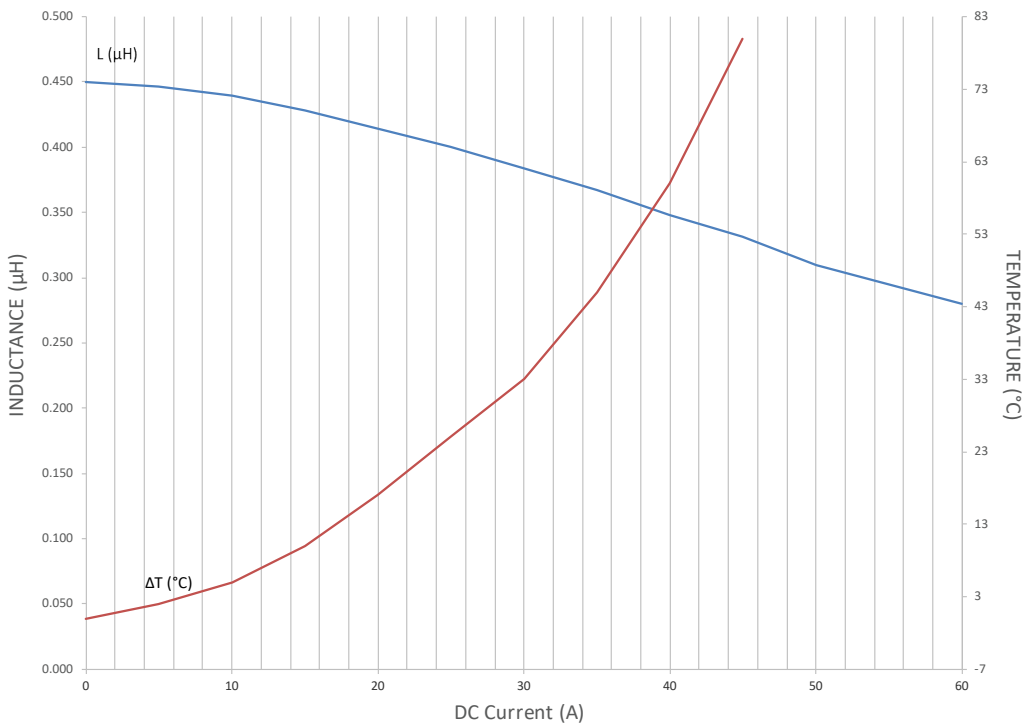

# LMax Low Profile/High Current Power Inductor

## LMLP Series – Style D



### LMLP1011M-R56

#### I&T Curve

R56

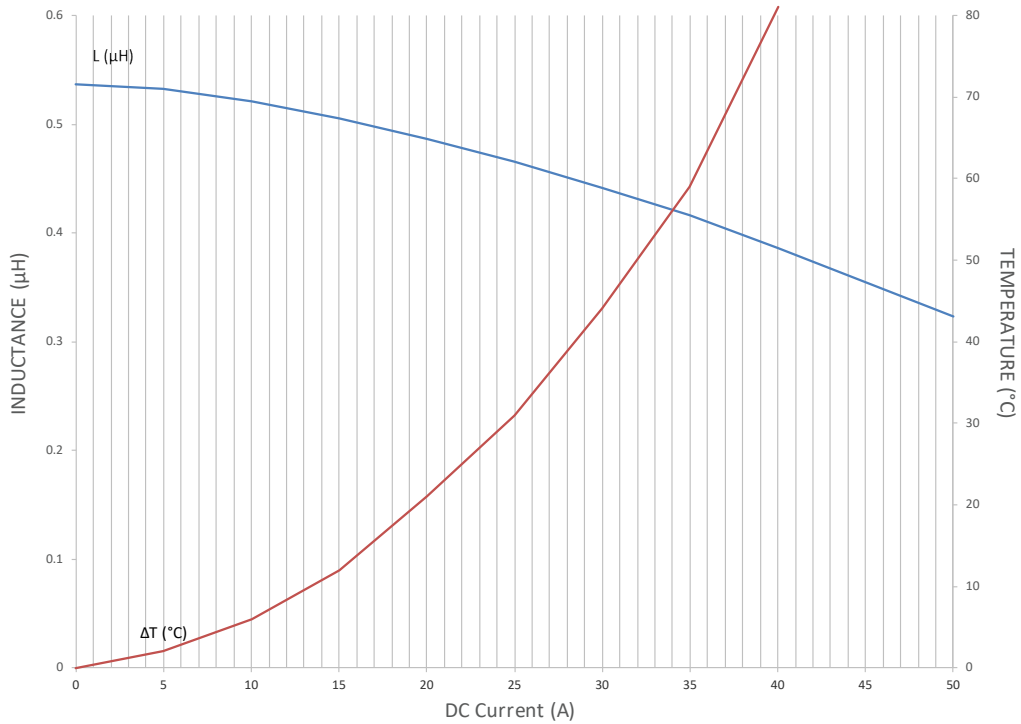

### LMLP1011M-R68

#### I&T Curve

R68

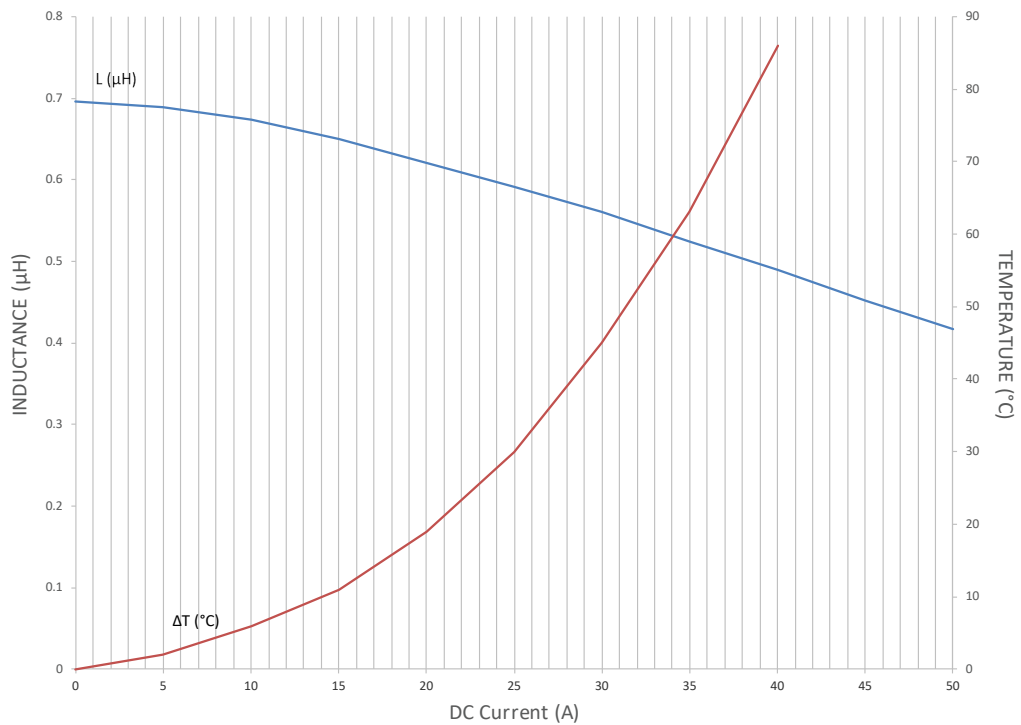

# LMax Low Profile/High Current Power Inductor

## LMLP Series – Style D



### LMLP1011M-1R0

#### I&T Curve

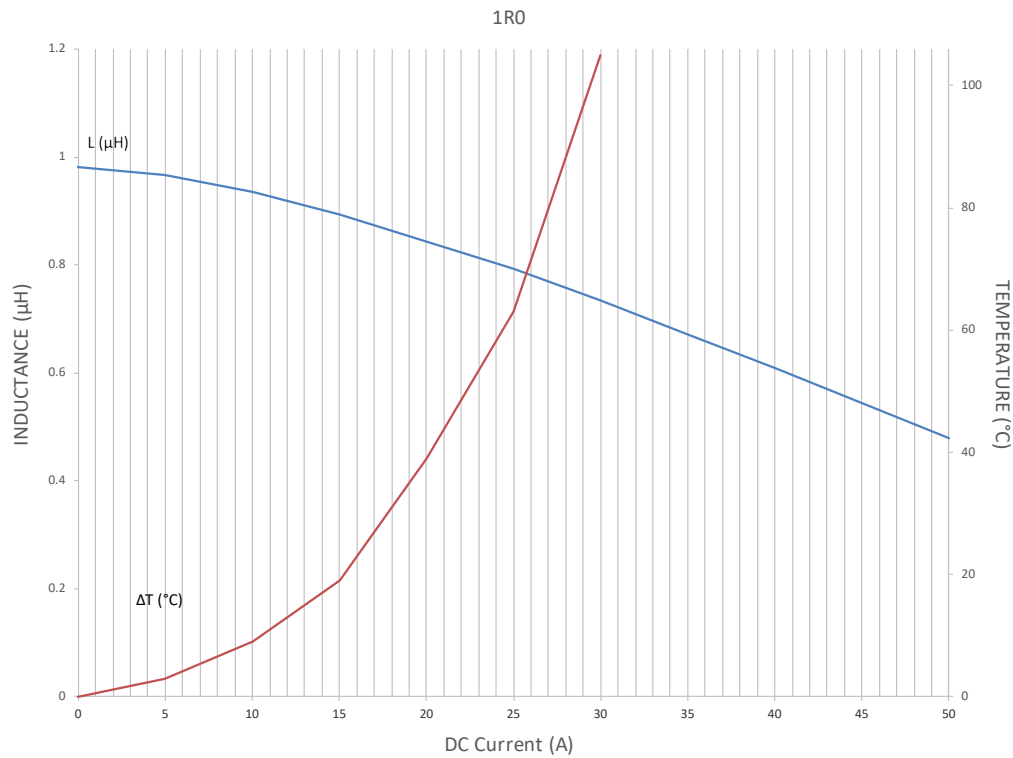

### LMLP1011M-1R5

#### I&T Curve

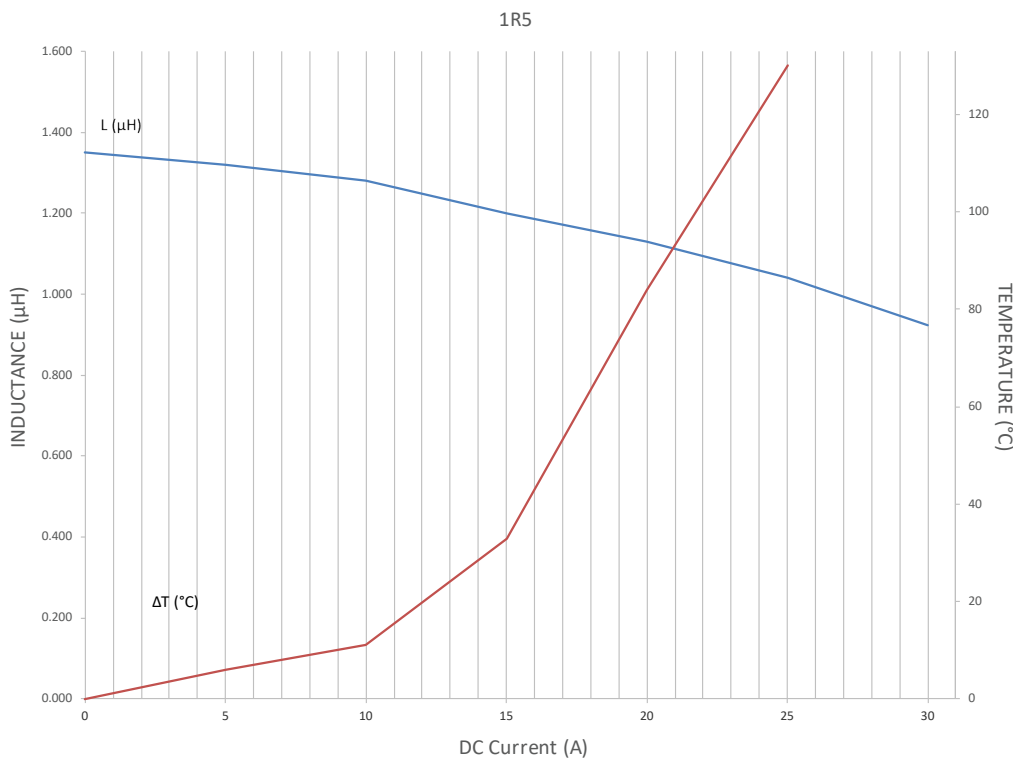

# LMax Low Profile/High Current Power Inductor

## LMLP Series – Style D

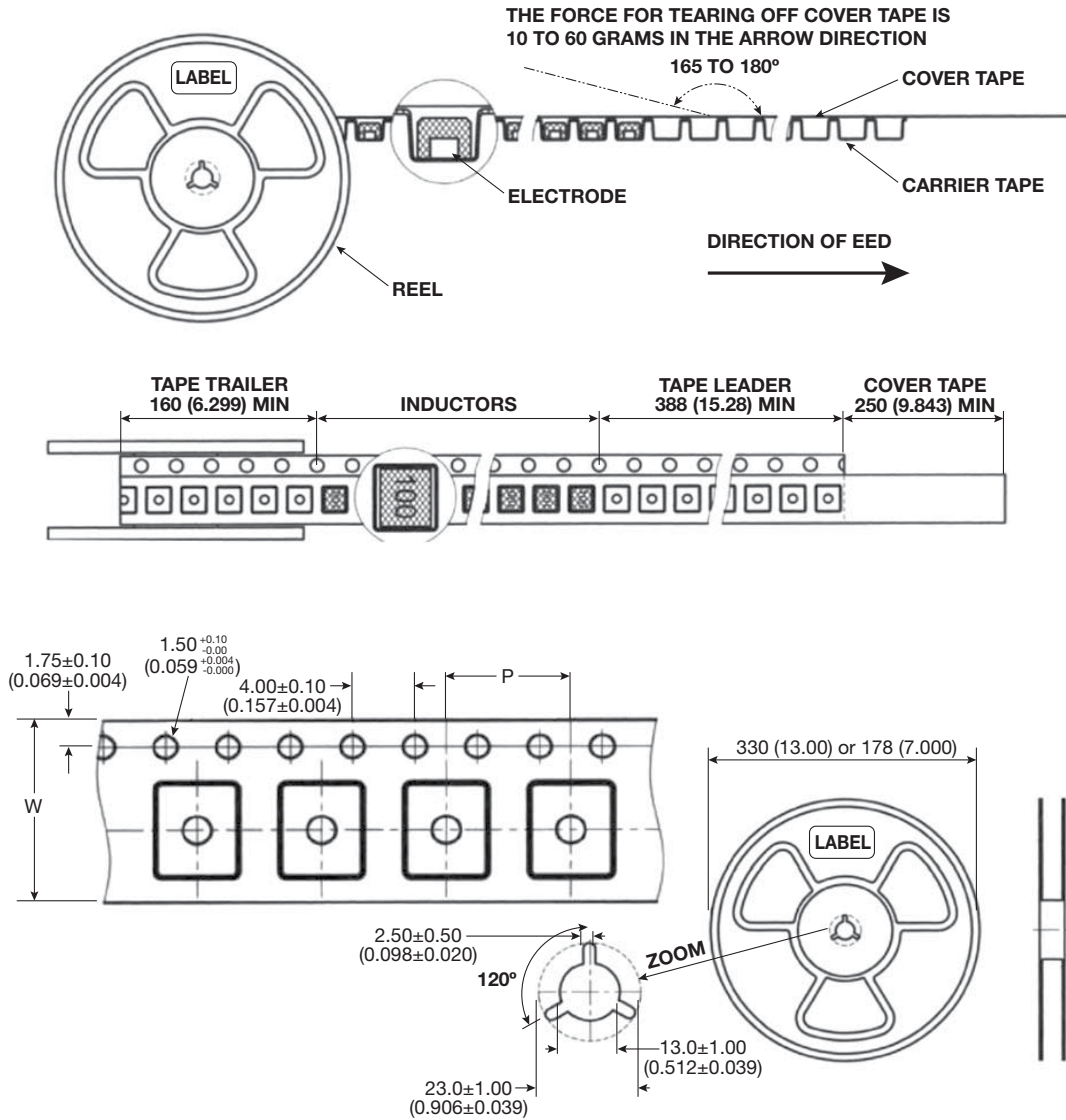

Size Code	Tape Size (mm)		Reel Size	SPQ
	W	P		
0405	12	8	13" Reel	2000
05A6	12	8	13" Reel	3000
0506	12	8	13" Reel	2000
0707	16	12	13" Reel	1500
07B7	16	12	13" Reel	1500
07A7	16	12	13" Reel	1000
07C7	16	12	13" Reel	800
1011	24	16	13" Reel	500
1313	24	16	13" Reel	500
13B3	24	20	13" Reel	400

**FOLLOW US:**     

VISIT US AT [WWW.AVX.COM](http://WWW.AVX.COM) 

**North America**

Tel: +1 864-967-2150

**Europe**

Tel: +44 1276-697000

**Asia**

Tel: +65 6286-7555

**Central America**

Tel: +55 11-46881960

**Japan**

Tel: +81 740-321250

单击下面可查看定价，库存，交付和生命周期等信息

[>>AVX](#)