

# TCN Series

## Highest CV/CC Conductive Polymer Chip Capacitors Undertab

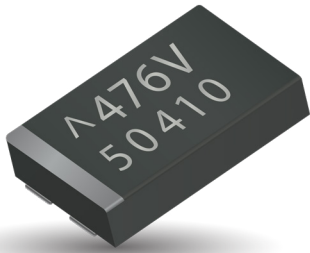

### FEATURES

- Highest CV/cc in Broad Range of Low Profiles
- Conductive Polymer Electrode
- Benign Failure Mode Under Recommended use Conditions
- Lower ESR
- Undertab Terminations Layout:
  - High Volumetric Efficiency
  - High PCB Assembly Density
  - High Capacitance in Smaller Dimensions
- 3x Reflow 260°C Compatible
- 100% Surge Current Tested
- 8 Case Sizes Available

### APPLICATIONS

- Consumer Applications (e.g. Mobiles, MP3 etc.)
- Bulk Decoupling of SoC (System on Chip)

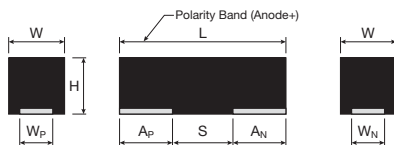

### CASE DIMENSIONS millimeters (inches)

Code	EIA Code	EIA Metric	L±0.20 (0.008)	W±0.20 (0.008) -0.10 (0.004)	H max.	Wp±0.10 (0.004)	Wn±0.10 (0.004)	Ap±0.10 (0.004)	An±0.10 (0.004)	S Min.
S	1206	3216-12	3.20 (0.126)	1.60 (0.063)	1.20 (0.047)	1.30 (0.051)	1.30 (0.051)	1.15 (0.045)	1.15 (0.045)	0.90 (0.035)
L	1210	3528-10	3.50 (0.138)	2.80 (0.110)	1.00 (0.039)	2.50 (0.098)	2.10 (0.083)	1.15 (0.045)	1.35 (0.053)	1.00 (0.039)
T	1210	3528-12	3.50 (0.138)	2.80 (0.110)	1.20 (0.047)	2.50 (0.098)	2.10 (0.083)	1.15 (0.045)	1.35 (0.053)	1.00 (0.039)
H	1210	3528-15	3.50 (0.138)	2.80 (0.110)	1.50 (0.059)	2.50 (0.098)	2.10 (0.083)	1.15 (0.045)	1.35 (0.053)	1.00 (0.039)
X	2917	7343-15	7.30 (0.287)	4.30 (0.169)	1.50 (0.059)	3.25 (0.128)	3.25 (0.128)	2.00 (0.079)	3.20 (0.126)	2.10 (0.083)
Z	2917	7343-15	7.30 ±0.30 (0.287 ±0.012)	4.30 ±0.30 (0.169 ±0.012)	1.50 (0.059)	2.40 (0.094)	2.40 (0.094)	1.30 ±0.30 (0.051 ±0.012)	1.30 ±0.30 (0.051 ±0.012)	4.40 (0.173)
4	2924	7361-20	7.30 (0.287)	6.10 (0.240)	2.00 (0.079)	4.75 (0.187)	4.75 (0.187)	2.00 (0.079)	3.20 (0.126)	2.10 (0.083)
8	2924	7361-20	7.30 ±0.30 (0.287 ±0.012)	6.10 (0.240)	2.00 (0.079)	4.45 (0.175)	4.45 (0.175)	1.60 ±0.30 (0.063 ±0.012)	1.60 ±0.30 (0.063 ±0.012)	3.80 (0.150)

### MARKING

#### H, L, S, T, X, Z CASE

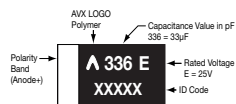

#### 4, 8 CASE

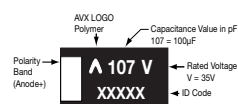

### HOW TO ORDER

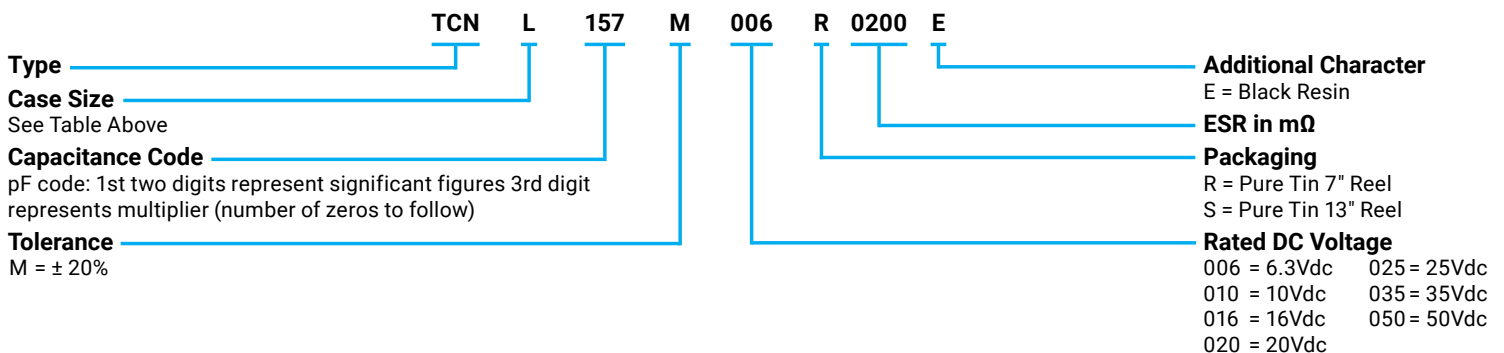

# TCN Series

## Highest CV/CC Conductive Polymer Chip Capacitors Undertab



### TECHNICAL SPECIFICATIONS

Technical Data:	All technical data relate to an ambient temperature of +25°C								
Capacitance Range:	4.7 μF to 1500 μF								
Capacitance Tolerance:	±20%								
Leakage Current DCL:	0.1CV								
Rated Voltage DC (V <sub>R</sub> )	≤ +85°C:	6.3	10	16	20	25	35	50	
Category Voltage (V <sub>C</sub> )	≤ +105°C:	5	8	13	16	20	28	40	
Surge Voltage (V <sub>S</sub> )	≤ +85°C:	8	13	21	26	33	46	65	
Surge Voltage (V <sub>S</sub> )	≤ +105°C:	6	10	16	20	25	35	50	
Temperature Range:	-55°C to +105°C								

NOTE: Conductive Polymer Capacitors are designed to operate within the limits of the environmental conditions specified for each series. If operated continuously at their maximum temperature and / or humidity limit, or beyond these limits, capacitors may exhibit a parametric shift in capacitance and increases in ESR. These changes may occur earlier if the specified environmental conditions are exceeded. Similarly, their normal operational time period will be significantly extended if their general duty cycle includes operation below maximum temperature within humidity controlled environments. Careful attention should be paid to maximum temperature with associated high humidity environments as well as voltage derating, ripple current and current surges. Please reference the AVX Conductive Polymer Capacitor Guidelines for more information or contact factory for application assistance.

### CAPACITANCE AND RATED VOLTAGE RANGE (LETTER DENOTES CASE SIZE)

Capacitance		Rated Voltage DC to 85°C / 0.66DC to 105°C						
μF	Code	6.3V (J)	10V (A)	16V (C)	20V (D)	25V (E)	35V (V)	50V (T)
4.7	475						L(300)/T(200)	
10	106						T(150, 200)	
22	226					T(200)		
33	336			L(200)/T(200)				4(200)
47	476			L(250)/T(150)		X(100)	X(150)/Z(150)	
100	107	L(200)/S(250)				4(100)	4(100)/8(100)	
150	157	L(200)/T(200)		X(100)		4(70)/8(70)		
220	227	H(170)		4(70)	4(100)	4(100)		
330	337			4(70)	4(100)			
470	477	X(50)		4(70,100)				
680	687		4(70)					
1000	108	4(55)						
1500	158	4(55)						

Released ratings, (ESR ratings in mOhms in parentheses)

Engineering Samples - Please Contact AVX

Note: Voltage ratings are minimum values. AVX reserves the right to supply higher voltage ratings in the same case size, to the same reliability standards.

# TCN Series

## Highest CV/CC Conductive Polymer Chip Capacitors Undertab



### RATINGS & PART NUMBER REFERENCE

AVX Part No.	Case Size	Capacitance (µF)	Rated Voltage (V)	Maximum Operating Temperature (°C)	DCL Max. (µA)	DF Max. (%)	ESR Max. @ 100kHz (mΩ)	100kHz RMS Current (mA)			Product Category	MSL
								45°C	85°C	105°C		
<b>6.3 Volt @ 85°C</b>												
TCNL107M006#0200E	L	100	6.3	105	60	10	200	700	500	300	3	5
TCNS107M006#0250E	S	100	6.3	105	60	10	250	600	400	300	3	3
TCNL157M006#0200E	L	150	6.3	105	90	10	200	700	500	300	3	5
TCNT157M006#0200E	T	150	6.3	105	90	10	200	700	500	300	3	4
TCNH227M006#0170E	H	220	6.3	105	132	10	170	800	600	400	3	4
TCNX477M006#0050E	X	470	6.3	85	282	10	50	1900	1300	-	5	5
TCN4108M006#0055E	4	1000	6.3	85	600	20	55	1860	1302	-	5	4
TCN4158M006#0055E	4	1500	6.3	85	900	20	55	1860	1302	-	5	4
<b>10 Volt @ 85°C</b>												
TCN4687M010#0070E	4	680	10	105	680	20	70	1650	1155	660	3	4
<b>16 Volt @ 85°C</b>												
TCNL336M016#0200E	L	33	16	85	52.8	6	200	700	500	-	5	5
TCNT336M016#0200E	T	33	16	105	52.8	6	200	700	500	300	3	4
TCNL476M016#0250E	L	47	16	85	75.2	6	250	600	400	-	5	5
TCNT476M016#0150E	T	47	16	105	75.2	6	150	800	600	400	3	4
TCNX157M016#0100E	X	150	16	105	240	6	100	1300	900	600	3	4
TCN4227M016#0070E	4	220	16	105	352	20	70	1650	1155	660	2	4
TCN4337M016#0070E	4	330	16	105	528	20	70	1650	1155	660	3	4
TCN4477M016#0070E	4	470	16	105	752	20	70	1650	1155	660	3	4
TCN4477M016#0100E	4	470	16	105	752	20	100	1380	966	552	3	4
<b>20 Volt @ 85°C</b>												
TCN4227M020#0100E	4	220	20	85	440	10	100	1380	966	-	5	4
TCN4337M020#0100E	4	330	20	105	660	20	100	1380	966	552	3	4
<b>25 Volt @ 85°C</b>												
TCNT226M025#0200E	T	22	25	105	55	6	200	700	500	300	3	4
TCNX476M025#0100E	X	47	25	105	117.5	6	100	1300	900	600	2	5
TCN4107M025#0100E	4	100	25	105	250	6	100	1380	966	552	2	4
TCN4157M025#0070E	4	150	25	105	375	6	70	1650	1155	660	2	4
TCN8157M025#0070E	8	150	25	105	375	8	70	1650	1155	660	2	3
TCN4227M025#0100E	4	220	25	105	550	10	100	1380	966	552	3	4
<b>35 Volt @ 85°C</b>												
TCNL475M035#0300E	L	4.7	35	105	16.5	6	300	600	400	300	2	5
TCNT475M035#0200E	T	4.7	35	105	16.5	10	200	700	500	300	3	4
TCNT106M035#0150E	T	10	35	105	35	10	150	800	600	400	3	4
TCNT106M035#0200E	T	10	35	105	35	10	200	700	500	300	3	4
TCNX476M035#0150E	X	47	35	105	165	10	150	1100	800	500	3	4
TCNZ476M035#0150E	Z	47	35	105	165	10	150	1100	800	500	3	4
TCN4107M035#0100E	4	100	35	105	350	10	100	1380	966	552	2	3
TCN8107M035#0100E	8	100	35	105	350	10	100	1380	966	552	2	3
<b>50 Volt @ 85°C</b>												
TCN4336M050#0200E	4	33	50	85	165	12	200	970	679	-	5	3

Moisture Sensitivity Level (MSL) is defined according to J-STD-020.

All technical data relates to an ambient temperature of +25°C. Capacitance and DF are measured at 120Hz, 0.5RMS with DC bias of 2.2 volts. DCL is measured at rated voltage after 5 minutes.

ESR allowed to move up to 1.25 times catalog limit post mounting.

For typical weight and composition see page 276.

**NOTE: AVX reserves the right to supply higher voltage ratings in the same case size to the same reliability standards.**

### RECOMMENDED DERATING FACTOR

Voltage and temperature derating as percentage of Vr

Product Category 2

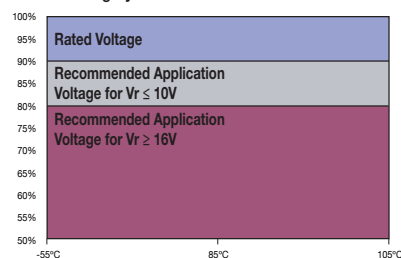

Product Category 3

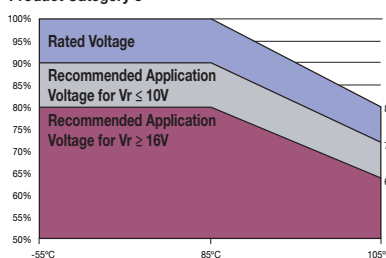

Product Category 5

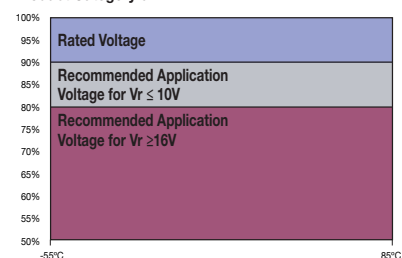

### PRODUCT CATEGORY 2, 3 (TEMPERATURE RANGE -55°C TO +105°C)

TEST	Condition			Characteristics						
<b>Endurance</b>	Apply rated voltage (Ur) at 85°C for 2000 hours through a circuit impedance of $\leq 0.1\Omega/V$ (all CATEGORIES). And / or apply rated voltage (Ur) (CATEGORY 2) or 0.8x rated voltage (CATEGORY 3) at 105°C for 2000 hours through a circuit impedance of $\leq 0.1\Omega/V$ . Always stabilize at room temperature for 1-2 hours before measuring.			Visual examination	no visible damage					
				DCL	1.25 x initial limit					
				$\Delta C/C$	within $\pm 20\%$ of initial value					
				DF	1.5 x initial limit					
				ESR	2 x initial limit					
<b>Storage Life</b>	Store at 105°C, no voltage applied, for 2000 hours. Stabilize at room temperature for 1-2 hours before measuring.			Visual examination	no visible damage					
				DCL ( $V_R \leq 75V$ )	1.25 x initial limit					
				DCL ( $V_R > 75V$ )	2 x initial limit					
				$\Delta C/C$	within $\pm 20\%$ of initial value					
				DF	1.5 x initial limit					
<b>Humidity</b>	Store at 65°C and 95% relative humidity for 500 hours, with no applied voltage. Stabilize at room temperature and humidity for 1-2 hours before measuring.			Visual examination	no visible damage					
				DCL	3 x initial limit					
				$\Delta C/C$	within +30/-20% of initial value					
				DF	1.5 x initial limit					
				ESR	2 x initial limit					
<b>Temperature Stability</b>	Step	Temperature°C	Duration(min)							
	1	+20	15							
	2	-55	15							
	3	+20	15	DCL	IL*	n/a	IL*	10 x IL*	12.5 x IL*	IL*
	4	+85	15	$\Delta C/C$	n/a	+0/-20%	$\pm 5\%$	+20/-0%	+30/-0%	$\pm 5\%$
	5	+105	15	DF	IL*	1.5 x IL*	IL*	1.5 x IL*	2 x IL*	IL*
	6	+20	15							
<b>Surge Voltage</b>	Apply 1.3x rated voltage (Ur) at 105°C for CATEGORY 2, or apply 1.3x 0.8x rated voltage (Ur) at 105°C for CATEGORY 3 for 1000 cycles of duration 6 min (30 sec charge, 5 min 30 sec discharge) through a charge / discharge resistance of 1000 $\Omega$			Visual examination	no visible damage					
				DCL	initial limit					
				$\Delta C/C$	within +10/-20% of initial value for $V_R \leq 10V$ within +20/-30% of initial value for $V_R \geq 16V$					
				DF	1.25 x initial limit					
<b>Mechanical Shock</b>	MIL-STD-202, Method 213, Condition C			Visual examination	no visible damage					
				DCL	initial limit					
				$\Delta C/C$	within $\pm 5\%$ of initial value					
				DF	initial limit					
				ESR	initial limit					
<b>Vibration</b>	MIL-STD-202, Method 204, Condition D			Visual examination	no visible damage					
				DCL	initial limit					
				$\Delta C/C$	within $\pm 5\%$ of initial value					
				DF	initial limit					
				ESR	initial limit					

\*Initial Limit

Initial measurement max. 1hr after the removal from dry pack or after pretreatment at 85°C for 24 hours.

# TCN Series

## Highest CV/CC Conductive Polymer Chip Capacitors Undertab



### PRODUCT CATEGORY 5 (TEMPERATURE RANGE -55°C TO +85°C)

TEST	Condition			Characteristics								
<b>Endurance</b>	Apply rated voltage (Ur) at 85°C for 2000 hours through a circuit impedance of $\leq 0.1\Omega/V$ . Stabilize at room temperature for 1-2 hours before measuring.			Visual examination	no visible damage							
				DCL	1.25 x initial limit							
				$\Delta C/C$	within $\pm 20\%$ of initial value							
				DF	1.5 x initial limit							
				ESR	2 x initial limit							
<b>Storage Life</b>	Store at 85°C, no voltage applied, for 2000 hours. Stabilize at room temperature for 1-2 hours before measuring.			Visual examination	no visible damage							
				DCL	1.25 x initial limit							
				$\Delta C/C$	within $\pm 20\%$ of initial value							
				DF	1.5 x initial limit							
				ESR	2 x initial limit							
<b>Humidity</b>	Store at 65°C and 95% relative humidity for 500 hours, with no applied voltage. Stabilize at room temperature and humidity for 1-2 hours before measuring.			Visual examination	no visible damage							
				DCL	5 x initial limit							
				$\Delta C/C$	within +40/-20% of initial value							
				DF	1.5 x initial limit							
				ESR	2 x initial limit							
<b>Temperature Stability</b>	Step	Temperature°C	Duration(min)									
	1	+20	15									
	2	-55	15	DCL	IL*	n/a	IL*	+20°C	+85°C	+20°C	10 x IL*	IL*
	3	+20	15	$\Delta C/C$	n/a	+0/-20%	$\pm 5\%$	+20/-0%	$\pm 5\%$			
	4	+85	15	DF	IL*	1.5 x IL*	IL*	1.5 x IL*	IL*			
	5	+20	15									
<b>Surge Voltage</b>	Apply 1.3x rated voltage (Ur) at 85°C for 1000 cycles of duration 6 min (30 sec charge, 5 min 30 sec discharge) through a charge / discharge resistance of 1000 $\Omega$ .			Visual examination	no visible damage							
				DCL	initial limit							
				$\Delta C/C$	within +10/-20% of initial value for Vr $\leq 10V$ within +20/-30% of initial value for Vr $\geq 16V$							
				DF	1.25 x initial limit							
<b>Mechanical Shock</b>	MIL-STD-202, Method 213, Condition C			Visual examination	no visible damage							
				DCL	initial limit							
				$\Delta C/C$	within $\pm 5\%$ of initial value							
				DF	initial limit							
				ESR	initial limit							
<b>Vibration</b>	MIL-STD-202, Method 204, Condition D			Visual examination	no visible damage							
				DCL	initial limit							
				$\Delta C/C$	within $\pm 5\%$ of initial value							
				DF	initial limit							
				ESR	initial limit							

\*Initial Limit

Initial measurement max. 1hr after the removal from dry pack or after pretreatment at 85°C for 24 hours.

# TCN Series

## Highest CV/CC Conductive Polymer Chip Capacitors Undertab

### SOLID ELECTROLYTIC CAPACITOR ROADMAP

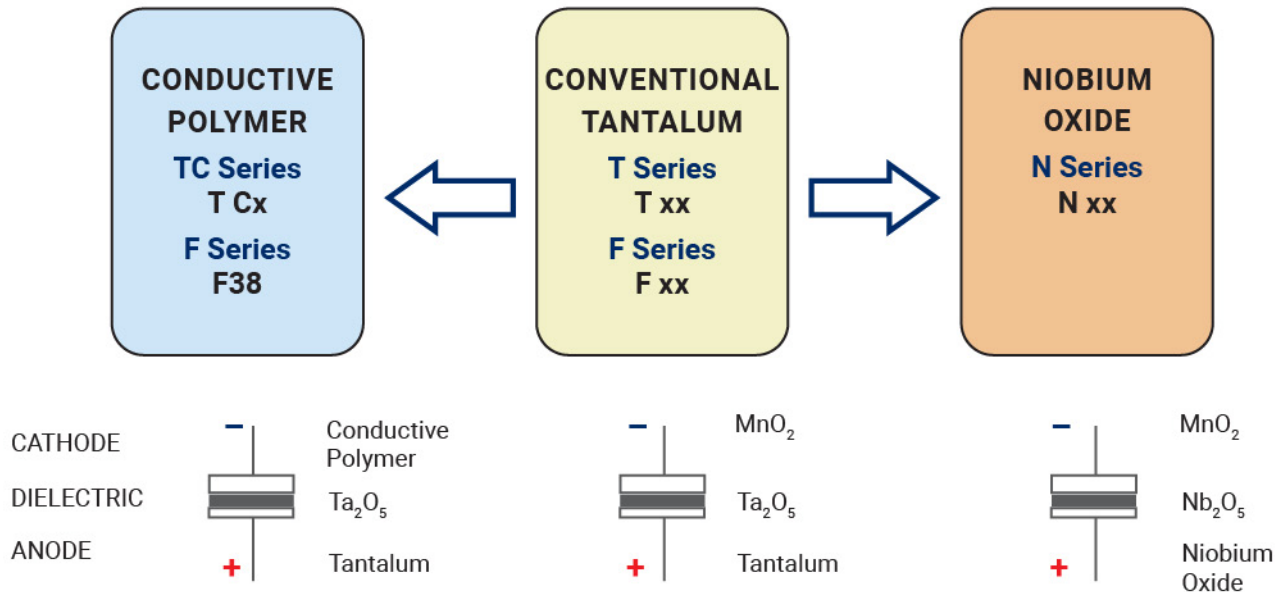

### FIVE CAPACITOR CONSTRUCTION STYLES

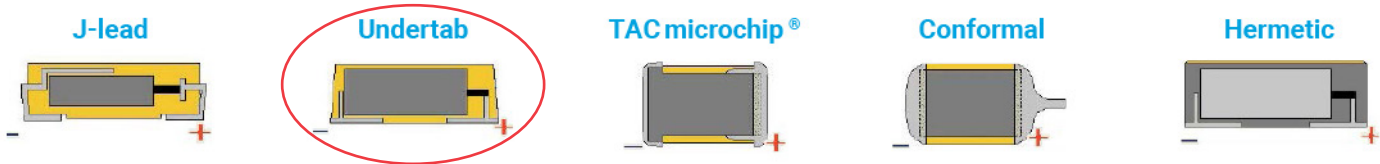

### SERIES LINE UP : Conductive Polymer

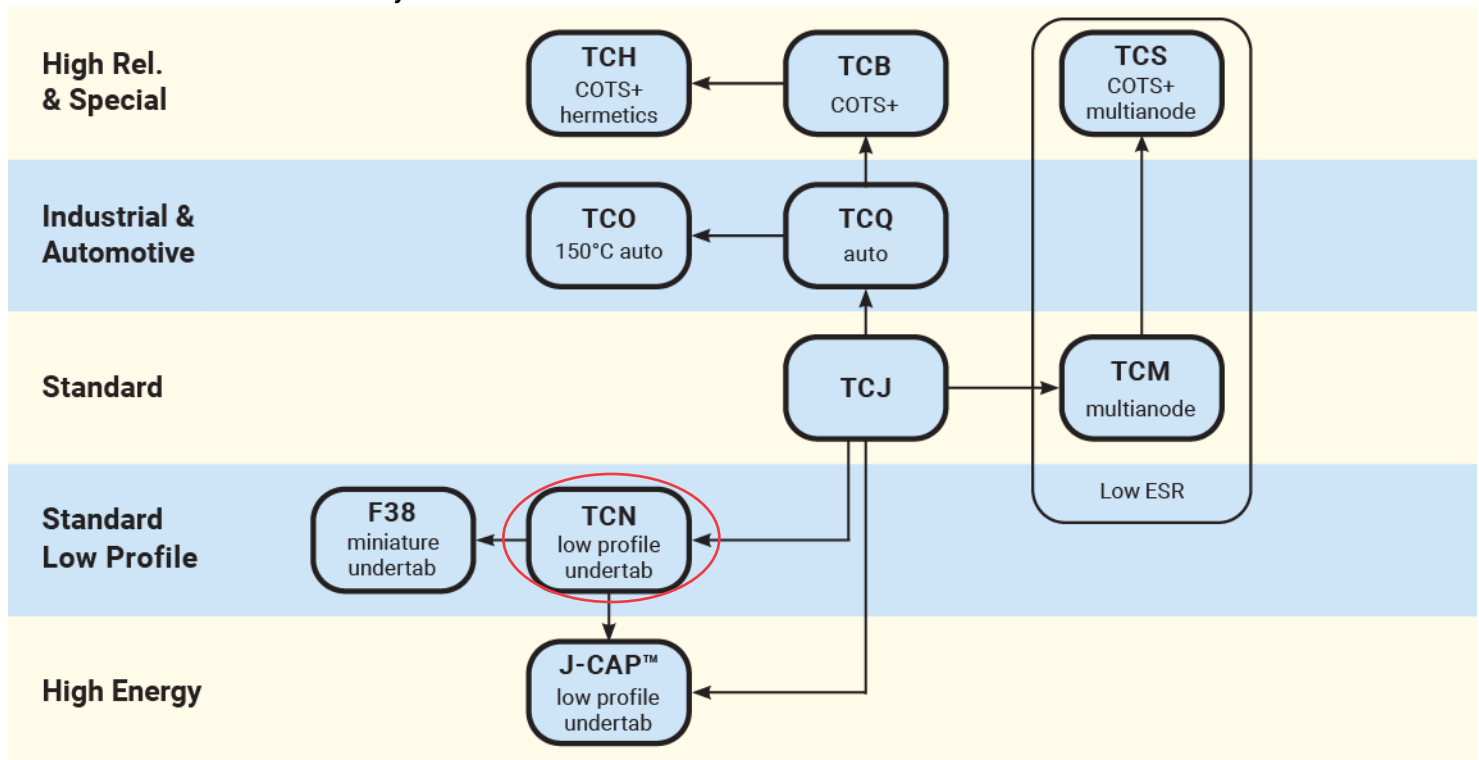

单击下面可查看定价，库存，交付和生命周期等信息

[>>AVX](#)