

TCQ Series

Automotive Conductive Polymer Chip Capacitors

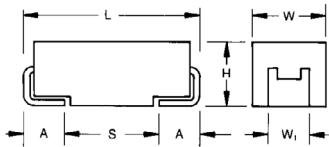

FEATURES

- Conductive Polymer Electrode
- Benign Failure Mode Under Recommended Use Conditions
- Robust Design for Automotive Applications
- Meets Requirements of AEC-Q200
- Humidity 85°C/85%RH, Vr, 1000 hours
- Basic Reliability 1%/1000hrs@85°C Vr with 60% Confidence Level
- -55 to +125°C Operation Temperature
- Full Voltage Range: 2.5-50V
- DCL 0.1 CV
- 3x Reflow 260°C Compatible
- 100% Surge Current Tested



APPLICATIONS

DC/DC converters, Telecommunication (coupling/decoupling), Industrial & special, Automotive (body electronics, cabin controls, infotainment, comfort, after market etc)

Not recommended for use of conductive polymer parts in high power applications. For more information please see AVX automotive application guide at [avx.com](http://www.avx.com) (see the link: <http://www.avx.com/docs/techinfo/ApplicationGuides/Automotive-Application-Guide.pdf>), or contact manufacturer.

AVX's qualification of TCQ capacitors meets requirements of AEC-Q200. TCQ series is manufactured in an IATF 16949 certified facility.

MARKING

B, D, E, U, Y CASE

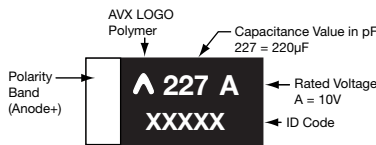

CASE DIMENSIONS:

millimeters (inches)

Code	EIA Code	EIA Metric	L±0.20 (0.008)	W+0.20 (0.008) -0.10 (0.004)	H+0.20 (0.008) -0.10 (0.004)	W _i ±0.20 (0.008)	A+0.30 (0.012) -0.20 (0.008)	S Min.
B	1210	3528-21	3.50 (0.138)	2.80 (0.110)	1.90 (0.075)	2.20 (0.087)	0.80 (0.031)	1.40 (0.055)
D	2917	7343-31	7.30 (0.287)	4.30 (0.169)	2.90 (0.114)	2.40 (0.094)	1.30 (0.051)	4.40 (0.173)
E	2917	7343-43	7.30 (0.287)	4.30 (0.169)	4.10 (0.162)	2.40 (0.094)	1.30 (0.051)	4.40 (0.173)
U	2924	7361-43	7.30 (0.287)	6.10 (0.240)	4.10 (0.162)	3.10 (0.122)	1.30 (0.051)	4.40 (0.173)
Y	2917	7343-20	7.30 (0.287)	4.30 (0.169)	2.00 (0.079) max	2.40 (0.094)	1.30 (0.051)	4.40 (0.173)

W_i dimension applies to the termination width for A dimensional area only.

HOW TO ORDER

TCQ

Type

B

Case Size
See table above

476

Capacitance Code
pF code: 1st two digits represent significant figures, 3rd digit represents multiplier (number of zeros to follow)

M

Tolerance
M = ±20%

006

Rated DC Voltage
002 = 2.5Vdc
004 = 4Vdc
006 = 6.3Vdc
010 = 10Vdc
016 = 16Vdc
020 = 20Vdc
025 = 25Vdc
035 = 35Vdc
050 = 50Vdc

#

Packaging
R = Pure Tin 7" Reel
S = Pure Tin 13" Reel

0070

ESR in mΩ

E

Additional Character
E = Black resin

TECHNICAL SPECIFICATIONS

Technical Data:	All technical data relate to an ambient temperature of +25°C
Capacitance Range:	10 µF to 470 µF
Capacitance Tolerance:	±20%
Leakage Current DCL:	0.1CV
Temperature Range:	-55°C to +125°C
	Meets requirements of AEC-Q200

NOTE: Conductive Polymer Capacitors are designed to operate within the limits of the environmental conditions specified for each series. If operated continuously at their maximum temperature and / or humidity limit, or beyond these limits, capacitors may exhibit a parametric shift in capacitance and increases in ESR. These changes may occur earlier if the specified environmental conditions are exceeded. Similarly, their normal operational time period will be significantly extended if their general duty cycle includes operation below maximum temperature within humidity controlled environments. Careful attention should be paid to maximum temperature with associated high humidity environments as well as voltage derating, ripple current and current surges. Please reference the AVX Conductive Polymer Capacitor Guidelines for more information or contact factory for application assistance.

TCQ Series

Automotive Conductive Polymer Chip Capacitors



CAPACITANCE AND RATED VOLTAGE RANGE (LETTER DENOTES CASE SIZE)

Capacitance		Rated Voltage DC (V _R) @ 105°C								
µF	Code	2.5 (e)	4V (G)	6.3V (J)	10V (A)	16V (C)	20V (D)	25V (E)	35V (V)	50V (T)
10	106						B(150)		D(70)	D(90)
15	156					B(90)	B(150)	D(70)	D(125)	
22	226			B(70)	B(70)	B(70)	D(70)	D(100)	D(100)	
33	336			B(70)	B(70)	D(70),Y(70)	D(70)	D(100)	E(65), U(70)	
47	476			B(70)	B(70)	D(70),Y(70)	D(70),Y(70)	E(50)	E(75), U(70)	
68	686			B(70)	D(25,40)	D(70)		E(60)		
100	107	B(70)	B(70)		D(25,40)		E(40)	U(70)		
150	157			D(25,40)	D(25)	E(40)				
220	227		D(25),Y(25)	D(25)	D(25)					
330	337		D(25)	D(25)						
470	477		D(25)							

Released ratings, (ESR ratings in mOhms in parentheses)

Note: Voltage ratings are minimum values. AVX reserves the right to supply higher voltage ratings in the same case size, to the same reliability standards.

RATINGS & PART NUMBER REFERENCE

AVX Part No.	Case Size	Capacitance (µF)	Rated Voltage (V)	Maximum Operating Temp. (°C)	DCL Max (µA)	DF Max (%)	ESR Max @ 100kHz (mΩ)	100kHz RMS Current (mA)				Humidity 85°C/85% RH, Vr (hrs)	MSL
								45°C	85°C	105°C	125°C		
2.5 Volt													
TCQB107M002#0070E	B	100	2.5	125	25	6	70	1336	935	601	334	1000	3
4 Volt													
TCQB107M004#0070E	B	100	4	125	40	8	70	1336	935	601	334	1000	3
TCQD227M004#0025E	D	220	4	125	88	6	25	3000	2100	1350	750	1000	3
TCQY227M004#0025E	Y	220	4	125	88	6	25	2720	1904	1224	680	1000	3
TCQD337M004#0025E	D	330	4	125	132	6	25	3000	2100	1350	750	1000	3
TCQD477M004#0025E	D	470	4	125	188	6	25	3000	2100	1350	750	1000	3
6.3 Volt													
TCQB226M006#0070E	B	22	6.3	125	13.2	6	70	1336	935	601	334	1000	3
TCQB336M006#0070E	B	33	6.3	125	19.8	6	70	1336	935	601	334	1000	3
TCQB476M006#0070E	B	47	6.3	125	28.2	6	70	1336	935	601	334	1000	3
TCQB686M006#0070E	B	68	6.3	125	40.8	8	70	1336	935	601	334	1000	3
TCQD157M006#0025E	D	150	6.3	125	90	6	25	3000	2100	1350	750	1000	3
TCQD157M006#0040E	D	150	6.3	125	90	6	40	2372	1660	1067	593	1000	3
TCQD227M006#0025E	D	220	6.3	125	132	6	25	3000	2100	1350	750	1000	3
TCQD337M006#0025E	D	330	6.3	125	198	6	25	3000	2100	1350	750	1000	3
10 Volt													
TCQB226M010#0070E	B	22	10	125	22	6	70	1336	935	601	334	1000	3
TCQB336M010#0070E	B	33	10	125	33	6	70	1336	935	601	334	1000	3
TCQB476M010#0070E	B	47	10	125	47	6	70	1336	935	601	334	1000	3
TCQD686M010#0025E	D	68	10	125	68	6	25	3000	2100	1350	750	1000	3
TCQD686M010#0040E	D	68	10	125	68	6	40	2372	1660	1067	593	1000	3
TCQD107M010#0025E	D	100	10	125	100	6	25	3000	2100	1350	750	1000	3
TCQD107M010#0040E	D	100	10	125	100	6	40	2372	1660	1067	593	1000	3
TCQD157M010#0025E	D	150	10	125	150	6	25	3000	2100	1350	750	1000	3
TCQD227M010#0025E	D	220	10	125	220	6	25	3000	2100	1350	750	1000	3
16 Volt													
TCQB156M016#0090E	B	15	16	125	24	8	90	1179	825	530	295	1000	3
TCQB226M016#0070E	B	22	16	125	35.2	8	70	1336	935	601	334	1000	3
TCQD336M016#0070E	D	33	16	125	52.8	6	70	1793	1255	807	448	1000	3
TCQY336M016#0070E	Y	33	16	125	52.8	6	70	1626	1138	732	406	1000	3
TCQD476M016#0070E	D	47	16	125	75.2	6	70	1793	1255	807	448	1000	3
TCQY476M016#0070E	Y	47	16	125	75.2	6	70	1626	1138	732	406	1000	3
TCQD686M016#0070E	D	68	16	125	109	8	70	1793	1255	807	448	1000	3
TCQE157M016#0040E	E	150	16	125	240	10	40	2500	1750	1125	625	1000	3
20 Volt													
TCQB106M020#0150E	B	10	20	125	20	8	150	913	639	411	228	1000	3
TCQB156M020#0150E	B	15	20	125	30	8	150	913	639	411	228	1000	3
TCQD226M020#0070E	D	22	20	125	44	6	70	1793	1255	807	448	1000	3
TCQD336M020#0070E	D	33	20	125	66	8	70	1793	1255	807	448	1000	3
TCQD476M020#0070E	D	47	20	125	94	6	70	1793	1255	807	448	1000	3
TCQY476M020#0070E	Y	47	20	125	94	6	70	1626	1138	732	406	1000	3
TCQE107M020#0040E	E	100	20	125	200	10	40	2500	1750	1125	625	1000	3

TCQ Series

Automotive Conductive Polymer Chip Capacitors



RATINGS & PART NUMBER REFERENCE

AVX Part No.	Case Size	Capacitance (μF)	Rated Voltage (V)	Maximum Operating Temp. (°C)	DCL Max (μA)	DF Max (%)	ESR Max @ 100kHz (mΩ)	100kHz RMS Current (mA)				Humidity 85°C/85% RH, Vr (hrs)	MSL
								45°C	85°C	105°C	125°C		
25 Volt													
TCQD156M025#0070E	D	15	25	125	37.5	6	70	1793	1255	807	448	1000	3
TCQD226M025#0100E	D	22	25	125	55	8	100	1500	1050	675	375	1000	3
TCQD336M025#0100E	D	33	25	125	82.5	8	100	1500	1050	675	375	1000	3
TCQE476M025R0050E	E	47	25	125	117.5	10	50	2236	1565	1006	559	1000	3
TCQE686M025R0060E	E	68	25	125	170	10	60	2041	1429	919	510	1000	3
TCQU107M025R0070E	U	100	25	125	250	12	70	2330	1631	1048	582	1000	3
35 Volt													
TCQD106M035#0070E	D	10	35	125	35	6	70	1793	1255	807	448	1000	3
TCQD156M035#0125E	D	15	35	125	52.5	8	125	1342	939	604	335	1000	3
TCQD226M035#0100E	D	22	35	125	77	8	100	1500	1050	675	375	1000	3
TCQU336M035R0070E	U	33	35	125	115.5	12	70	2330	1631	1048	582	1000	3
TCQE336M035R0065E	E	33	35	125	115.5	10	65	1961	1373	883	490	1000	3
TCQE476M035R0075E	E	47	35	125	164.5	10	75	1826	1278	822	456	1000	3
TCQU476M035R0070E	U	47	35	125	164.5	12	70	2330	1631	1048	582	1000	3
50 Volt													
TCQD106M050#0090E	D	10	50	125	50	10	90	1581	1107	712	395	1000	3

Moisture Sensitivity Level (MSL) is defined according to J-STD-020. All technical data relates to an ambient temperature of +25°C. Capacitance and DF are measured at 120Hz, 0.5RMS with DC bias of 2.2 volts. DCL is measured at rated voltage after 5 minutes.

ESR allowed to move up to 1.25 times catalog limit post mounting. For typical weight and composition see page 276.

NOTE: AVX reserves the right to supply higher voltage ratings or tighter tolerance part in the same case size, to the same reliability standards.

RECOMMENDED DERATING FACTOR

Voltage and temperature derating as percentage of Vr

Rated voltage	Operating Temperature		
	≤85°C	105°C	125°C
≤10V	90%	90%	60%
≥16V	80%	80%	54%

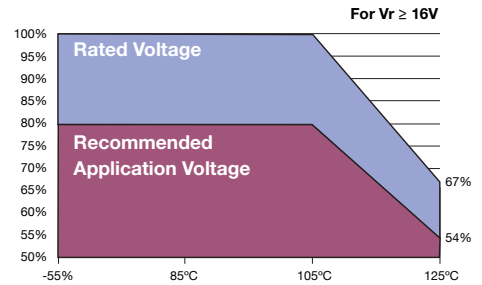
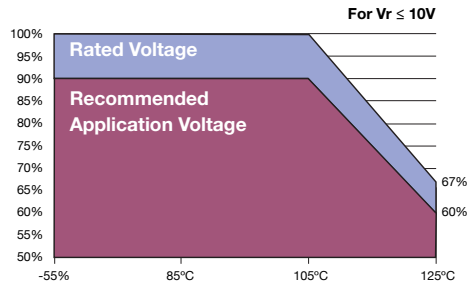

TCQ Series

Automotive Conductive Polymer Chip Capacitors

QUALIFICATION TABLE

TEST	TCQ series (Temperature range -55°C to 125°C)									
	Condition			Characteristics						
Endurance	Apply 2/3 rated voltage (Ur) at 125°C for 2000 hours through a circuit impedance of $\leq 0.1\Omega/V$. Stabilize at room temperature for 1-2 hours before measuring.			Visual examination	no visible damage					
				DCL	2 x initial limit					
				$\Delta C/C$	within +10/-20% of initial value					
				DF	2 x initial limit					
				ESR	2 x initial limit					
Storage Life	Store at 125°C, no voltage applied, for 2000 hours. Stabilize at room temperature for 1-2 hours before measuring.			Visual examination	no visible damage					
				DCL	2x initial limit					
				$\Delta C/C$	within +10/-20% of initial value					
				DF	2 x initial limit					
				ESR	2 x initial limit					
Biased Humidity	Apply rated voltage (Ur) at 85°C, 85% relative humidity for 1000 hours. Stabilize at room temperature and humidity for 1-2 hours before measuring.			Visual examination	no visible damage					
				DCL	2 x initial limit					
				$\Delta C/C$	within +35/-5% of initial value					
				DF	1.5 x initial limit					
				ESR	2 x initial limit					
Temperature Stability	Step	Temperature°C	Duration(min)		+20°C	-55°C	+20°C	+85°C	+125°C	+20°C
	1	+20	15							
	2	-55	15	DCL	IL*	n/a	IL*	10 x IL*	12.5 x IL*	IL*
	3	+20	15							
	4	+85	15	$\Delta C/C$	n/a	$\pm 20\%$	$\pm 5\%$	$\pm 20\%$	$\pm 30\%$	$\pm 5\%$
	5	+125	15	DF	IL*	IL*	IL*	1.2 x IL*	1.5 x IL*	IL*
6	+20	15								
Surge Voltage	Apply 1.3x 2/3x rated voltage (Ur) at 125°C for 1000 cycles of duration 6 min (30 sec charge, 5 min 30 sec discharge) through a charge / discharge resistance of 1000 Ω			Visual examination	no visible damage					
				DCL	initial limit					
				$\Delta C/C$	within +10/-20% of initial value for Vr \leq 10V within +20/-30% of initial value for Vr \geq 16V					
				DF	initial limit for Vr \leq 10V 1.25x initial limit for Vr \geq 16V					
				ESR	1.25 x initial limit					
Mechanical Shock	MIL-STD-202, Method 213, Condition F			Visual examination	no visible damage					
				DCL	initial limit					
				$\Delta C/C$	within $\pm 10\%$ of initial value					
				DF	initial limit					
				ESR	1.25 x initial limit					
Vibration	MIL-STD-202, Method 204, Condition D			Visual examination	no visible damage					
				DCL	initial limit					
				$\Delta C/C$	within $\pm 10\%$ of initial value					
				DF	initial limit					
				ESR	1.25 x initial limit					

*Initial Limit

For use outside of recommended conditions and special request, please contact AVX.

Initial measurement max. 1hr after the removal from dry pack or after pretreatment at 85°C for 24 hours.

SOLID ELECTROLYTIC CAPACITOR ROADMAP

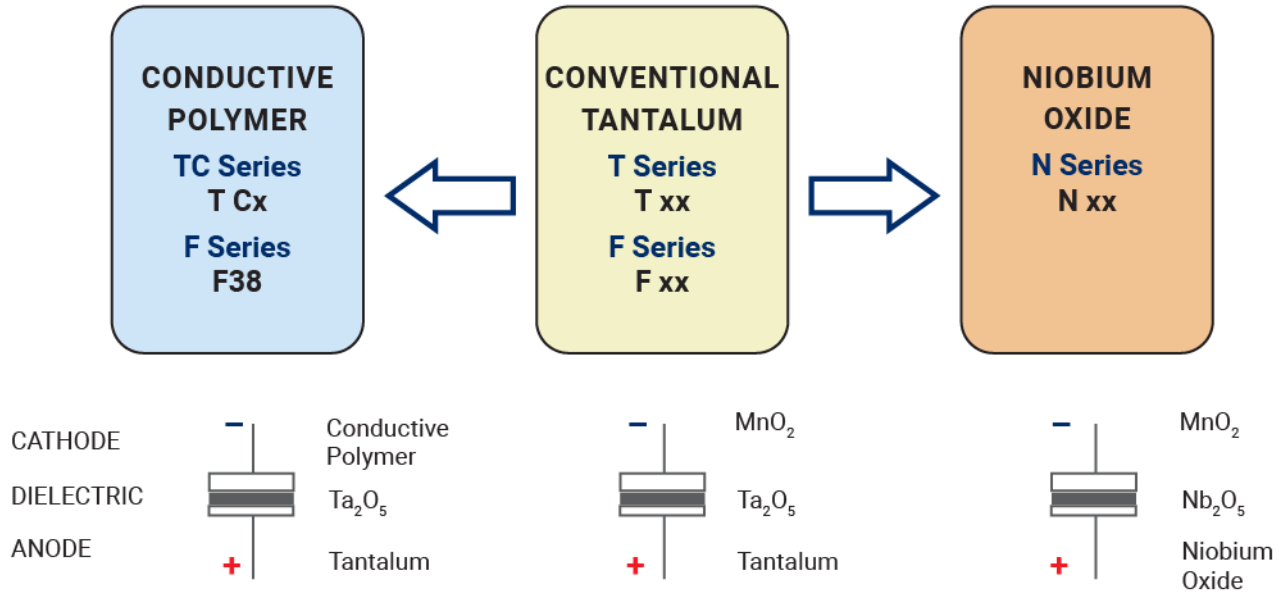

FIVE CAPACITOR CONSTRUCTION STYLES

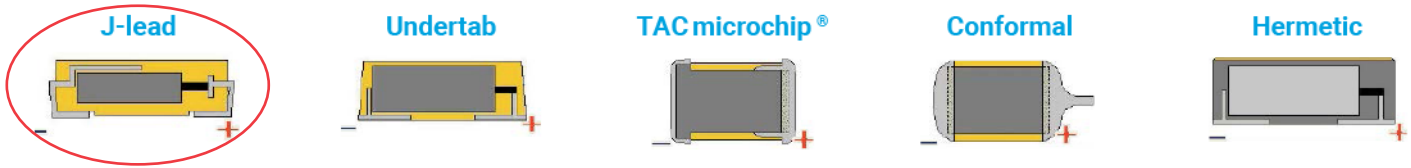

SERIES LINE UP : Conductive Polymer

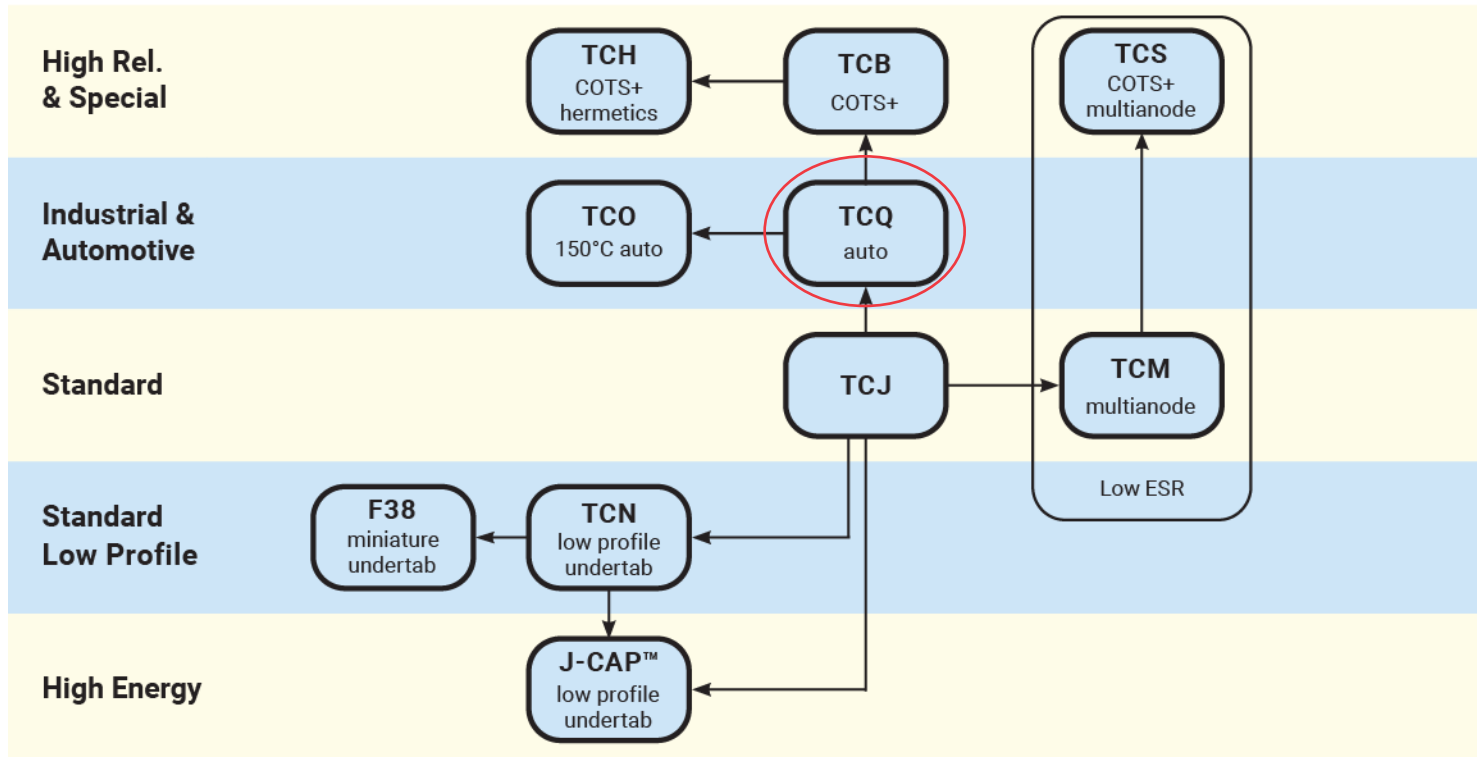

单击下面可查看定价，库存，交付和生命周期等信息

[>>AVX](#)