

TPM Multianode

Tantalum Ultra Low ESR Capacitor

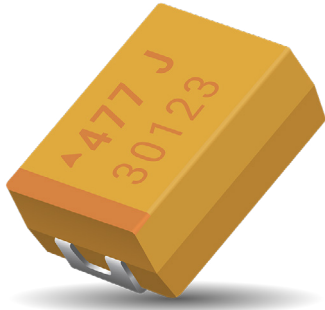

FEATURES

- Multi-anode Construction
- Super Low ESR
- 100% Surge Current Tested
- CV Range: 10-2200 μ F / 2.5-50V
- 5 Case Sizes Available
- "Mirror" Multi-anode Construction Used with D, Y Case Capacitors Reduces ESL to Half



SnPb termination option is not RoHS compliant.

APPLICATIONS

- High Power DC/DC General Applications

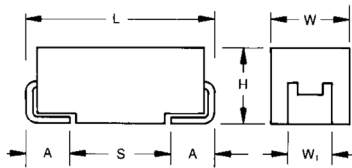

MULTIANODE CONSTRUCTION



MULTIANODE TPM D, Y LOW SELF INDUCTANCE CONSTRUCTION "MIRROR" DESIGN

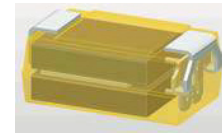

MARKING

D, E, U, V, Y CASE

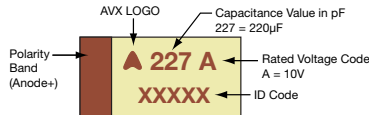

CASE DIMENSIONS:

millimeters (inches)

Code	EIA Code	EIA Metric	L \pm 0.20 (0.008)	W \pm 0.20 (0.008) -0.10 (0.004)	H \pm 0.20 (0.008) -0.10 (0.004)	W \pm 0.20 (0.008)	A \pm 0.30 (0.012) -0.20 (0.008)	S Min.
D	2917	7343-31	7.30 (0.287)	4.30 (0.169)	2.90 (0.114)	2.40 (0.094)	1.30 (0.051)	4.40 (0.173)
E	2917	7343-43	7.30 (0.287)	4.30 (0.169)	4.10 (0.162)	2.40 (0.094)	1.30 (0.051)	4.40 (0.173)
U	2924	7361-43	7.30 (0.287)	6.10 (0.240)	4.10 (0.162)	3.10 (0.122)	1.30 (0.051)	4.40 (0.173)
V	2924	7361-38	7.30 (0.287)	6.10 (0.240)	3.55 (0.140)	3.10 (0.122)	1.30 (0.051)	4.40 (0.173)
Y	2917	7343-20	7.30 (0.287)	4.30 (0.169)	2.00 (0.079) max	2.40 (0.094)	1.30 (0.051)	4.40 (0.173)

W1 dimension applies to the termination width for A dimensional area only.

HOW TO ORDER

TPM

Type

E

Case Size
See table above

108

Capacitance Code
pF code: 1st two digits represent significant figures, 3rd digit represents multiplier (number of zeros to follow)

M

Tolerance
K = \pm 10%
M = \pm 20%

004

Rated DC Voltage
002=2.5Vdc
004=4Vdc
006=6.3Vdc
010=10Vdc
016=16Vdc
020=20Vdc
025=25Vdc
035=35Vdc
050=50Vdc

R

Packaging
R = Pure Tin 7" Reel
S = Pure Tin 13" Reel
H = Tin Lead 7" Reel
(Contact Manufacturer)
K = Tin Lead 13" Reel
(Contact Manufacturer)
H, K = Non RoHS

0018

ESR in m Ω

TECHNICAL SPECIFICATIONS

Technical Data:		All technical data relate to an ambient temperature of +25°C									
Capacitance Range:		10 μ F to 2200 μ F									
Capacitance Tolerance:		\pm 10%, \pm 20%									
Rated Voltage (V_R)	\leq +85°C:	2.5	4	6.3	10	16	20	25	35	50	
Category Voltage (V_C)	\leq +125°C:	1.7	2.7	4	7	10	13	17	23	33	
Surge Voltage (V_S)	\leq +85°C:	3.3	5.2	8	13	20	26	32	46	65	
Surge Voltage (V_S)	\leq +125°C:	2.2	3.4	5	8	13	16	20	28	40	
Temperature Range:		-55°C to +125°C									
Reliability:		1% per 1000 hours at 85°C, V_R with 0.1 Ω /V series impedance, 60% confidence level									

TPM Multianode

Tantalum Ultra Low ESR Capacitor



CAPACITANCE AND RATED VOLTAGE RANGE (LETTER DENOTES CASE SIZE)

Capacitance		Rated Voltage DC (V _R) to 85°C								
µF	Code	2.5V (e)	4V (G)	6.3V (J)	10V (A)	16V (C)	20V (D)	25V (E)	35V (V)	50V (T)
6.8	685									
10	106									D(140)/E(120)
15	156									E(75,100)
22	226								D(70) E(60,100)	E(75,100)
33	336							D(65)	E(50,65)	
47	476					D(100)	D(45,55)	D(55)/E(65)	E(55,65)	
68	686					D(40,50)		E(45,55)		
100	107				Y(45) ^(M)	D(40,50)	E(35,45)	E(45,60)		
150	157				Y(45) ^(M)	E(30,40)	E(35)			
220	227			Y(30) ^(M)	D(35)	E(25,40) U(30,40)				
330	337		D(25,35)	D(25,35)	D(35)/E(23,35)	E(50)				
470	477		D(25,35)	D(30) E(18,23,30)	E(23,30) U(23,30)					
680	687		D(25)/E(18,23)	E(18,23) U(18,23)/V(23)						
1000	108	D(25)	D(25,45) E(18,23) U(18,23)/V(18)	E(25) ^(M) /V(20) ^(M)						
1500	158	E(12,15,18) U(18,23)	E(15,18)							
2200	228	E(18) ^(M)								

Released ratings ^(M tolerance only), (ESR ratings in mOhms in parentheses)

Note: Voltage ratings are minimum values. AVX reserves the right to supply higher voltage ratings in the same case size, to the same reliability standards.

TPM Multianode

Tantalum Ultra Low ESR Capacitor



RATINGS & PART NUMBER REFERENCE

AVX Part No.	Case Size	Capacitance (µF)	Rated Voltage (V)	Rated Temperature (°C)	Category Voltage (V)	Category Temperature (°C)	DCL Max. (µA)	DF Max. (%)	ESR Max. @ 100kHz (mΩ)	100kHz RMS Current (A)			MSL
										25°C	85°C	125°C	
2.5 Volt @ 85°C													
TPMD108*002#0025	D	1000	2.5	85	1.7	125	25	8	25	3.194	2.874	1.277	3
TPME158*002#0012	E	1500	2.5	85	1.7	125	38	6	12	4.743	4.269	1.897	3
TPME158*002#0015	E	1500	2.5	85	1.7	125	38	6	15	4.243	3.818	1.697	3
TPME158*002#0018	E	1500	2.5	85	1.7	125	38	6	18	3.873	3.486	1.549	3
TPMU158*002R0018	U	1500	2.5	85	1.7	125	30	6	18	4.048	3.643	1.619	3
TPMU158*002R0023	U	1500	2.5	85	1.7	125	30	6	23	3.581	3.223	1.433	3
TPME228M002#0018	E	2200	2.5	85	1.7	125	44	10	18	3.873	3.486	1.549	3
4 Volt @ 85°C													
TPMD337*004#0025	D	330	4	85	2.7	125	13.2	8	25	3.194	2.874	1.277	3
TPMD337*004#0035	D	330	4	85	2.7	125	13.2	8	35	2.699	2.429	1.080	3
TPMD477*004#0025	D	470	4	85	2.7	125	18.8	8	25	3.194	2.874	1.277	3
TPMD477*004#0035	D	470	4	85	2.7	125	18.8	8	35	2.699	2.429	1.080	3
TPMD687*004#0025	D	680	4	85	2.7	125	27.2	8	25	3.194	2.874	1.277	3
TPME687*004#0018	E	680	4	85	2.7	125	27	6	18	3.873	3.486	1.549	3
TPME687*004#0023	E	680	4	85	2.7	125	27	6	23	3.426	3.084	1.370	3
TPMD108*004#0025	D	1000	4	85	2.7	125	40	8	25	3.194	2.874	1.277	3
TPMD108*004#0045	D	1000	4	85	2.7	125	40	8	45	2.380	2.142	0.952	3
TPME108*004#0018	E	1000	4	85	2.7	125	40	6	18	3.873	3.486	1.549	3
TPME108*004#0023	E	1000	4	85	2.7	125	40	6	23	3.426	3.084	1.370	3
TPMU108*004R0018	U	1000	4	85	2.7	125	40	6	18	4.048	3.643	1.619	3
TPMU108*004R0023	U	1000	4	85	2.7	125	40	6	23	3.581	3.223	1.433	3
TPMV108*004#0018	V	1000	4	85	2.7	125	40	6	18	3.979	3.581	1.592	3
TPME158*004#0015	E	1500	4	85	2.7	125	60	6	15	4.243	3.818	1.697	3
TPME158*004#0018	E	1500	4	85	2.7	125	60	6	18	3.873	3.486	1.549	3
6.3 Volt @ 85°C													
TPMY227M006#0030	Y	220	6.3	85	4	125	13.2	6	30	2.646	2.381	1.058	3
TPMD337*006#0025	D	330	6.3	85	4	125	19.8	8	25	3.194	2.874	1.277	3
TPMD337*006#0035	D	330	6.3	85	4	125	19.8	8	35	2.699	2.429	1.080	3
TPMD477*006#0030	D	470	6.3	85	4	125	28.2	8	30	2.915	2.624	1.166	3
TPME477*006#0018	E	470	6.3	85	4	125	28	6	18	3.873	3.486	1.549	3
TPME477*006#0023	E	470	6.3	85	4	125	28	6	23	3.426	3.084	1.370	3
TPME477*006#0030	E	470	6.3	85	4	125	28	6	30	3.000	2.700	1.200	3
TPME687*006#0018	E	680	6.3	85	4	125	41	6	18	3.873	3.486	1.549	3
TPME687*006#0023	E	680	6.3	85	4	125	41	6	23	3.426	3.084	1.370	3
TPMU687*006R0018	U	680	6.3	85	4	125	41	6	18	4.048	3.643	1.619	3
TPMU687*006R0023	U	680	6.3	85	4	125	41	6	23	3.581	3.223	1.433	3
TPMV687*006#0023	V	680	6.3	85	4	125	41	6	23	3.520	3.168	1.408	3
TPME108M006#0025	E	1000	6.3	85	4	125	63	8	25	3.286	2.958	1.315	3
TPMV108M006#0020	V	1000	6.3	85	4	125	63	8	20	3.775	3.397	1.510	3
10 Volt @ 85°C													
TPMY107M010#0045	Y	100	10	85	7	125	10	8	45	2.160	1.944	0.864	3
TPMY157M010#0045	Y	150	10	85	7	125	15	8	45	2.160	1.944	0.864	3
TPMD227*010#0035	D	220	10	85	7	125	22	8	35	2.699	2.429	1.080	3
TPMD337*010#0035	D	330	10	85	7	125	33	8	35	2.699	2.429	1.080	3
TPME337*010#0023	E	330	10	85	7	125	33	6	23	3.426	3.084	1.370	3
TPME337*010#0035	E	330	10	85	7	125	33	6	35	2.777	2.500	1.111	3
TPME477*010#0023	E	470	10	85	7	125	47	6	23	3.426	3.084	1.370	3
TPME477*010#0030	E	470	10	85	7	125	47	6	30	3.000	2.700	1.200	3
TPMU477*010R0023	U	470	10	85	7	125	47	8	23	3.581	3.223	1.433	3
TPMU477*010R0030	U	470	10	85	7	125	47	8	30	3.136	2.822	1.254	3
16 Volt @ 85°C													
TPMD476*016#0100	D	47	16	85	10	125	7.5	8	100	1.597	1.437	0.639	3
TPMD686*016#0040	D	68	16	85	10	125	10.9	8	40	2.525	2.272	1.010	3
TPMD686*016#0050	D	68	16	85	10	125	10.9	8	50	2.258	2.032	0.903	3
TPMD107*016#0040	D	100	16	85	10	125	16	8	40	2.525	2.272	1.010	3
TPMD107*016#0050	D	100	16	85	10	125	16	8	50	2.258	2.032	0.903	3
TPME157*016#0030	E	150	16	85	10	125	24	6	30	3.000	2.700	1.200	3
TPME157*016#0040	E	150	16	85	10	125	24	6	40	2.598	2.338	1.039	3
TPME227*016#0025	E	220	16	85	10	125	35	6	25	3.286	2.958	1.315	3
TPME227*016#0040	E	220	16	85	10	125	35	6	40	2.598	2.338	1.039	3
TPMU227*016R0030	U	220	16	85	10	125	35	8	30	3.136	2.822	1.254	3
TPMU227*016R0040	U	220	16	85	10	125	35	8	40	2.716	2.444	1.086	3
TPME337*016#0050	E	330	16	85	10	125	52.8	10	50	2.324	2.091	0.930	3
20 Volt @ 85°C													
TPMD476*020#0045	D	47	20	85	13	125	9.4	8	45	2.380	2.142	0.952	3
TPMD476*020#0055	D	47	20	85	13	125	9.4	8	55	2.153	1.938	0.861	3
TPME107*020#0035	E	100	20	85	13	125	20	6	35	2.777	2.500	1.111	3
TPME107*020#0045	E	100	20	85	13	125	20	6	45	2.449	2.205	0.980	3
TPME157*020#0035	E	150	20	85	13	125	30	10	35	2.777	2.500	1.111	3

TPM Multianode

Tantalum Ultra Low ESR Capacitor



RATINGS & PART NUMBER REFERENCE

AVX Part No.	Case Size	Capacitance (µF)	Rated Voltage (V)	Rated Temperature (°C)	Category Voltage (V)	Category Temperature (°C)	DCL Max. (µA)	DF Max. (%)	ESR Max. @ 100kHz (mΩ)	100kHz RMS Current (A)			MSL
										25°C	85°C	125°C	
25 Volt @ 85°C													
TPMD336*025#0065	D	33	25	85	17	125	8.3	8	65	1.981	1.783	0.792	3
TPMD476*025#0055	D	47	25	85	17	125	11.8	8	55	2.153	1.938	0.861	3
TPME476*025#0065	E	47	25	85	17	125	11.8	6	65	2.038	1.834	0.815	3
TPME686*025#0045	E	68	25	85	17	125	17	6	45	2.449	2.205	0.980	3
TPME686*025#0055	E	68	25	85	17	125	17	6	55	2.216	1.994	0.886	3
TPME107*025#0045	E	100	25	85	17	125	25	14	45	2.449	2.205	0.980	3
TPME107*025#0060	E	100	25	85	17	125	25	14	60	2.121	1.909	0.849	3
35 Volt @ 85°C													
TPMD226*035#0070	D	22	35	85	23	125	7.7	8	70	1.909	1.718	0.763	3
TPME226*035#0060	E	22	35	85	23	125	8	6	60	2.121	1.909	0.849	3
TPME226*035#0100	E	22	35	85	23	125	8	6	100	1.643	1.479	0.657	3
TPME336*035#0050	E	33	35	85	23	125	12	6	50	2.324	2.091	0.930	3
TPME336*035#0065	E	33	35	85	23	125	12	6	65	2.038	1.834	0.815	3
TPME476*035#0055	E	47	35	85	23	125	16	6	55	2.216	1.994	0.886	3
TPME476*035#0065	E	47	35	85	23	125	16	6	65	2.038	1.834	0.815	3
50 Volt @ 85°C													
TPMD106*050#0140	D	10	50	85	33	125	5	8	140	1.350	1.215	0.540	3
TPME106*050#0120	E	10	50	85	33	125	5	6	120	1.500	1.350	0.600	3
TPME156*050#0075	E	15	50	85	33	125	7.5	6	75	1.897	1.708	0.759	3
TPME156*050#0100	E	15	50	85	33	125	7.5	6	100	1.643	1.479	0.657	3
TPME226*050#0075	E	22	50	85	33	125	11	8	75	1.897	1.708	0.759	3
TPME226*050#0100	E	22	50	85	33	125	11	8	100	1.643	1.479	0.657	3

Moisture Sensitivity Level (MSL) is defined according to J-STD-020

All technical data relates to an ambient temperature of +25°C. Capacitance and DF are measured at 120Hz, 0.5V RMS with a maximum DC bias of 2.2 volts.

DCL is measured at rated voltage after 5 minutes.

The EIA & CECC standards for low ESR Solid Tantalum Capacitors allow an ESR movement to 1.25 times catalogue limit post mounting.

For typical weight and composition see page 274.

NOTE: AVX reserves the right to supply higher voltage ratings or tighter tolerance part in the same case size, to the same reliability standards.

QUALIFICATION TABLE

TEST	TPM series (Temperature range -55°C to +125°C)									
	Condition			Characteristics						
Endurance	Apply rated voltage (Ur) at 85°C and / or category-voltage (Uc) at 125°C for 2000 hours through a circuit impedance of ≤0.1Ω/V. Stabilize at room temperature for 1-2 hours before measuring.			Visual examination	no visible damage					
				DCL	initial limit					
				ΔC/C	within ±10% of initial value					
				DF	initial limit					
				ESR	1.25 x initial limit					
Humidity	Store at 65°C and 95% relative humidity for 500 hours, with no applied voltage. Stabilize at room temperature and humidity for 1-2 hours before measuring.			Visual examination	no visible damage					
				DCL	1.5 x initial limit					
				ΔC/C	within ±10% of initial value					
				DF	1.2 x initial limit					
				ESR	1.25 x initial limit					
Temperature Stability	Step	Temperature°C	Duration(min)		+20°C	-55°C	+20°C	+85°C	+125°C	+20°C
	1	+20	15							
	2	-55	15	DCL	IL*	n/a	IL*	10 x IL*	12.5 x IL*	IL*
	3	+20	15	ΔC/C	n/a	+0/-10%	±5%	+10/-0%	+12/-0%	±5%
	4	+85	15	DF	IL*	1.5 x IL*	IL*	1.5 x IL*	2 x IL*	IL*
	5	+125	15	ESR	1.25 x IL*	2.5 x IL*	1.25 x IL*	1.25 x IL*	1.25 x IL*	1.25 x IL*
	6	+20	15							
Surge Voltage	Apply 1.3x category voltage (Uc) at 125°C for 1000 cycles of duration 6 min (30 sec charge, 5 min 30 sec discharge) through a charge / discharge resistance of 1000Ω			Visual examination	no visible damage					
				DCL	initial limit					
				ΔC/C	within ±5% of initial value					
				DF	initial limit					
				ESR	1.25 x initial limit					
Mechanical Shock	MIL-STD-202, Method 213, Condition C			Visual examination	no visible damage					
				DCL	initial limit					
				ΔC/C	within ±5% of initial value					
				DF	initial limit					
				ESR	initial limit					
Vibration	MIL-STD-202, Method 204, Condition D			Visual examination	no visible damage					
				DCL	initial limit					
				ΔC/C	within ±5% of initial value					
				DF	initial limit					
				ESR	initial limit					

*Initial Limit



The Important Information/Disclaimer is incorporated in the catalog where these specifications came from or available online at www.avx.com/disclaimer/ by reference and should be reviewed in full before placing any order.

TPM Multianode

Tantalum Ultra Low ESR Capacitor

AVX SOLID ELECTROLYTIC CAPACITOR ROADMAP

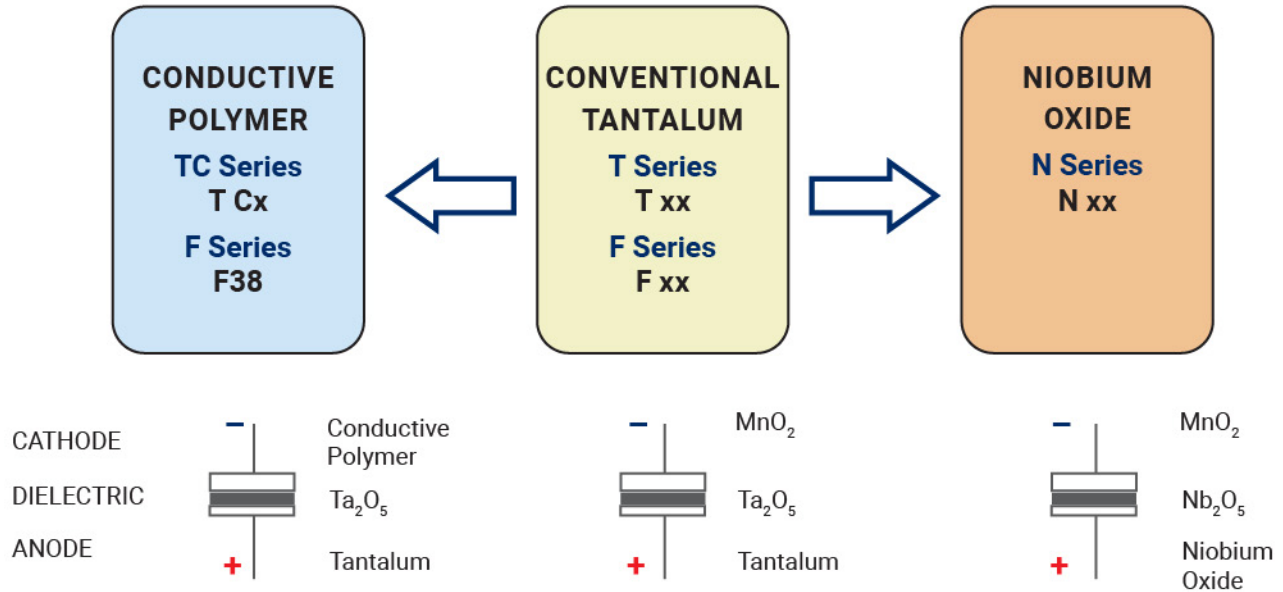

FIVE CAPACITOR CONSTRUCTION STYLES

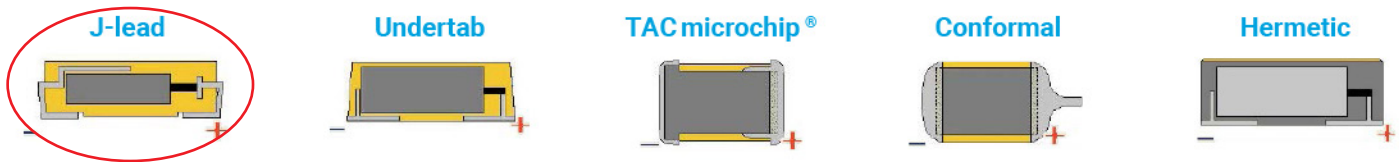

SERIES LINE UP : CONVENTIONAL SMD MnO₂

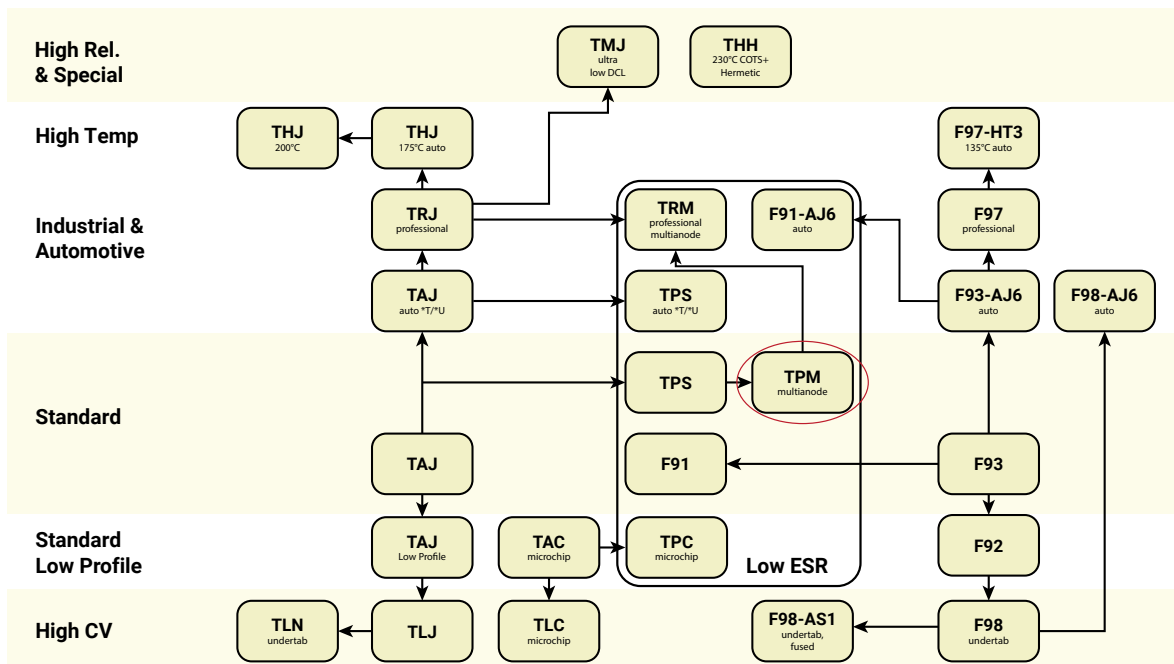

单击下面可查看定价，库存，交付和生命周期等信息

[>>AVX](#)