

AntennaGuard 0402/0603



AVX Low Capacitance Multilayer Varistors ESD Protection for Antennas and Low Capacitor Loading Applications

GENERAL DESCRIPTION

AVX's 0402/0603 AntennaGuard products are an ultra-low capacitance extension of the proven TransGuard® TVS (transient voltage suppression) line of multilayer varistors. RF designers now have a single chip option over conventional protection methods (passive filters with diode clamps), which not only gives superior performance over traditional schemes, but also provides the added benefits of reduced PCB real estate and lower installation costs.

AVX's AntennaGuard products are available in capacitance ratings of $\leq 3\text{pF}$ (0402 & 0603 chips), 2 and 12pF (0603 chip). These low capacitance values have low insertion loss, as well as give other TransGuard® advantages such as small size, sub-nanosecond response time, low leakage currents and unsurpassed reliability (FIT Rate of 0.2) compared to diodes.

RF antenna/RF amplifier protection against ESD events is a growing concern of RF circuit designers today, given the combination of increased signal "gain" demands, coupled with the required downsizing of the transistor package. The ability to achieve both objectives is tied to a reduced thickness of the SiO_2 gate insulator layer within the semiconductor. The corresponding result of such a change increases the Power Amplifier's (PA's) vulnerability to ESD strikes — a common event with handheld electronic products with RF transmitting and/or receiving features. AVX Low Capacitance AG Series parts are ideal solution for this type of applications as well as for many more where low capacitance ESD protection is needed.

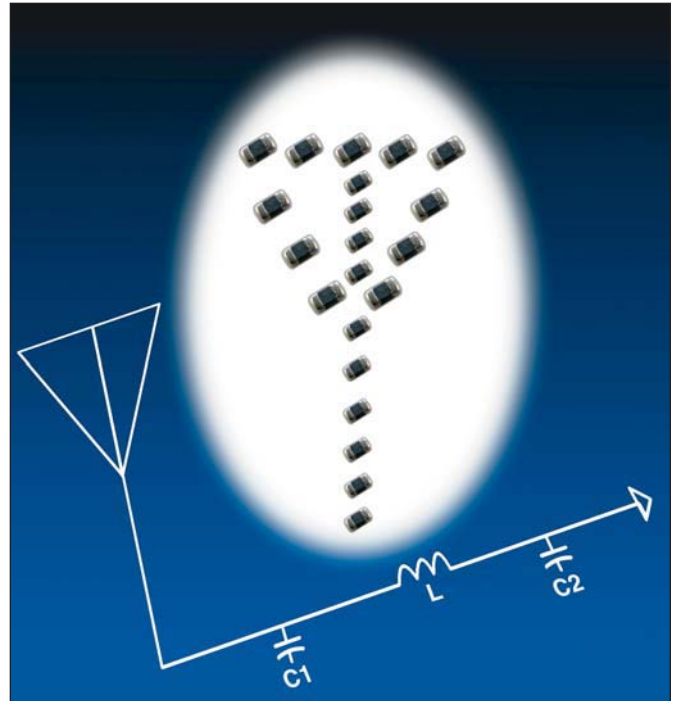

GENERAL CHARACTERISTICS

- Operating Temperature: -55°C to $+125^\circ\text{C}$
- Working Voltage: $\leq 18\text{Vdc}$
- Case Size: 0402, 0603

FEATURES

- Smallest TVS Component
- Single Chip Solution
- Low Insertion Loss
- Fastest Response Time to ESD Strikes
- Capacitance: 2, 3 and 12pF

APPLICATIONS

- RF Amplifiers
- Antennas
- Laser Drivers
- Sensors
- Radars
- RFID
- Keyless entry
- Near field communication
- Datalines
- Capacitance sensitive applications and more

HOW TO ORDER

VC	04	AG	18	3R0	Y	A	T	x	x
Varistor Chip	Chip Size	Varistor Series	Working Voltage (DC)	Capacitance	Non-Std. Cap Tolerance	Not Applicable	Termination	Reel Size	Reel Quantity
	04 = 0402 06 = 0603	AntennaGuard		2pF = 2R0 3pF = 3R0 12pF = 120	C = $\pm 0.25\text{pF}$ (2R0) Y = Max (3R0) Y = +4, -2pF (120)		T = Ni/Sn (Plated)	1 = 7" 3 = 13" W = 7" (0402 only)	A = 4,000 or 10,000 (i.e., 1A = 4,000 3A = 10,000) WA = 10,000



AntennaGuard 0402/0603



AVX Low Capacitance Multilayer Varistors

ESD Protection for Antennas and Low Capacitor Loading Applications

ANTENNAGUARD CATALOG PART NUMBERS/ELECTRICAL VALUES

AVX Part Number	V _w (DC)	V _w (AC)	I _L	Cap	Cap Tolerance	Case Size
VC04AG183R0YAT__	≤ 18	≤ 14	0.1	3	Max	0402
VC06AG182R0CAT__	≤ 18	≤ 14	0.1	2	±0.25pF	0603
VC06AG183R0YAT__	≤ 18	≤ 14	0.1	3	Max	0603
VC06AG18120YAT__	≤ 18	≤ 14	0.1	12	+4, -2pF	0603

Termination Finish Code
Packaging Code

V_w (DC) DC Working Voltage (V)

V_w (AC) AC Working Voltage (V)

I_L Maximum Leakage Current at the Working Voltage (μA)

Cap Maximum Capacitance (pF) @ 1 MHz and 0.5 Vrms; VC06AG18120YAT capacitance tolerance: +4, -2pF

PHYSICAL DIMENSIONS

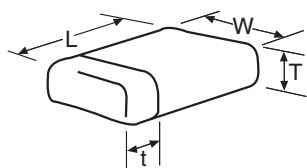

mm (inches)

Size (EIA)	Length (L)	Width (W)	Max Thickness (T)	Land Length (t)
0402	1.00±0.10 (0.040±0.004)	0.50±0.10 (0.020±0.004)	0.60 (0.024)	0.25±0.15 (0.010±0.006)
0603	1.60±0.15 (0.063±0.006)	0.80±0.15 (0.031±0.006)	0.90 (0.035)	0.35±0.15 (0.014±0.006)

SOLDERING PAD DIMENSIONS

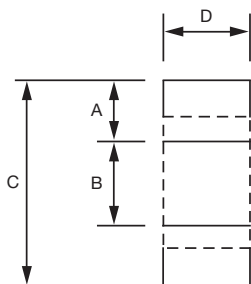

mm (inches)

Suppression Device	Pad Dimensions			
	A	B	C	D
AVX 0402	1.70 (0.067)	0.61 (0.024)	0.51 (0.020)	0.61 (0.024)
AVX 0603	2.54 (0.100)	0.89 (0.035)	0.76 (0.030)	0.89 (0.035)

AVX Low Capacitance Multilayer Varistors ESD Protection for Antennas and Low Capacitor Loading Applications

Antenna Varistors

AVX offers a series of 0402 and 0603 chip varistors, designated the AntennaGuard series, for RF antenna/RF amplifier protection. These devices offer ultra-low capacitance (<3pF in 0402 chips, and ≤3pF & ≤12pF in 0603 packages), as well as low insertion loss. Antenna varistors can replace output capacitors and provide ESD suppression in cell phones, pagers and wireless LANs.

It is very common to employ some form of a FET in many types of efficient/miniature RF amplifiers. Typically, these RF transistors have nearly ideal input gate impedance and outstanding noise figures. However, FETs are very susceptible to ESD damage due to the very thin layer of SiO₂ uses as the gate insulator. The ultra-thin SiO₂ layer is required to improve the gain of the transistor. In other words, the upside of the performance enhancement becomes the downside of the transistors survival when subjected to an ESD event.

ESD damage to the RF Field Effect Transistors (FETs) is a

growing concern among RF designers due to the following trends: (1) RF amplifiers continue to shrink in size, and (2) FET gains figures continue to increase. Both trends relate to decreasing gate oxide thickness, which in turn, is directly proportional to increased ESD sensitivity. As miniaturization trends accelerate, the traditional methods to protect against ESD damage (i.e., PC board layout, passive filters, and diode clamps) are becoming less and less effective.

AVX's AntennaGuard varistor can be used to protect the FET and offer superior performance to the previously mentioned protection methods given above. The standard EIA 0603 chip size, and particularly the 0402 chip, offer designers an ESD protection solution consistent with today's downsizing trend in portable electronic products. Savings in component volume up to 86%, and PC board footprint savings up to 83% are realistic expectations. These percentages are based upon the following table and Figures 1A and 1B.

mm (inches)

Suppression Device	Pad Dimensions				
	D1	D2	D3	D4	D5
AVX 0402 TransGuard®	1.70 (0.067)	0.61 (0.024)	0.51 (0.020)	0.61 (0.024)	0.51 (0.020)
AVX 0603 TransGuard®	2.54 (0.100)	0.89 (0.035)	0.76 (0.030)	0.89 (0.035)	0.76 (0.030)
Competitor's SOT23 Diode	See Below				

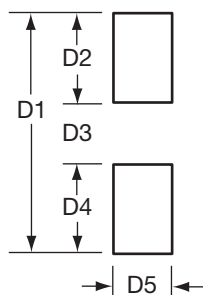

Figure 1A. 0402/0603 IR Solder Pad Layout

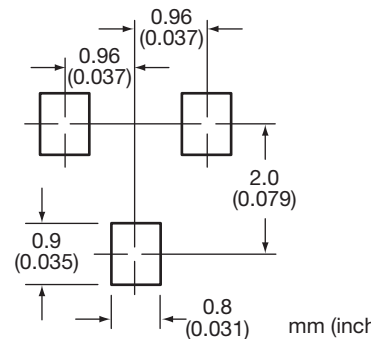

Figure 1B. SOT23- Solder Pad Layout

AntennaGuard 0402/0603



AVX Low Capacitance Multilayer Varistors ESD Protection for Antennas and Low Capacitor Loading Applications

Antenna varistors offer excellent ESD repetitive strike capability compared to a SOT23 diode when subjected to IEC 61000-4-2 8kV contact discharge. A performance summary is shown in Figure 2.

ESD TEST OF ANTENNAGUARD RATINGS

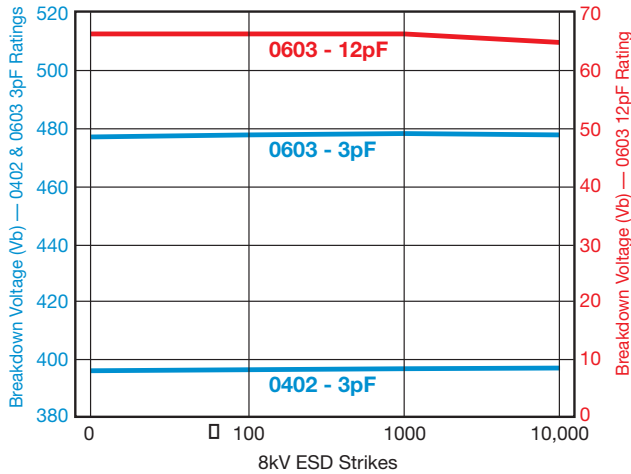

Figure 2. Repetitive 8kV ESD Strike

Antenna varistors also turn on and divert ESD overvoltages at a much faster rate than SOT23 devices (typically 300pS vs 1500pS - 5000pS). See Figure 3.

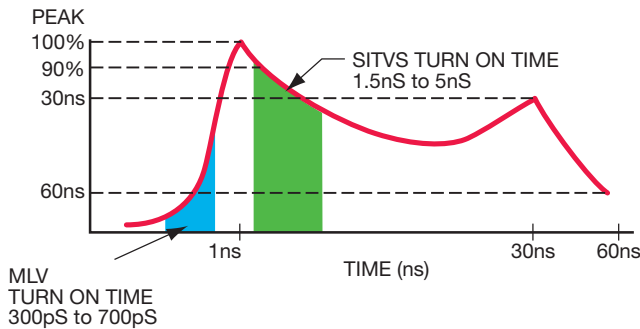

Figure 3. Turn On Time

The equivalent circuit model for a typical antenna varistor is shown in Figure 4.

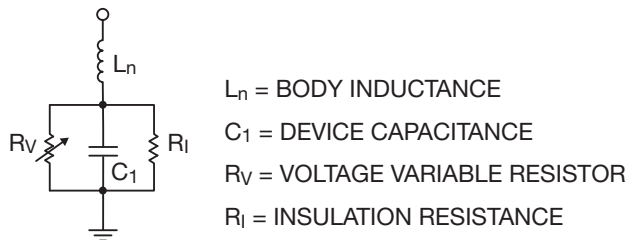

Figure 4. Antenna Varistor

The varistor shown exhibits a capacitance of $\leq 3\text{pF}$ which can be used to replace the parallel capacitance typically found prior to the antenna output of an RF amplifier. In the off state, the varistor acts as a capacitor and helps to filter RF output. The varistor is not affected by RF output power or voltage and has little insertion loss. See Figure 3.

ANTENNA VARISTOR S21

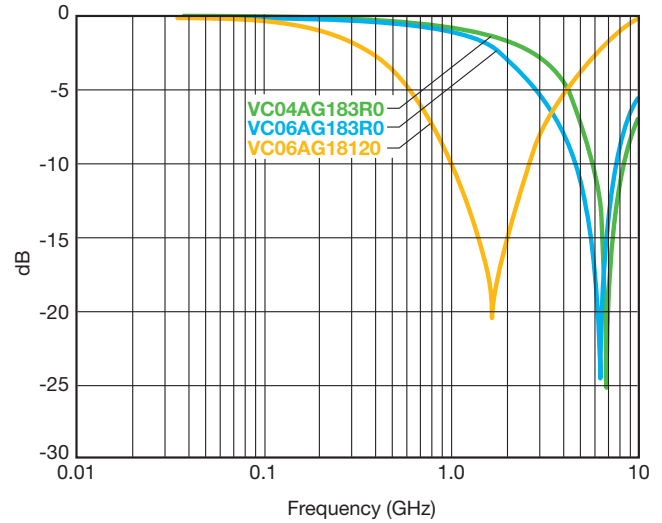

Figure 5. Antenna vs Frequency

Typical implementations of the antenna varistors are shown for use in cell phone, pager and wireless LAN applications in Figures 6A, 6B and 6C.

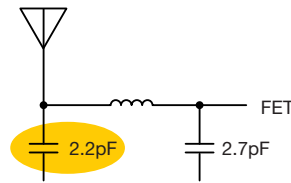

Figure 6A. Cell Phone

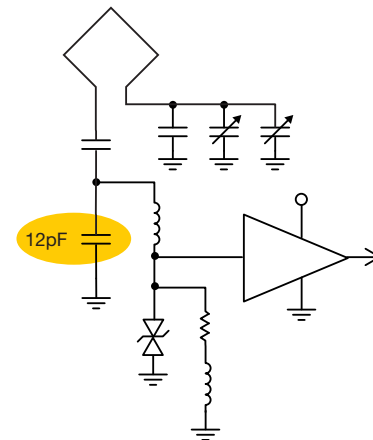

Figure 6B. Pager

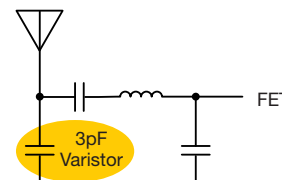

Figure 6C.

单击下面可查看定价，库存，交付和生命周期等信息

[>>AVX](#)