

I²S/TDM Input, 10.25V BOOST Digital Smart K Audio Amplifier with Speaker Voltage and Current Sense

FEATURES

- **Smart BOOST with total efficiency up to 84%**
- **High RF noise suppression, eliminate the TDD noise completely**
- **Low noise: 12uV**
- **THD+N: 0.02%**
- **Speaker Voltage and Current Sense**
- Supports 6Ω Speaker
- Extensive Pop-Click Suppression
- Volume control(from -96dB to 0dB)
- I²S/TDM interface:
 - I²S, Left-Justified and Right-Justified
 - Supports four slots TDM
 - Input Sample Rates from 8kHz to 96kHz
 - Data Width: 16, 20, 24, 32 Bits
- I²C-bus control interface(400kHz)
- Power Supplies:
 - VDD: 3.0V-5.5V
 - DVDD: 1.65V~1.95V
- Short-Circuit Protection, Over-Temperature Protection, Under-Voltage Protection and Over-Voltage Protection
- WLCSP 2.58X2.72-36B package

APPLICATIONS

- Mobile phones
- Tablets
- Portable Audio Devices

DESCRIPTION

The AW88263 is an I²S/TDM input, high efficiency digital Smart K audio amplifier with an integrated 10.25V smart boost converter. Due to its 12uV noise floor and ultra-low distortion, clean listening is guaranteed. It can deliver 5.2W output power into an 8Ω speaker at 1% THD+N.

The AW88263 integrates a high-efficiency smart boost converter as the Class-D amplifier supply rail. The output voltage of boost converter can be adjusted smartly according to the input amplitude, which extremely improves the efficiency without clipping distortion.

The AW88263 features high RF suppression and eliminates TDD noise completely benefited from the digital audio input interface. General settings are communicated via an I²C-bus interface, and the device address is configurable.

The AW88263 offers Short Circuit Protection, Over-Temperature Protection, Under-Voltage Protection and Over-Voltage Protection to protect the device.

AW88263 is available in a WLCSP 2.58X2.72-36B package.

PIN CONFIGURATION AND TOP MARK

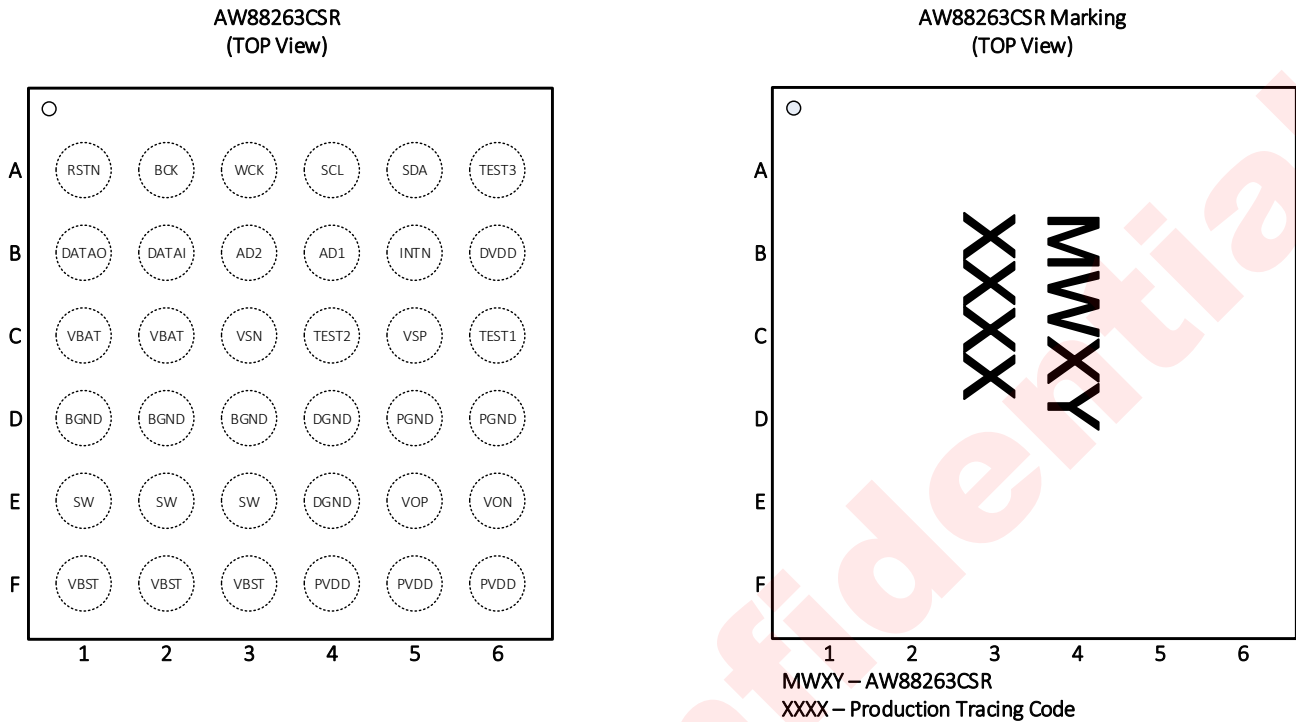

Figure 1 AW88263CSR pin diagram top view and device marking

PIN DESCRIPTION

Pin No	Pin Name	Description
A1	RSTN	Active low hardware reset
A2	BCK	I ² S/TDM bit clock input
A3	WCK	I ² S word select input / TDM frame sync signal
A4	SCL	I ² C clock input
A5	SDA	I ² C data IO
A6	TEST3	Test signal IO 3
B1	DATAO	I ² S/TDM data out
B2	DATAI	I ² S/TDM data input
B3	AD2	I ² C address select input 2
B4	AD1	I ² C address select input 1
B5	INTN	Interrupt output
B6	DVDD	Digital power supply
C1, C2	VBAT	Battery power supply
C3	VSN	Voltage sense inverting

Pin No	Pin Name	Description
C4	TEST2	Test signal IO 2
C5	VSP	Voltage sense non-inverting
C6	TEST1	Test signal IO 1
D1,D2,D3	BGND	Boost GND
D4,E4	DGND	Digital GND
D5,D6	PGND	Power GND
E1,E2,E3	SW	Boost switch pin
E5	VOP	Non-inverting Class-D output
E6	VON	Inverting Class-D output
F1,F2,F3	VBST	Boost output
F4,F5,F6	PVDD	Power supply voltage

FUNCTIONAL BLOCK DIAGRAM

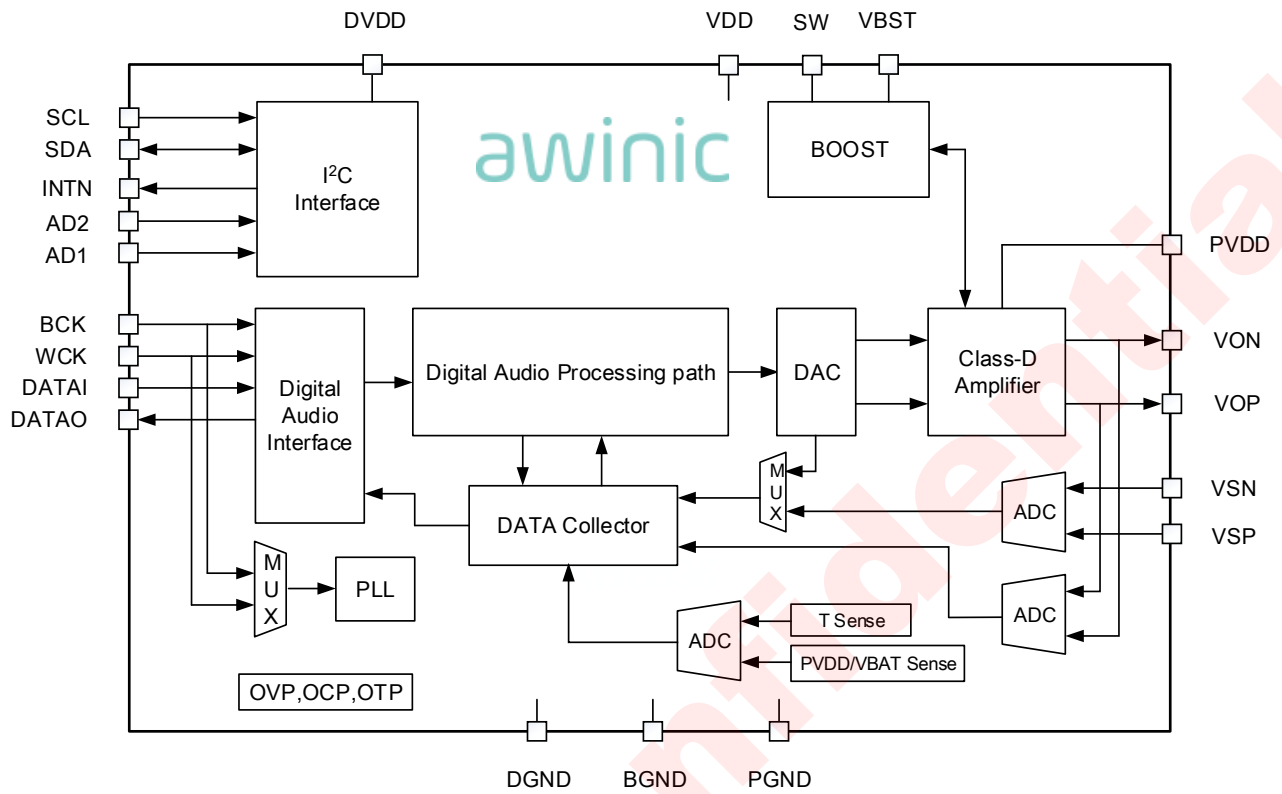

Figure 2 FUNCTIONAL BLOCK DIAGRAM

APPLICATION DIAGRAM

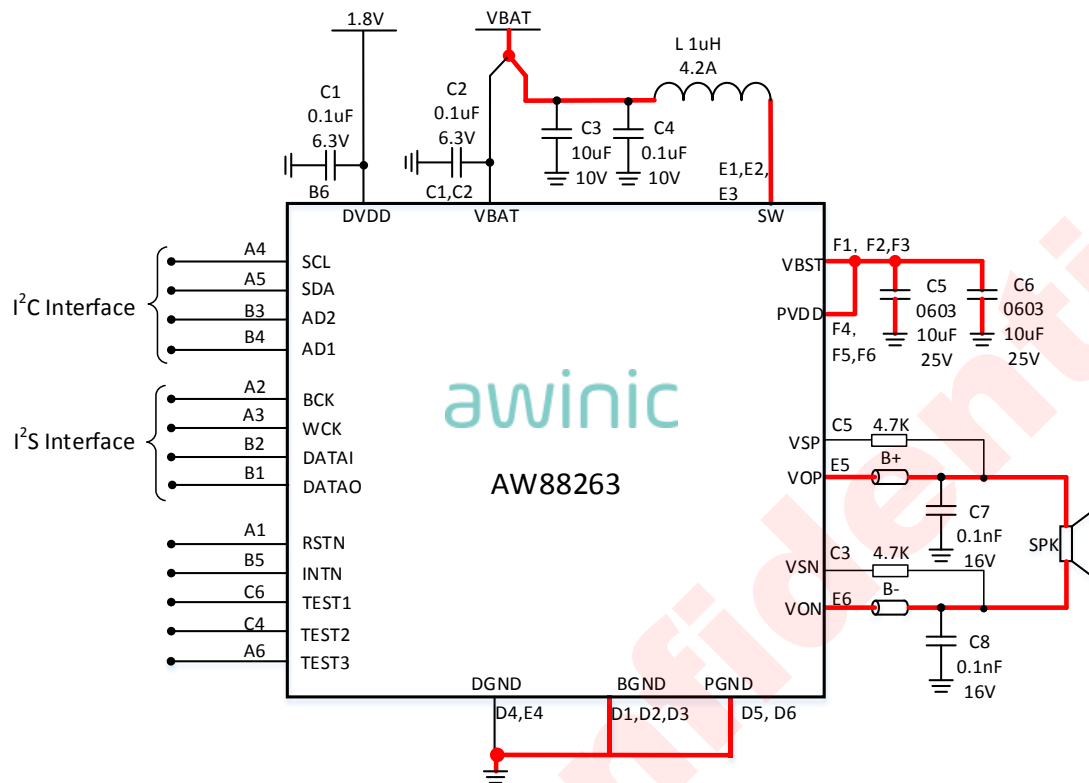

Figure 3 AW88263 Application Circuit

Note: Traces carry high current are marked in red in the above figure

All trademarks are the property of their respective owners.

ORDERING INFORMATION

Product Type	Temperature	Package	Device Marking	Moisture Sensitivity Level	Environmental Information	Delivery Form
AW88263CSR	-40°C ~ 85°C	WLCSP 2.58X2.72-36B	MWXY	MSL1	RoHS+HF	6000 units/ Tape and Reel

ABSOLUTE MAXIMUM RATING(NOTE1)

Parameter	Range
Battery Supply Voltage V_{DD}	-0.3V to 6V
Digital Supply Voltage V_{DVDD}	-0.3V to 2V
Boost output voltage V_{PVDD}	-0.3 to 13V
Boost SW pin voltage	-0.3 to $V_{PVDD}+2V$
Minimum load resistance R_L	5Ω
Package Thermal Resistance θ_{JA}	60°C/W
Ambient Temperature Range	-40°C to 85°C
Maximum Junction Temperature T_{JMAX}	165°C
Storage Temperature Range T_{STG}	-65°C to 150°C
Lead Temperature (Soldering 10 Seconds)	260°C
ESD Rating (Note 2,3)	
HBM (Human Body Model)	±3000V
CDM(Charge Device Model)	±1000V
Latch-up	
Test Condition: JEDEC STANDARD NO.78E SEPTEMBER 2016	+IT: 450mA -IT: -450mA

Note 1: Stresses beyond those listed under "absolute maximum ratings" may cause permanent damage to the device. These are stress ratings only and functional operation of the device at these or any other conditions beyond those indicated under "recommended operating conditions" is not implied. Exposure to absolute-maximum-rated conditions for extended periods may affect device reliability.

Note 2: The human body model is a 100pF capacitor discharged through a 1.5kΩ resistor into each pin. Test method: MIL - STD-883J Method 3015.9

Note 3: Test method: JEDEC EIA/JESD22-C101F

ELECTRICAL CHARACTERISTICS

CHARACTERISTICS

Test condition : $T_A=25^{\circ}\text{C}$, $V_{DD}=3.6\text{V}$, $DV_{DD}=1.8\text{V}$, $PV_{DD}=10.25\text{V}$, $R_L=8\Omega+33\mu\text{H}$, $f=1\text{kHz}$ (unless otherwise noted)

Symbol	Description	Test Conditions	Min	Typ.	Max	Units
V_{DD}	Battery supply voltage	On pin VDD	3		5.5	V
DV_{DD}	Digital supply voltage	On pin DVDD	1.65	1.8	1.95	V
I_{VDD}	Battery supply current	Operating mode		5.5		mA
		Power down mode		0.3	2	μA
I_{DVDD}	Digital supply current	Operating mode		4.5		mA
		Power down mode		5		μA
Boost						
V_{PVDD}	Boost output voltage			10.25 ^(Note1)		V
V_{OVP}	Over-voltage threshold			$V_{PVDD}+0.5$		V
	OVP hysteresis voltage			500		mV
I_{L_PEAK}	Inductor peak current limit			3.75 ^(Note1)		A
F_{BST}	Operating Frequency	$f_s = 48\text{KHz}$		1.6		MHz
D_{MAX}	The maximum duty cycle			90		%
η_{BST}	Boost converter efficiency	$V_{DD}=4.2\text{V}$, $I_{load} = 0.5\text{A}$ SmartBoost		88		%
Class-D						
R_{dson}	Drain-Source on-state resistance	High side MOS + Low side MOS		300		m Ω
P_o	Speaker Output Power	THD+N=1%, $R_L=8\Omega+33\mu\text{H}$, $V_{DD}=4.2\text{V}$, $PV_{DD}=10.25\text{V}$		5.2		W
		THD+N=10%, $R_L=8\Omega+33\mu\text{H}$, $V_{DD}=4.2\text{V}$, $PV_{DD}=10.25\text{V}$		6.2		W
		THD+N=1%, $R_L=6\Omega+33\mu\text{H}$, $V_{DD}=4.2\text{V}$, $PV_{DD}=10.25\text{V}$		5.35		W
		THD+N=10%, $R_L=6\Omega+33\mu\text{H}$, $V_{DD}=4.2\text{V}$, $PV_{DD}=10.25\text{V}$		6.5		W
V_{OS}	Output offset voltage	I ² S signal input 0	-30	0	30	mV
η	Total efficiency	$V_{DD}=4.2\text{V}$, $P_o=0.5\text{W}$, $R_L=8\Omega+33\mu\text{H}$		89		%

Symbol	Description	Test Conditions		Min	Typ.	Max	Units
	(Class-D)						
	Total efficiency (SmartBoost+Class-D)	V _{DD} =4.2V, P _o =1W, R _L =8Ω+33μH			84		%
THD+N	Total harmonic distortion plus noise	V _{DD} =4.2V, P _o =1W, R _L =8Ω+33μH, f=1kHz, PVDD=10.25V			0.02		%
E _N	Speaker Mode Output noise	A-weighting			22		μV
	Receiver Mode Output noise	A-weighting			12		μV
SNR	Signal-to-noise ratio	V _{DD} =4.2V, PVDD=10.25V, P _o =5.2W, R _L =8Ω+33μH, A-weighting			109		dB
PSRR	Power supply rejection ratio	Receiver Mode , V _{DD} =4.2V, V _{p-p,sin} =200mV	217Hz		-85		dB
			1kHz		-80		dB
Current Sense							
I _{SNS_FS}	Current sense full scale				3.67		A
SNR	Signal-to-noise ratio	I _{peak} =1A, R _L =8Ω+33μH, A-weighting			65		dB
THD+N	Total harmonic distortion plus noise	I _{peak} =1A, R _L =8Ω+33μH			0.25		%
ΔI _{SNS}	Current sense accuracy	I _{peak} =1A, R _L =8Ω+33μH			2		%
Voltage Sense							
V _{SNS_FS}	Voltage sense full scale				18		V
SNR	Signal-to-noise ratio	I _{peak} =1A, R _L =8Ω+33μH, A-weighting			65		dB
THD+N	Total harmonic distortion plus noise	I _{peak} =1A, R _L =8Ω+33μH			0.1		%
ΔV _{SNS}	Voltage sense accuracy	I _{peak} =1A, R _L =8Ω+33μH			2		%
Digital Logical Interface							
V _{IL}	Logic input low level	BCK, WCK, DATA1 Pin				0.3 x V _{DVDD}	V
V _{IH}	Logic input high level			0.7 x V _{DVDD}		V _{DVDD}	V
V _{IL}	Logic input low level	RSTN, SCL, SDA, AD1, AD2 Pin				0.3 x V _{DVDD}	V
V _{IH}	Logic input high level			0.7 x V _{DVDD}		3.6	V
V _{OL}	Logic output low level	I _{out} =2mA				0.45	V

Symbol	Description	Test Conditions	Min	Typ.	Max	Units
V _{OH}	Logic output high level	I _{OUT} =-2mA	V _{DVDD} - 0.45		V _{DVDD}	V
Protection						
T _{SD}	Over temperature protection threshold			160		°C
T _{SDR}	Over temperature protection recovery threshold			130		°C
UVP	Under-voltage protection voltage			2.6		V
	Under-voltage protection hysteresis voltage			100		mV

Note 1: Registers are adjustable; Refer to the list of registers.

I²C INTERFACE TIMING

Parameter			MIN	TYP	MAX	UNIT
No.	Sym	Name				
1	f _{SCL}	SCL Clock frequency			400	kHz
2	t _{LOW}	SCL Low level Duration	1.3			μs
3	t _{HIGH}	SCL High level Duration	0.6			μs
4	t _{RISE}	SCL, SDA rise time			0.3	μs
5	t _{FALL}	SCL, SDA fall time			0.3	μs
6	t _{SU:STA}	Setup time SCL to START state	0.6			μs
7	t _{HD:STA}	(Repeat-start) Start condition hold time	0.6			μs
8	t _{SU:STO}	Stop condition setup time	0.6			μs
9	t _{BUF}	the Bus idle time START state to STOP state	1.3			μs
10	t _{SU:DAT}	SDA setup time	0.1			μs
11	t _{HD:DAT}	SDA hold time	10			ns

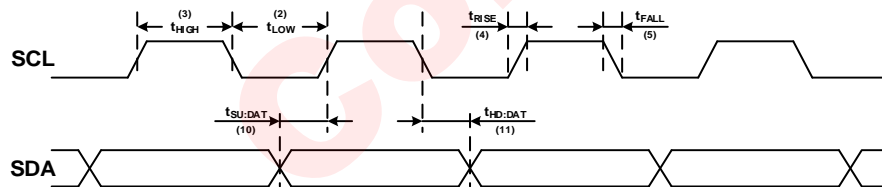

Figure 4 SCL and SDA timing relationships in the data transmission process

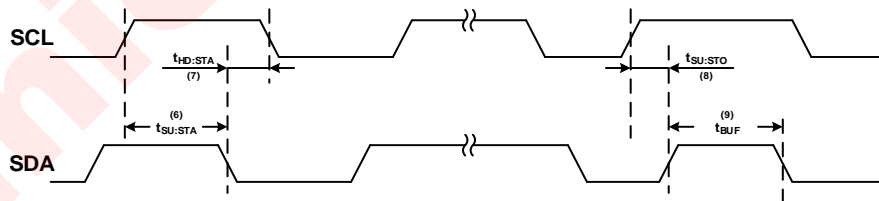

Figure 5 The timing relationship between START and STOP state

DIGITAL AUDIO INTERFACE TIMING

Parameter Name		Min	Typ.	Max	Units
f_s	sampling frequency, on pin WCK	8		96	kHz
f_{bck}	Bit clock frequency, on pin BCK	$32 \cdot f_s$		$128 \cdot f_s$	Hz
t_{su}	WCK, DATAI Setup time to BCK	10			ns
t_h	WCK, DATAI hold time to BCK	10			ns
t_d	DATAO output delay time to BCK			50	ns

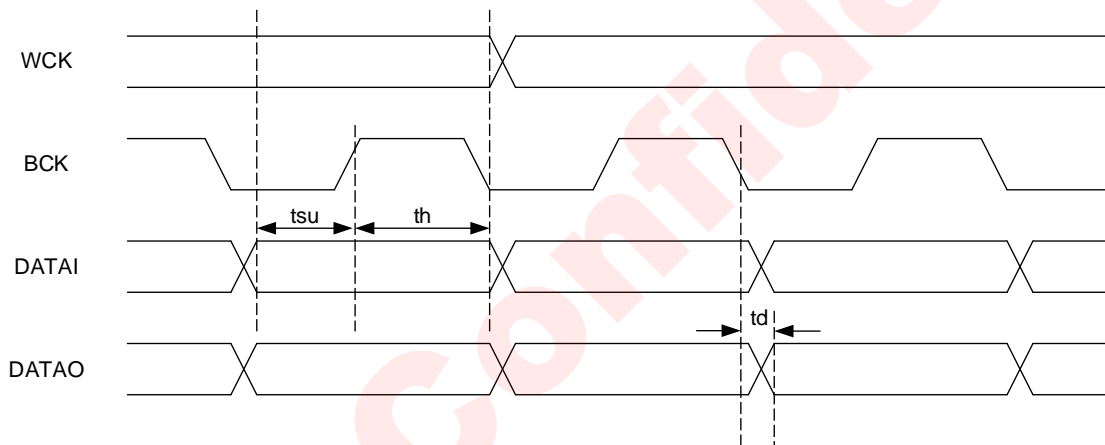
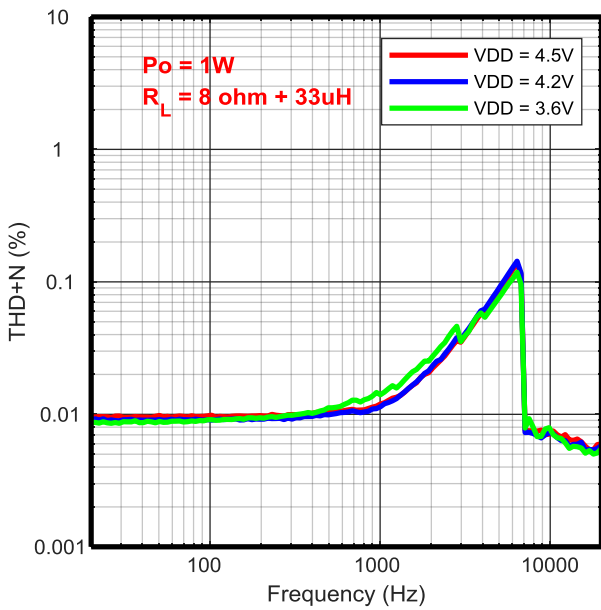

Figure 6 Digital Audio Interface Timing

TYPICAL CHARACTERISTIC CURVES

THD+N VS. FREQUENCY



THD+N VS. FREQUENCY

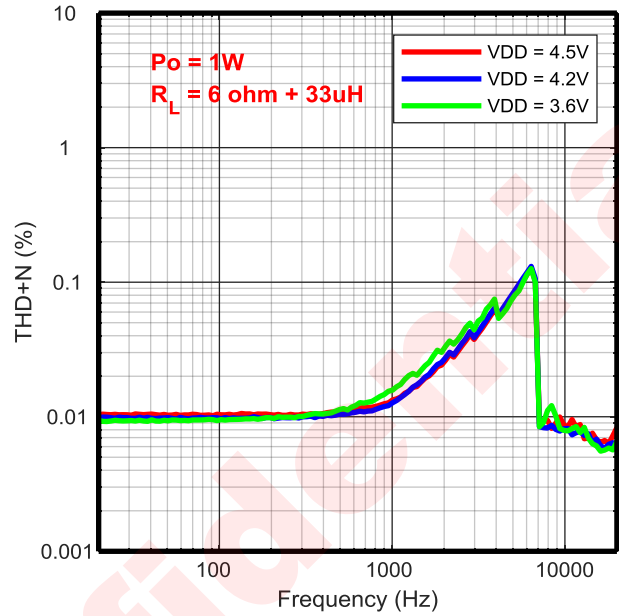

THD+N VS. OUTPUT POWER

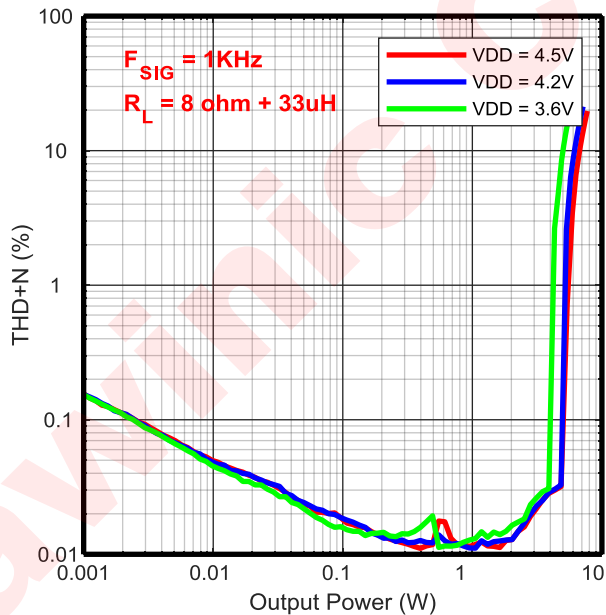

THD+N VS. OUTPUT POWER

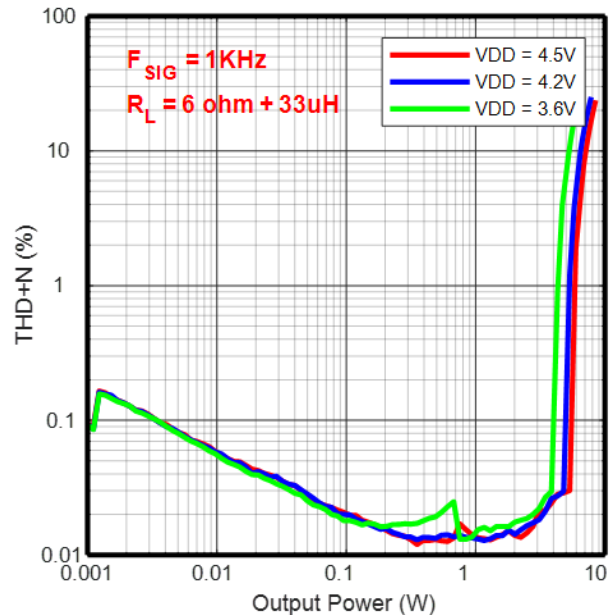

GAIN VS. FREQUENCY

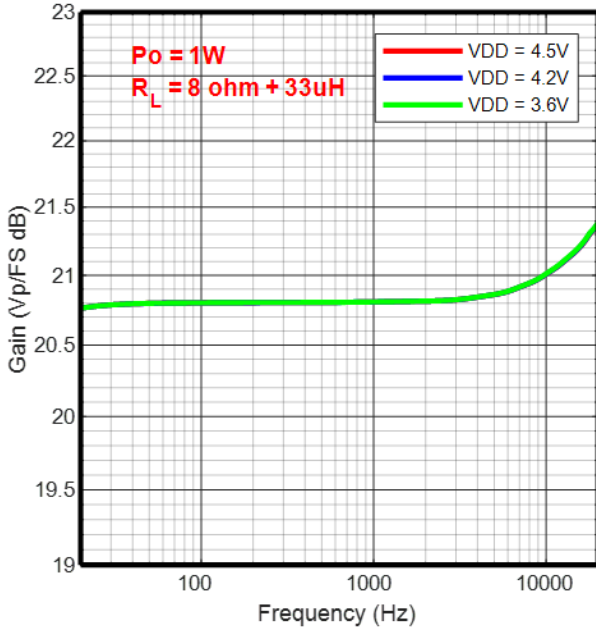

OUTPUT POWER VS. Din

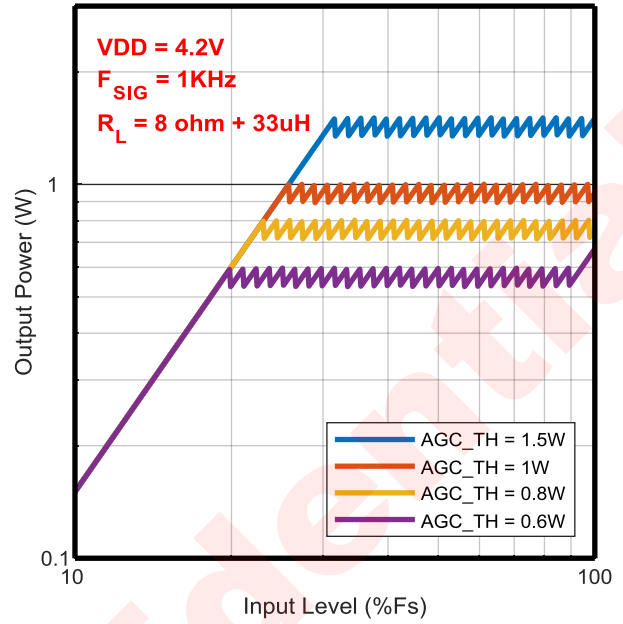

EFFICIENCY VS. OUTPUT POWER

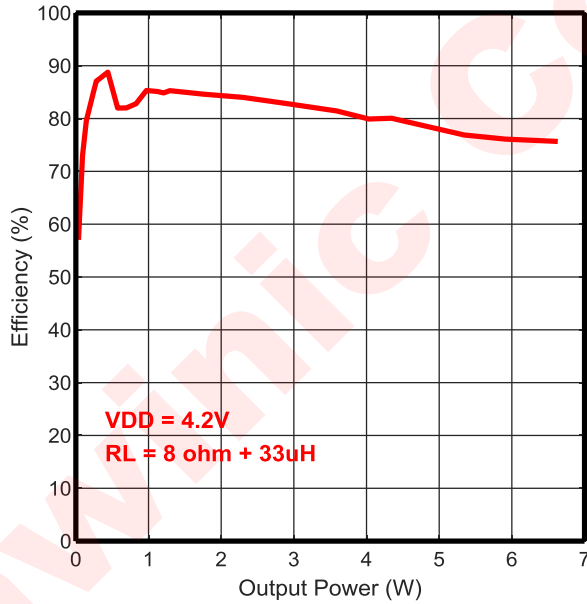

EFFICIENCY VS. OUTPUT POWER

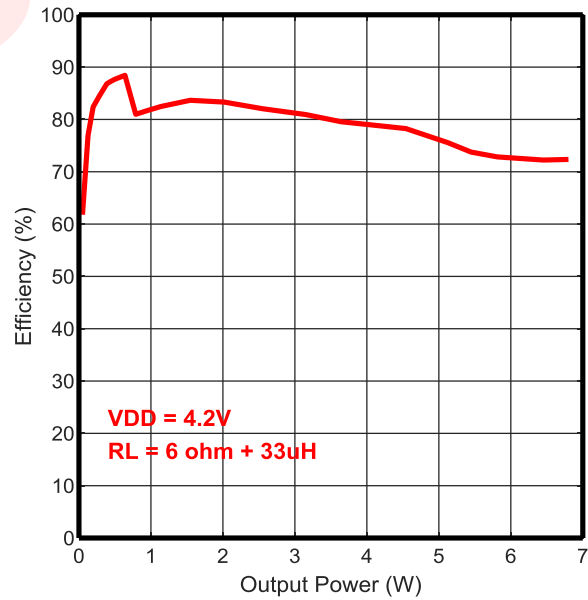

RECEIVER PSRR VS. FREQUENCY

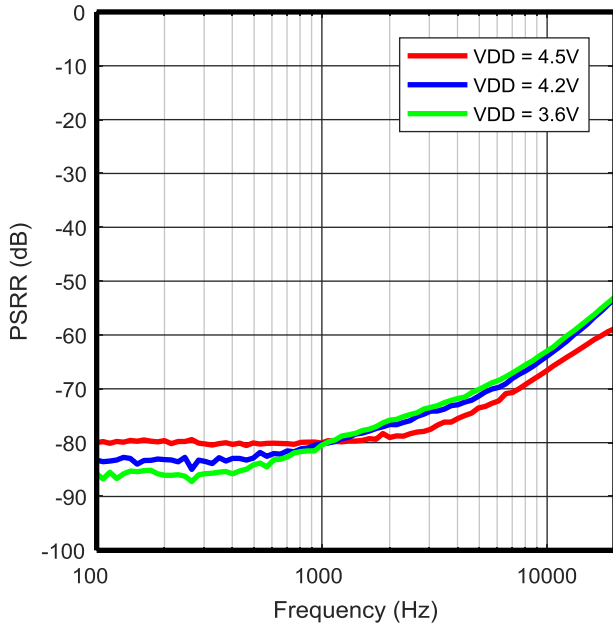

awinic Confidential

DETAIL FUNCTIONAL DESCRIPTION

POWER ON RESET

The device provides a power-on reset feature that is controlled by VDD and DVDD supply voltage. When the VDD supply voltage raises from 0V to 2.1V, or DVDD supply voltage raises from 0V to 1.1V. The reset signal will be generated to perform a power-on reset operation, which will reset all circuits and configuration registers.

OPERATION MODE

The device supports 4 operation modes.

Table 1 Operating Mode

Mode	Condition	Description
Power-Down	$V_{DD} < 2.1V$ $V_{DVDD} < 1.1V$	Power supply is not ready, chipset is power down.
Stand-By	$V_{DD} > 3V$ $V_{DVDD} > 1.65V$	Power supply is ready, most parts of the device are power down for low power consumption except I ² C interface
Configuring	PWDN = 0	Device is biased while boost and class-D output is floating. System configuration carried out in this mode
Operating	AMPPD = 0	Amplifier is fully operating

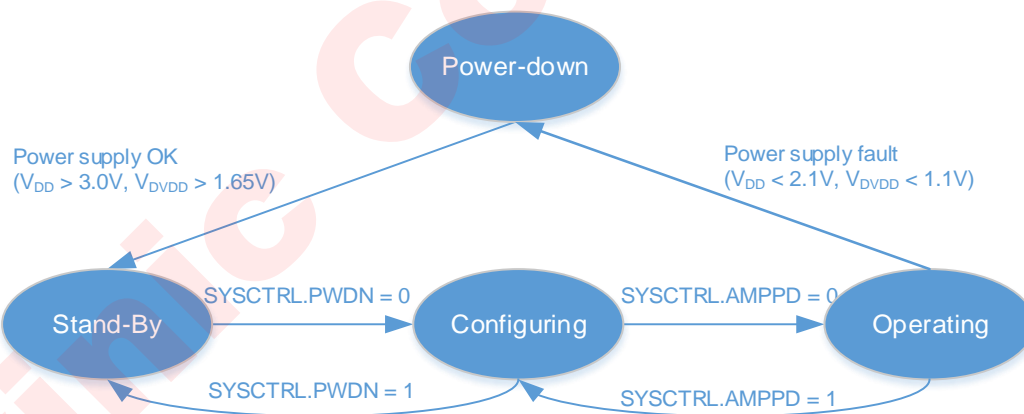

Figure 7 Device operating modes transition

POWER-DOWN MODE

The device switches to power-down mode when any of the following events occurred:

- $V_{DVDD} < 1.1V$
- $V_{DD} < 2.1V$
- RSTN pin goes LOW

In this mode, all circuits inside this device will be shut down except the power-on-reset circuit. I²C interface isn't accessible in this mode, and all of the internal configurable registers are cleared.

The device will jump out of the power-down mode automatically when all of the supply voltages are OK:

$$V_{bVDD} > 1.65\text{ V and } V_{DD} > 3\text{ V}$$

And RSTN goes HIGH.

STAND-BY MODE

The device switches stand-by mode when the power supply voltages are OK and RSTN pin is HIGH. In this mode I²C interface is accessible, other modules are still powered down. Customer can set device to mode when the device is no needed to work.

CONFIG MODE

The device switches to OFF mode when:

- SYSCTRL.PWDN = 0;
- SYSCTRL.AMPPD = 1;

In this mode the internal bias, OSC, PLL will start to work

OPERATING MODE

The device is fully operational in this mode. Boost, amplifier loop and power stage circuits will start to work. Customer can set SYSCTRL.AMPPD = 0 to make device in this mode.

This device power up sequence is illustrated in the following figure:

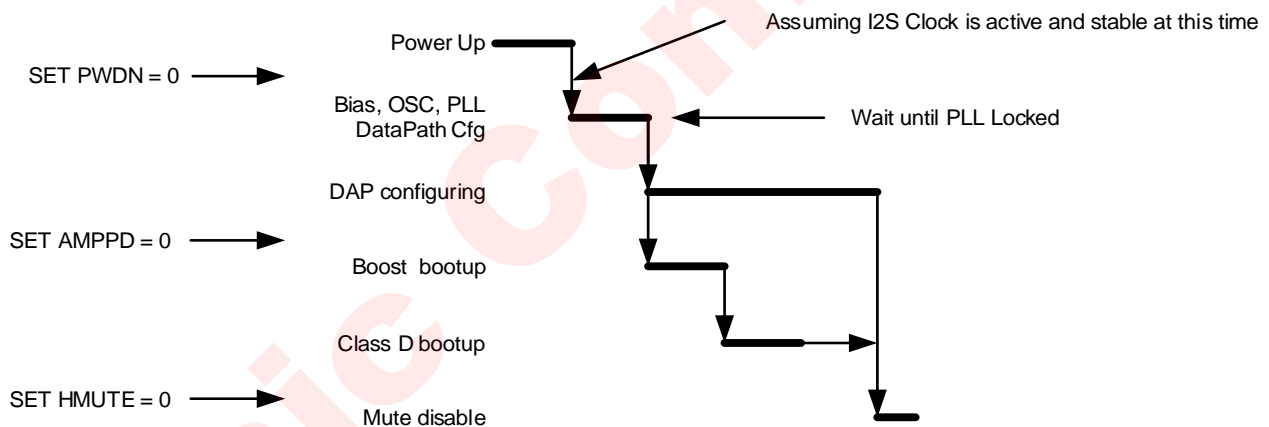

Figure 8 Power up sequence

Detail description for each step is listed in the following table.

Table 2 Detail Description of Power up sequence

Index	description	Mode
1	Wait for VDD、DVDD supply power up	Power-Down
2	I ² S + Data Path Configuration	Stand-By
3.1	Enable system (SYSCTRL.PWDN = 0)	Configuring
3.2	Bias, OSC, PLL active	
3.3	Waiting for PLL locked	
4.1	Enable Boost and amplifier (SYSCTRL.AMPPD = 0) Boost and Amplifier boot up	Operating
4.2	wait SYSST.SWS = 1	
5	Release Hard-Mute Data Path active	

Power up sequence considering I²S, I²C timing shows as below:

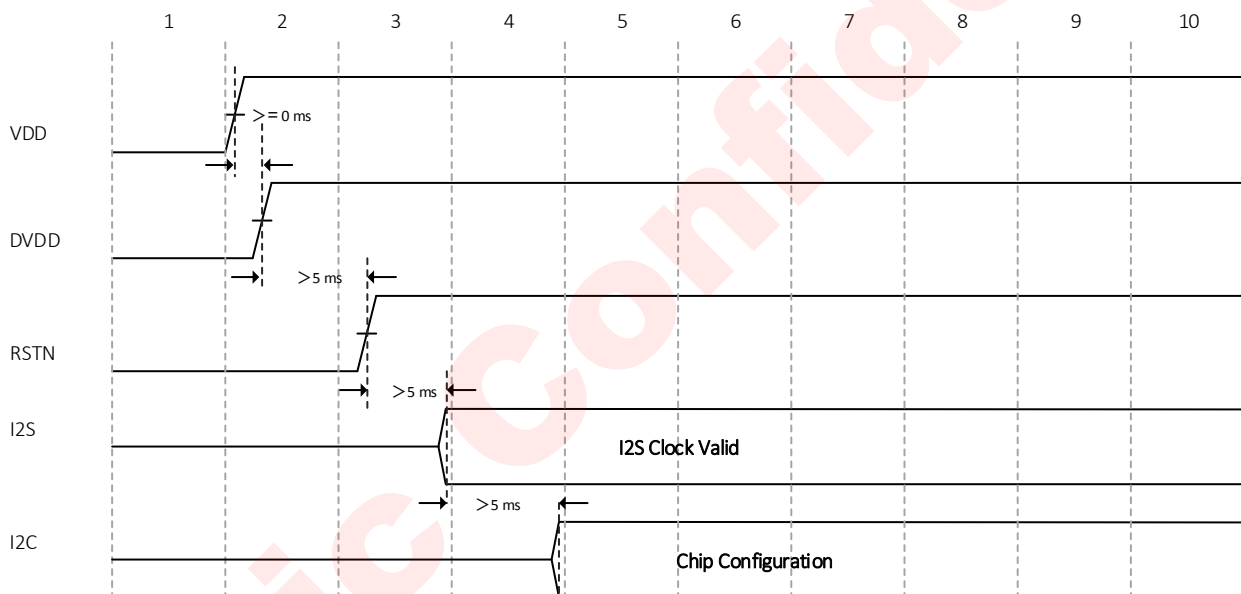

Power down sequence considering I²S, I²C timing shows as below:

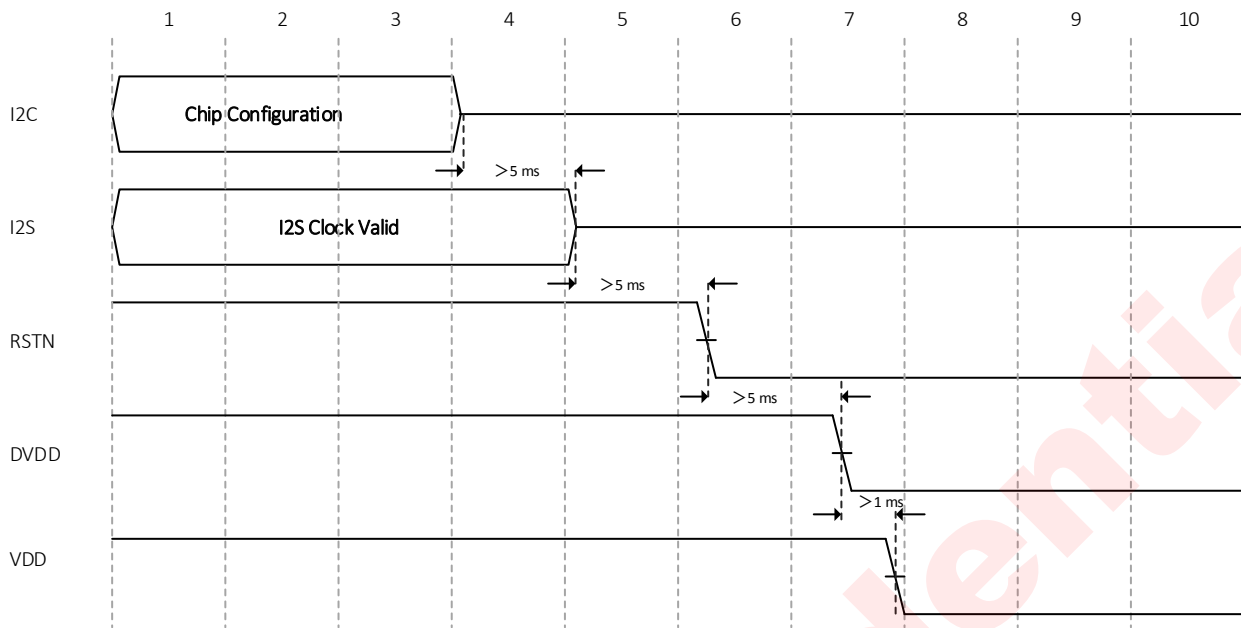

SOFTWARE RESET

Writing 0x55AA to register ID (0x00) via I²C interface will reset the device internal circuits and all configuration registers.

DIGITAL AUDIO INTERFACE

Audio data is transferred between the host processor and the device via the Digital Audio Interface. The digital audio interface is in full-duplex via 4 dedicated pins:

- BCK
- WCK
- DATAI
- DATAO

Two-slot I²S and 4-slot TDM are supported in this device. The digital audio Interface on this device is slave only and flexible with data width options, including 16, 20, 24, or 32 bits by configurable registers.

Three modes of I²S are supported, including standard I²S mode, left-justified mode and right-justified data mode, which can be configured via I2SCTRL.I2SMD. These modes are all MSB-first, with data width programmable via I2SCTRL.I2SFS.

The word clock WCK is used to define the beginning of a frame. The frequency of this clock corresponds to the sampling frequency. The device supports the following sample rates (fs): 8 kHz, 11.025 kHz, 12 kHz, 16 kHz, 22.05 kHz, 24 kHz, 32 kHz, 44.1 kHz, 48 kHz and 96 kHz. It is selected via configurable register I2SCTRL.I2SSR.

The bit clock BCK is used to sample the digital audio data across the digital audio interface. The number of bit-clock pulses in a frame is defined as slot length. Three kind of slot length are supported (16/24/32) via configurable register I2SCTRL.I2SBCK. The frequency of BCK can be calculated according to the following equation:

$$BCK \text{ frequency} = \text{SampleRate} * \text{SlotLength} * \text{SlotNumber}$$

SampleRate: Sample rate for this digital audio interface;

SlotLength: The length of one audio slot in unit of BCK clock;

SlotNumber: How many slots supported in this audio interface. For example: 2-slot supported in I2S mode, 4-slot supported in TDM mode.

The word select and bit clock signals of the I²S input are the reference signals for the digital audio interface and Phased Locked Loop (PLL).

The input audio data can be attenuated -6dB in this module, by setting bit I2SCTRL.INPLEV. The audio source can be from left channel, right channel or the average of the left and right channel, which is controlled by I2SCTRL.CHSEL.

Table 3 Supported I2S interface parameters

Interface format(MSB first)	Data width	BCK frequency
Standard I ² S	16b 20b/24b/32b	32fs/48fs /64fs 48fs /64fs
left-justified	16b 20b/24b/32b	32fs/48fs /64fs 48fs /64fs
right-justified	16b 20b/24b/32b	32fs /48fs /64fs 48fs /64fs

The output port DATA0, can be enabled or disabled via bit I2SCFG1.I2STXEN. The unused slots can be set to Hi-z or zero, which is controlled by I2SCFG1.DOHZ.

STANDARD I²S MODE

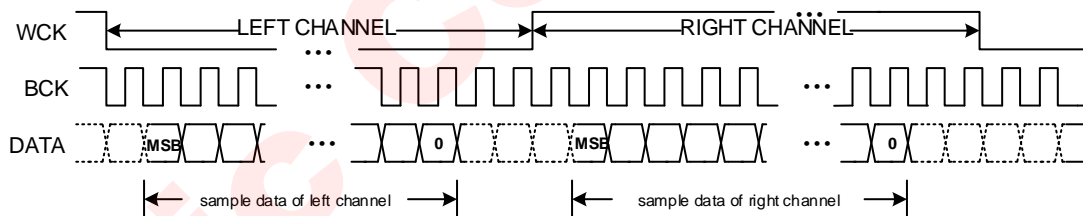
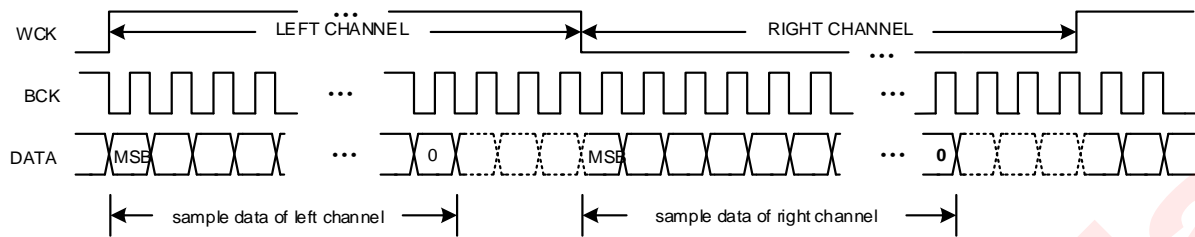
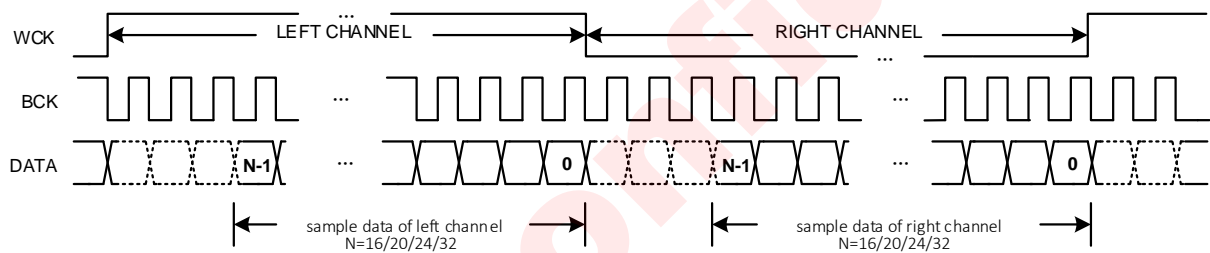

Figure 9 I²S Timing for Standard I²S Mode

- When WCK=0 indicating the left channel data, and WCK=1 indicating the right channel data.
- The MSB of the left channel is valid on the second rising edge of the bit clock after the falling edge of the word clock. Similarly the MSB of the right channel is valid on the second rising edge of the bit clock after the rising edge of the word clock.

LEFT-JUSTIFIED MODE**Figure 10 I²S Timing for Left-Justified Mode**

- When WCK=1 indicating the left channel data, and WCK=0 indicating the right channel data.
- The MSB of the left channel is valid on the first rising edge of the bit clock after the rising edge of the word clock. Similarly the MSB of the right channel is valid on the first rising edge of the bit clock after the falling edge of the word clock.

RIGHT-JUSTIFIED MODE**Figure 11 I²S Timing for Right-Justified Mode**

- When WCK is high indicating the left channel data, and WCK=0 indicating the right channel data.
- The LSB (bit 0) of the left channel is valid on the rising edge of the bit clock preceding the falling edge of the word clock. Similarly, the LSB (bit 0) of the right channel is valid on the rising edge of the bit clock preceding the rising edge of the word clock.

TDM MODE

All of the three kind of bit synchronization modes (standard, left-justified, right-justified) are also supported in TDM mode. The difference between TDM and I²S is the slot number supported. 4-slot is supported in TDM mode, while 2-slot is supported in I²S mode

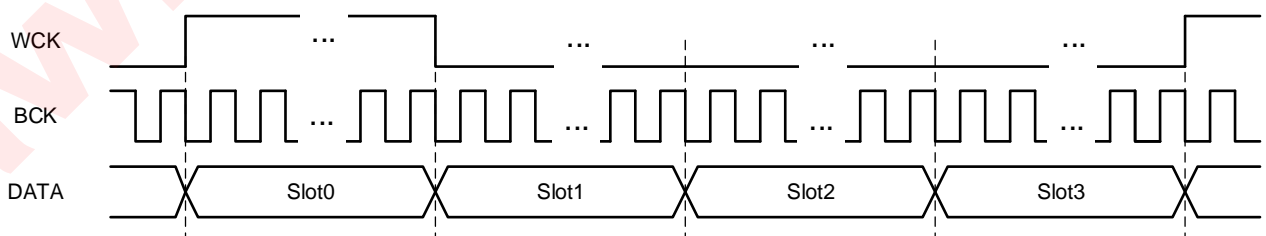
**Figure 12 TDM Timing**

Note: The high level pulse width of WCK signal can be one slot time or one period of BCK.

DIGITAL AUDIO PROCESSING

This device provides algorithm supporting for audio signal processing. The following functions are processed in this module.

- HDCC
- Hardware AGC
- Volume control
- Mute

The signal processing flow in the DAP(Digital Audio Processor) is illustrated in the following figure.

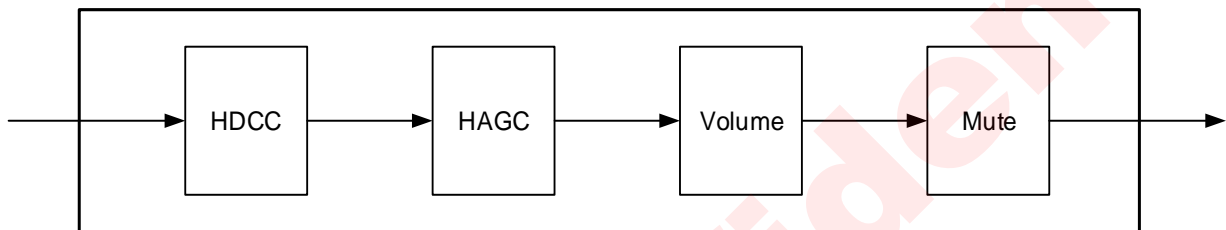

Figure 13 Block Diagram of DAP

HDCC

This module performs hardware DC canceling for the input audio stream. It blocks DC components into analog class D loop.

HAGC

In the actual audio application, system output power tends to be more than rated power of speaker, such as in the 10.25V power supply, as for 8ohms speaker, the maximum undistorted power is about 5.3W, but many speakers' rated power is about 1W, if there is no output power control, the overload signal can cause damage to the speaker. The audio power amplifier with hardware AGC can protect the speaker effectively, When the output power is not exceeds the setting threshold, the hardware AGC module will not attenuate the internal gain. Once the output power exceeds the setting threshold, the hardware AGC module will reduce the internal gain of amplifier and restricts the output power under the setting threshold.

VOLUME CONTROL

The volume control function attenuates the audio signal at the end of digital audio processing. The range of volume setting is from 0db to -96db with 0.5db/step

MUTE

This module perform mute control for the audio stream

DC-DC CONVERTER

This device using smart boost converter generates the amplifier supply rail, working in 1.6MHz. The DC-DC converter can work in different mode via `BSTCTRL2.BST_MODE`:

- **Pass-through mode:** the voltage of VDD is transparently passed to output of converter PVDD
- **Force boost mode:** the output voltage is boosted to the programmed output voltage
- **Smart boost 1 mode:** the output voltage can be switch between VDD and programmed output voltage according to the input audio level.
- **Smart boost 2 mode:** the output voltage can be dynamically adjusted according to the amplifier output's signal swing requirements in order to maximize efficiency.

Pass-through mode

The internal boost circuit is not working; the voltage of VDD is passed to PVDD directly.

Force boost mode

The boost circuit is always working and converts the voltage of VDD to the programmed output voltage. The output voltage is configured via `BSTCTRL2.VOUT_VREFSET`

Smart boost 1 mode

Smart boost 1 mode can dynamically turn off the boost according to the amplifier output's signal swing requirements in order to maximize efficiency.

Smart boost 2 mode

The boost circuits working dynamically according to the input audio level. When the level of input audio signal is below the setting threshold, the boost circuit will be deactivated. Till the level of input audio signal raised up and above the threshold, the boost circuit starts to work and boost the amplifier supply rail to the voltage fit the requirement of output signal before the audio stream arriving at amplifier power stage.

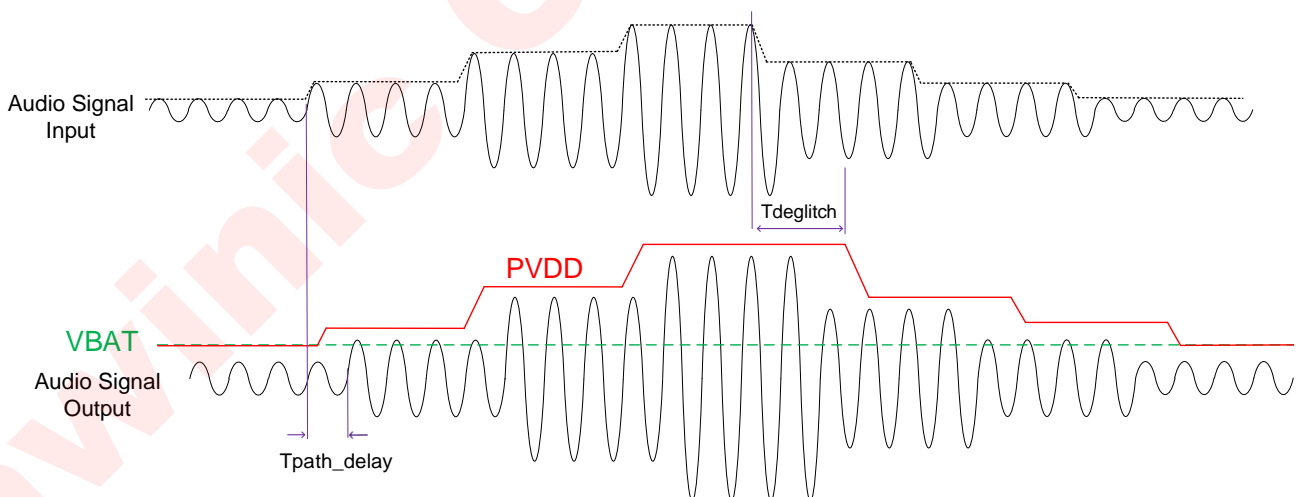

Figure 14 Boost Circuit Behavior in Smart Boost 2 Mode

PROTECTION MECHANISMS

Over Voltage Protection (OVP)

The boost circuit has integrated the over voltage protection control loop. When the output voltage PVDD is above the threshold, the boost circuits will stop working, until the voltage of PVDD going down and under the normal fixed working voltage.

Over Temperature Protection (OTP)

The device has automatic temperature protection mechanism which prevents heat damage to the chip. It is triggered when the junction temperature is larger than the preset temperature high threshold (default = 160°C). When it happens, the output stages will be disabled. When the junction temperature drops below the preset temperature low threshold (less than 130°C), the output stages will start to operate normally again

Over Current (short) Protection (OCP)

The short circuit protection function is triggered when VOP/VON is short to PVDD/GND or VOP is short to VON, the output stages will be shut down to prevent damage to itself. When the fault condition is disappeared, the output stages of device will restart.

Under Voltage Detection (UVL)

The interrupt bit SYSINT.UVLI will be set to 1 when under voltage occurs, which will be cleared by a read operation of SYSINT register. Usually the SYSINT.UVLI bit can be used to check whether an unexpected under-voltage event has taken place.

BATTERY VOLTAGE MONITORING

The device monitors the voltage on the VDD pin, which is most commonly the battery for the system. The battery voltage level is available via bits VBAT_DET in the Battery Supply Voltage register VBAT. Status bits BAT_DET can be used to calculate the battery voltage. The battery voltage level V_{BAT} is:

$$V_{BAT} = \frac{VBAT_DET}{2^{10} - 1} \times 6.025V$$

For example, if VBAT_DET = 101010011, the battery voltage level V_{BAT} is equal to 3.6V.

PVDD VOLTAGE MONITORING

The device monitors the voltage on the PVDD pin, which is most commonly the PVDD voltage level for the system. The PVDD pin voltage level is available via bits PVDD_DET in the Power Supply Voltage monitor register PVDD. Status bits PVDD_DET can be used to calculate the PVDD voltage. The PVDD voltage level V_{PVDD} is:

$$V_{PVDD} = \frac{PVDD_DET}{2^{10} - 1} \times 12.05V$$

For example, if PVDD_DET = 101010011, the PVDD voltage level V_{PVDD} is equal to 7.2V.

DIE TEMPERATURE MONITORING

The device monitors the die temperature and the result is available via bits TEMP_DET in the Temperature register TEMP. The TEMP_DET is a two's complement value. For example, if TEMP_DET = 00011001, the die temperature is 25°C.

CURRENT SENSING

The device provides speaker current sense for real time monitoring of loudspeaker behavior. The current sensing transfer function I_{SNS} is:

$$I_{SNS} = \frac{D_{OUT}}{2^{11} - 1} \times 3.667A$$

D_{OUT} : the current sense I²S output stream

VOLTAGE SENSING

The device provides speaker voltage sense for real time monitoring of loudspeaker behavior. The voltage sensing transfer function V_{SNS} is:

$$V_{SNS} = \frac{D_{OUT}}{2^{11} - 1} \times 18V$$

AMPLIFIER TRANSFER FUNCTION

The transfer function from the input to the amplifier PWM output (when no gain and attenuation is applied in digital signal domain) is:

$$V_o = AMP_NORM_V \times D_{in}$$

D_{in} : the level of input signal with a range from -1 to +1

AMP_NORM_V : the equivalent amplifier output voltage when D_{in} is 1. In receiver mode the AMP_NORM_V is 5V, in speaker mode it's 16V.

RECEIVER MODE

The device built-in Receiver mode is easy to realize the Speaker and Receiver combo applications, it saves the system cost and board space. If the receiver magnification is one times, the noise floor will be 12 μ V. Speaker and Receiver combo applications can be realized without changing any hardware.

When the device is set to receiver mode, the power supply of Class D driver stage is from VDD directly without boost.

I²C INTERFACE

This device supports the I²C serial bus and data transmission protocol in fast mode at 400 kHz. This device operates as a slave on the I²C bus. Connections to the bus are made via the open-drain I/O pins SCL and SDA. The pull-up resistor can be selected in the range of 1k~10kΩ and the typical value is 4.7kΩ. This device can support different high level (1.8V~3.3V) of this I²C interface.

DEVICE ADDRESS

The I²C device address (7-bit) can be set using the AD pin according to the following table: The AD1, AD2 pin configures the two LSB bits of the following 7-bit binary address A6-A0 of 01101xx. The permitted I²C addresses are 0x34(7-bit) through 0x37(7-bit).

Table 4 Address Selection

AD2	AD1	Address(7-bit)
0	0	0x34
0	1	0x35
1	0	0x36
1	1	0x37

DATA VALIDATION

When SCL is high level, SDA level must be constant. SDA can be changed only when SCL is low level.

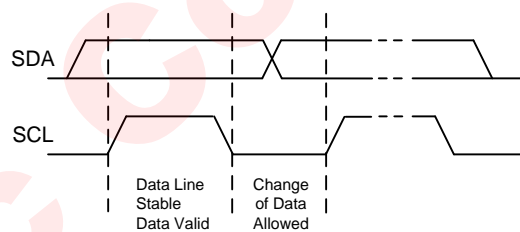
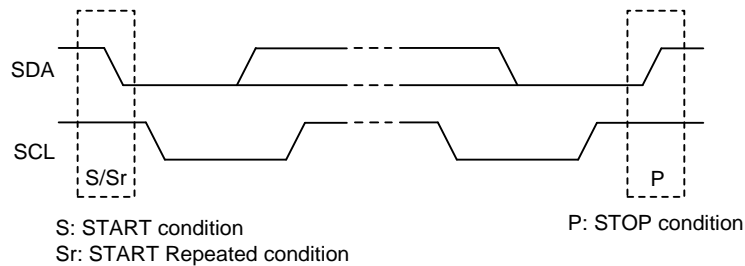

Figure 15 Data Validation Diagram

I²C START/STOP

I²C start: SDA changes from high level to low level when SCL is high level.

I²C stop: SDA changes from low level to high level when SCL is high level.

Figure 16 I²C Start/Stop Condition Timing**ACK (ACKNOWLEDGEMENT)**

ACK means the successful transfer of I²C bus data. After master sends 8bits data, SDA must be released; SDA is pulled to GND by slave device when slave acknowledges.

When master reads, slave device sends 8bit data, releases the SDA and waits for ACK from master. If ACK is send and I²C stop is not send by master, slave device sends the next data. If ACK is not send by master, slave device stops to send data and waits for I²C stop.

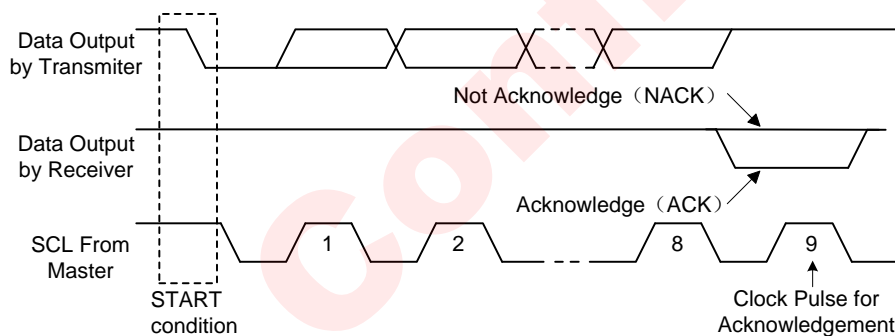
Figure 17 I²C ACK Timing**WRITE CYCLE**

One data bit is transferred during each clock pulse. Data is sampled during the high state of the serial clock (SCL). Consequently, throughout the clock's high period, the data should remain stable. Any changes on the SDA line during the high state of the SCL and in the middle of a transaction, aborts the current transaction. New data should be sent during the low SCL state. This protocol allows a single data line to transfer both command/control information and data using the synchronous serial clock.

Each data transaction is composed of a Start Condition, a number of byte transfers (set by the software) and a Stop Condition to terminate the transaction. Every byte written to the SDA bus must be 8 bits long and is transferred with the most significant bit first. After each byte, an Acknowledge signal must follow.

In a write process, the following steps should be followed:

- Master device generates START condition. The "START" signal is generated by lowering the SDA signal while the SCL signal is high.
- Master device sends slave address (7-bit) and the data direction bit ($r/w = 0$).

- c) Slave device sends acknowledge signal if the slave address is correct.
- d) Master sends control register address (8-bit)
- e) Slave sends acknowledge signal
- f) Master sends high data byte of 16-bit data to be written to the addressed register
- g) Slave sends acknowledge signal
- h) Master sends low data byte of 16-bit data to be written to the addressed register
- i) Slave sends acknowledge signal
- j) If master will send further 16-bit data bytes the control register address will be incremented by one after acknowledge signal of step g (repeat step f to g)
- k) Master generates STOP condition to indicate write cycle end

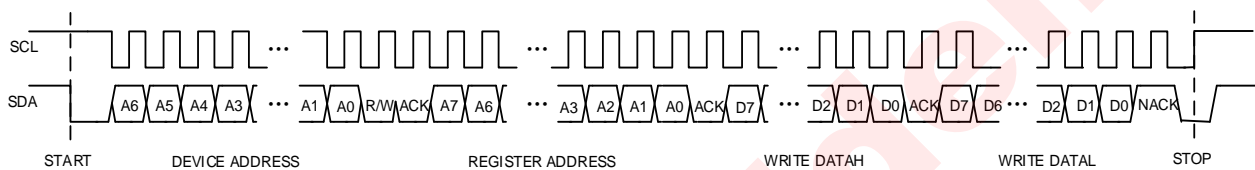

Figure 18 I²C Write Byte Cycle

READ CYCLE

In a read cycle, the following steps should be followed:

- a) Master device generates START condition
- b) Master device sends slave address (7-bit) and the data direction bit ($r/w = 0$).
- c) Slave device sends acknowledge signal if the slave address is correct.
- d) Master sends control register address (8-bit)
- e) Slave sends acknowledge signal
- f) Master generates STOP condition followed with START condition or REPEAT START condition
- g) Master device sends slave address (7-bit) and the data direction bit ($r/w = 1$).
- h) Slave device sends acknowledge signal if the slave address is correct.
- i) Slave sends read high data byte of 16-bit data from addressed register.
- j) Master sends acknowledge signal.
- k) Slave sends read low data byte of 16-bit data from addressed register.
- l) If the master device sends acknowledge signal, the slave device will increase the control register address by one, then send the next 16-bit data from the new addressed register.
- m) If the master device generates STOP condition, the read cycle is ended.

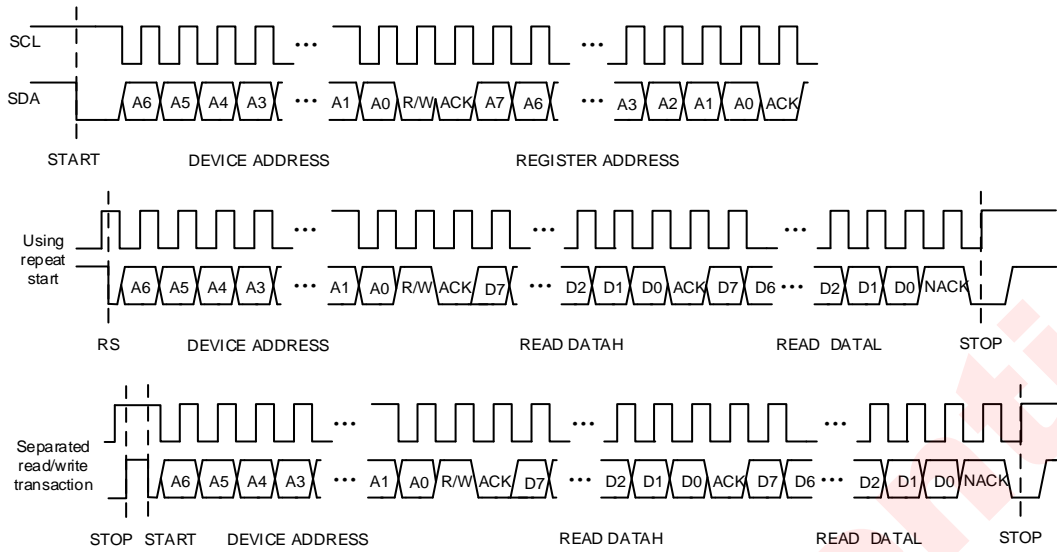

Figure 19 I²C Read Byte Cycle

REGISTER MAP

REGISTER DESCRIPTION

REGISTER LIST

ADDR	NAME	R/W	Bit15	Bit14	Bit13	Bit12	Bit11	Bit10	Bit9	Bit8	Bit7	Bit6	Bit5	Bit4	Bit3	Bit2	Bit1	Bit0	
0x00	ID	RO	IDCODE																
0x01	SYSST	RO	OVP2S	UVLS	ADPS		BSTOCS	OVPS	BSTS	SWS	CLIPS		NOCLKS	CLKS	OCDS	CLIP_PRES	OTHS	PLLS	
0x02	SYSINT	RC	OVP2I	UVLI	ADPI		BSTOCI	OVPI	BSTI	SWI	CLIP_I		NOCLKI	CLKI	OCDI	CLIP_PREI	OTHI	PLLI	
0x03	SYSINTM	RW	OVP2M	UVLM	ADPM		BSTOCM	OVPM	BSTM	SWM	CLIPM		NOCLKM	CLKM	OCDM	CLIP_PREM	OTHM	PLLM	
0x04	SYSCTRL	RW		SPK_GAIN			RCV_GAIN		INTMODE	INTN	RCV_MODE	I2SEN	WSINV	BCKINV	IPLL		AMPPD	PWDN	
0x05	SYSCTRL2	RW									RMSE	HAGCE	HDCCE	HMUTE	BST_IPEAK				
0x06	I2SCTRL	RW				INPLEV	I2SRXEN	CHSEL		I2SMD		I2SFS		I2SBCK		I2SSR			
0x07	I2SCFG1	RW				I2S_TX_SLOTVLD		I2S_RX_SLOTVLD				CFSEL		DRVSTREN	DOHZ	FSYNC_TYPE	SLOT_NUM	I2SCHS	I2STXEN
0x09	HAGCCFG1	RW	RVTH								AVTH								
0x0a	HAGCCFG2	RW	ATTH																
0x0b	HAGCCFG3	RW	RTTH																
0x0c	HAGCCFG4	RW	VOL								HOLDTH								
0x10	HAGCST	RO	BSTVOUT_ST																
0x12	VBAT	RO	VBAT_DET																
0x13	TEMP	RO	TEMP_DET																

ADDR	NAME	R/W	Bit15	Bit14	Bit13	Bit12	Bit11	Bit10	Bit9	Bit8	Bit7	Bit6	Bit5	Bit4	Bit3	Bit2	Bit1	Bit0	
0x14	PVDD	RO							PVDD_DET										
0x60	BSTCTRL1	RW				BST_RTH								BST_ATH					
0x61	BSTCTRL2	RW	VOUT_CTMD	BST_MODE					BST_TDEG		VOUT_VFBSET			VOUT_VREFSET					
0x78	EFRH	RO							EF_VSN_GESLP										
0x7a	EFRM1	RO							EF_ISN_GESLP										

DETAILED REGISTER DESCRIPTION

ID: (Address 00h)				
Bit	Symbol	R/W	Description	Default
15:0	IDCODE	RO	Chip ID (1852h) will be returned after read. All configuration registers will be reset to default value after 0x55aa is written	0x1852

SYSST: (Address 01h)				
Bit	Symbol	R/W	Description	Default
15	OVP2S	RO	Boost OVP2 status indicator	0
14	UVLS	RO	VDD under voltage indicator 0: VDD > 2.8V 1: VDD < 2.8V	0
13	ADPS	RO	Boost Adaptive status. 0: transparent 1: boost	0
12	Reserved	RO	Not used	0
11	BSTOCS	RO	Boost over current indicator	0
10	OVPS	RO	Boost OVP status indicator	0
9	BSTS	RO	Boost start up finished. 0: not finished 1: finished	0
8	SWS	RO	Ampifier switching status. 0: not switching 1: switching	0
7	CLIPS	RO	Ampifier clipping status. 0: not clipping 1: clipping	0
6	Reserved	RO	Not used	0
5	NOCLKS	RO	The reference clock of PLL is not available	0
4	CLKS	RO	All internal clock are stable CLKS = PLLS & ~IDP	0
3	OCDS	RO	Over current status in amplifier	0
2	CLIP_PRE	RO	Ampifier clipping pre status.	0
1	OTHS	RO	Die Temperature is higher than 160degrees	0
0	PLLS	RO	PLL locked status. 0: unlocked 1: locked	0

SYSINT: (Address 02h)				
Bit	Symbol	R/W	Description	Default
15	OVP2I	RC	Interrupt indicator for OVP2S.	0
14	UVLI	RC	Interrupt indicator for Power On and UVLS	0
13	ADPI	RC	Interrupt indicator for ADPS	0
12	Reserved	RC	Not used	0
11	BSTOCI	RC	Interrupt indicator for BSTOCS.	0
10	OVPI	RC	Interrupt indicator for OVPS.	0
9	BSTI	RC	Interrupt indicator for BSTS.	0
8	SWI	RC	Interrupt indicator for SWS.	0
7	CLIP	RC	Interrupt indicator for CLIPS.	0

6	Reserved	RC	Not used	0
5	NOCLKI	RC	Interrupt indicator for NOCLKS.	0
4	CLKI	RC	Interrupt indicator for CLKI.	0
3	OCDI	RC	Interrupt indicator for OCDS	0
2	CLIP_PREI	RC	Interrupt indicator for CLIP_PRES	0
1	OTHI	RC	Interrupt indicator for OTHS.	0
0	PLLI	RC	Interrupt indicator for PLLS.	0

SYSINTM: (Address 03h)

Bit	Symbol	R/W	Description	Default
15	OVP2M	RW	Interrupt mask for OVP2I	1
14	UVLM	RW	Interrupt mask for UVLI.	1
13	ADPM	RW	Interrupt mask for ADPI	1
12	Reserved	RW	Not used	0
11	BSTOCM	RW	Interrupt mask for BSTOCI.	1
10	OVRPM	RW	Interrupt mask for OVPI	1
9	BSTM	RW	Interrupt mask for BSTI.	1
8	SWM	RW	Interrupt indicator for SWI.	1
7	CLIPM	RW	Interrupt indicator for CLIPI.	1
6	Reserved	RW	Not used	0
5	NOCLKM	RW	Interrupt mask for NOCLKI.	1
4	CLKM	RW	Interrupt mask for CLKI.	1
3	OCDM	RW	Interrupt mask for OCDI.	1
2	CLIP_PREM	RW	Interrupt mask for CLIP_PREI.	1
1	OTHM	RW	Interrupt mask for OTHI.	1
0	PLLM	RW	Interrupt mask for PLLI.	1

SYSCTRL: (Address 04h)

Bit	Symbol	R/W	Description	Default
15	Reserved	RW	Not used	0
14:12	SPK_GAIN	RW	Configuration for gain in Speaker Mode 000: AV=7 001: AV=8 010: AV=10 011: AV=14 100: AV=16 101: AV=20 Others: Reserved	0x4
11:10	RCV_GAIN	RW	Configuration for gain in Receiver Mode 00: AV=4.5 01: AV=5 10: AV=5.5 11: AV=7.5	0
9	INTMODE	RW	Interrupt pad INTN output mode selection 0: Open-drain 1: Push&Pull	0
8	INTN	RW	Interrupt pad INTN pin-source selection 0: SYSINT 1: SYSST	0

7	RCV_MODE	RW	Receiver mode enable, active "1". 0: Speaker mode, VCOM=1/3*PVDD 1: Receiver mode, VCOM=1/2*PVDD	0
6	I2SEN	RW	Disable/Enable whole I2S interface module 0: disable 1: enable	0
5	WSINV	RW	I2S Left/Right channel switch 0: No switch 1: Left/Right switch	0
4	BCKINV	RW	I2S bit clock invert control 0: not invert 1: inverted	0
3	IPLL	RW	PLL reference clock selection 0: bit clock 1: word selection signal	0
2	Reserved	RW	Not used	0
1	AMPPD	RW	Amplifier power down control bit, PowerDown until system configuration finished 0: normal working 1: power down	1
0	PWDN	RW	System power down control bit 0: System normal working 1: All circuits will enter power down mode	1

SYSCTRL2: (Address 05h)				
Bit	Symbol	R/W	Description	Default
15:8	Reserved	RW	Not used	0
7	RMSE	RW	Enable of RMS HAGC 0:disable 1:enable	0
6	HAGCE	RW	Disable/Enable Peak AGC 0:disable 1:enable	0
5	HDCCE	RW	Enable/Disable Hardware DC Canceling module 0: disable 1: enable	1
4	HMUTE	RW	Enable/Disable Hardware mute module 0: disable 1: enable	1

3:0	BST_IPEAK	RW	Boost peak current limiter threshold 0000: 1.5A 0001: 1.75A 0010: 2.0A 0011: 2.25A 0100: 2.5A 0101: 2.75A 0110: 3.0A 0111: 3.25A 1000: 3.5A 1001: 3.75A 1010: 4A 1011: 4.25A Others: Reserved	8
-----	-----------	----	--	---

I2SCTRL: (Address 06h)				
Bit	Symbol	R/W	Description	Default
15:14	Reserved	RW	Not used	0
13	INPLEV	RW	Input level selection bit, when it is set to 1, all input signal will be attenuated at first 0: not attenuated 1: attenuated by -6dB	0
12	I2SRXEN	RW	Disable/Enable I2S receiver module 0: disable 1: enable	1
11:10	CHSEL	RW	Left/right channel selection for I2S input 00: reserved 01: left 10: right 11: mono, (L+R)/2	1
9:8	I2SMD	RW	I2S interface mode 00: Philip standard I2S (default) 01: MSB justified 10: LSB justified 11: Reserved	0
7:6	I2SFS	RW	I2S LSB justified mode data width selection 00: 16 bits 01: 20 bits 10: 24 bits 11: 32 bits	3
5:4	I2SBCK	RW	I2S BCK mode 00: 32*fs(16*2) 01: 48*fs(24*2) 10: 64*fs(32*2) 11: Reserved	2

3:0	I2SSR	RW	I2S interface sample rate configuration 0000: 8 kHz 0001: 11.025kHz 0010: 12 kHz 0011: 16 kHz 0100: 22.05kHz 0101: 24 kHz 0110: 32 kHz 0111: 44.1 kHz 1000: 48 kHz 1001: 96 KHz 1010: 192KHz Others: Reserved	8
-----	-------	----	---	---

I2SCFG1: (Address 07h)				
Bit	Symbol	R/W	Description	Default
15:14	Reserved	RW	Not used	0
13:12	I2S_TX_SLOTVLD	RW	TX slot selection, data will be sent to one of the four slots in TDM mode. 00: Slot 0 01: Slot 1 10: Slot 2 11: Slot 3	0
11:8	I2S_RX_SLOTVLD	RW	RX slots selection, two slots will be chosen as active slots in TDM mode. Valid settings are as follows 0011: Slots 0 and 1 0101: Slots 0 and 2 1001: Slots 0 and 3 0110: Slots 1 and 2 1010: Slots 1 and 3 1100: Slots 2 and 3 Others: Reserved	3
7:6	CFSEL	RW	I2S legacy path output data selection 00: HAGC data 01: IV sense data Others: Reserved	0
5	DRVSTREN	RW	I2S_DATAO PAD driving strength setting 0: 2mA 1: 8mA	1
4	DOHZ	RW	Unused channel data control 0: All Channels available 1: Hi-Z	1
3	FSYNC_TYPE	RW	Audio Frame synchronization signal (WCK) pulse width configuration 0: one slot width 1: one BCK clock cycle	0
2	SLOT_NUM	RW	Slot number selection, the 2-slot mode is compatible with I2S, and 4-slot mode is for TDM mode (max 4 slots support). 0: 2 slots 1: 4 slots	0
1	I2SCHS	RW	I2S Tx Channel output selection 0: Left channel 1: Right channel	0

0	I2STXEN	RW	Disable/Enable I2S transmitter module 0: disable 1: enable	0
---	---------	----	--	---

HAGCCFG1: (Address 09h)				
Bit	Symbol	R/W	Description	Default
15:8	RVTH	RW	Release Amplitude threshold, in percent of signal full scale	0x39
7:0	AVTH	RW	Attack Amplitude threshold, in percent of signal full scale RMSE = 0: $PO = ((i/256 * Gain)^2) / 8 / 2$ RMSE = 1: $PO = (i/256) * (Gain^2) / 8$	0x40

HAGCCFG2: (Address 0ah)				
Bit	Symbol	R/W	Description	Default
15:0	ATTH	RW	Attack time threshold in unit of 20.8 μ s 0: reserved n: gain decreased 0.5db per n*20.8us	0x0030

HAGCCFG3: (Address 0bh)				
Bit	Symbol	R/W	Description	Default
15:0	RTTH	RW	Release time threshold in unit of 20.8 μ s 0: reserved n: gain decreased 0.5db per n*20.8 μ s	0x01E0

HAGCCFG4: (Address 0ch)				
Bit	Symbol	R/W	Description	Default
15:8	VOL	RW	Volume control, from 0 to -96dB [3:0] : in unit of -0.5dB [7:4] : in unit of -6dB	0
7:0	HOLDTH	RW	Attack time threshold in unit of about 1.33ms 0: reserved n: attack counter holding at least n*1.33ms	0x64

HAGCST: (Address 10h)				
Bit	Symbol	R/W	Description	Default
15:6	Reserved	RO	Not used	0
5:0	BSTVOUT_ST	RO	Actual setting of boost output voltage (125mV/Step) 000000: 3.125V 000001: 3.25V 000010: 3.375V 000011: 3.5V 000100: 3.625V 000101: 3.75V 111111: 11V	0

VBAT: (Address 12h)				
Bit	Symbol	R/W	Description	Default
15:10	Reserved	RO	Not used	0
9:0	VBAT_DET	RO	Detected Voltage of battery, and the fullrange is 6.025V $V_BATS = (VBAT) / 1023 * 6.025$	0x263

TEMP: (Address 13h)				
Bit	Symbol	R/W	Description	Default
15:10	Reserved	RO	Not used	0
9:0	TEMP_DET	RO	Detected Die Temperature(Two's Complement), typical values are as follows. 0x3D8 : -40degree 0x00 : 0 degree 0x01 : 1 degree 0x19 : 25 degree 0x37 : 55 degree Please convert it to decimal number please.	0x019

PVDD: (Address 14h)				
Bit	Symbol	R/W	Description	Default
15:10	Reserved	RO	Not used	0
9:0	PVDD_DET	RO	Detected Voltage of PVDD, and the fullrange is 12.05V $PVDD=(PVDD_DET)/1023 \times 12.05$	0x263

BSTCTRL1: (Address 60h)				
Bit	Symbol	R/W	Description	Default
15:14	Reserved	RW	Not used	0
13:8	BST_RTH	RW	Smart boost release threshold setting, When signal is below the threshold, the voltage of VBST will not be raised up higher than VDD in smart boost mode Release threshold = $BST_RTH * 1/64$ FullScale	4
7:6	Reserved	RW	Not used	0
5:0	BST_ATH	RW	Smart boost attack threshold setting. When signal is above over the threshold, the voltage of VBST will be raised up higher than VDD in smart boost mode Attack threshold = $BST_ATH * 1/64$ FullScale	2

BSTCTRL2: (Address 61h)				
Bit	Symbol	R/W	Description	Default
15	VOUT_CTMD	RW	BOOST output voltage control mode selection 0: PVDD controlled by VREF (125mV/step) 1: PVDD controlled by VFB (4 levels)	0
14:12	BST_MODE	RW	BOOST mode selection, Initialize to 6 . 000: Transparent Mode 001: Force Boost Mode 011: Test Boost Mode 101: Class G Mode Others: Class H Mode	0x6
11	Reserved	RW	Not used	0

10:8	BST_TDEG	RW	Smart ClassG Boost small signal level detection deglitch time 000: 0.33 ms 001: 1.40 ms 010: 5.60 ms 011: 21.30 ms 100: 44 ms 101: 88 ms 110: 352 ms 111: 1.4 s	0x6
7:6	VOUT_VFBSET	RW	BOOST output voltage control bits controlled by VFB 00: 8.5V 01: 9.5V 10: 10.5V 11: 10.5V	1
5:0	VOUT_VREFSET	RW	BOOST max output voltage control bits (125mV/Step) 000000: 3.125V 000001: 3.25V 000010: 3.375V 000011: 3.5V 000100: 3.625V 000101: 3.75V 111111: 11V	0x33

EFRH: (Address 78h)

Bit	Symbol	R/W	Description	Default
15:10	Reserved	RO	-	0
9:0	EF_VSN_GESLP	RO	Data read from eFuse, for trimming the Vsense gain error (slope)	0

EFRM1: (Address 7ah)

Bit	Symbol	R/W	Description	Default
15:10	Reserved	RO	-	0
9:0	EF_ISN_GESLP	RO	Data read from eFuse, for trimming the I-sense gain error (slope)	0

APPLICATION INFORMATION

EXTERNAL COMPONENTS

BOOST INDUCTOR SELECTION

Selecting inductor needs to consider Inductance, size, magnetic shielding, saturation current and temperature current.

a) Inductance

Inductance value is limited by the boost converter's internal loop compensation. In order to ensure phase margin sufficient under all operating conditions, recommended 1μH inductor.

b) Size

For a certain value of inductor, the smaller the size, the greater the parasitic series resistance of the inductor DCR, the higher the loss, corresponds to the lower efficiency.

c) Magnetic shielding

Magnetic shielding can effectively prevent the inductance of the electromagnetic radiation interference. It is much better to choose inductance with magnetic shielding in the application of EMI sensitive environment.

d) Saturation current and temperature rise of current

Inductor saturation current and temperature rise current value are important basis for selecting the inductor. As the inductor current increases, on the one hand, since the magnetic core begins to saturate, inductance value will decline; on the other hand, the inductor's parasitic resistance inductance and magnetic core loss can lead to temperature rise. In general, the current value is defined as the saturation current I_{SAT} when the inductance value drops to 70%; the current value is defined as temperature rise current I_{RMS} when inductance temperature rise 40°C.

For particular applications, need to calculate the maximum I_{L_PEAK} and I_{L_RMS} , which is a basis of selecting the inductor. When $V_{DD} = 4.2V$, $P_{VDD}=9.5V$, $R_L = 8\Omega$, amplifier $R_{DS(on)} = 300m\Omega$, when THD = 1% (the maximum power without distortion), the output power is calculated as follows:

$$P_{out} = \frac{\left(V_{out} \times \frac{R_L}{R_L + R_{DS(on)}}\right)^2}{2 \times R_L} = \frac{\left(9.5 \times \frac{8}{8 + 0.3}\right)^2}{2 \times 8} = 5.24W$$

In such a large output power, the overall efficiency of the power amplifier is typically 70%, in order to calculate the maximum average current $I_{MAX_AVG_VDD}$ and maximum peak current $I_{MAX_PEAK_VDD}$ drawn from VDD:

$$I_{MAX_AVG_VDD} = \frac{P_{out}}{V_{in} \times \eta} = \frac{5.24}{4.2 \times 0.7} = 1.78A$$

$$I_{MAX_PEAK_VDD} = 2 \times I_{MAX_AVG_VDD} = 2 \times 1.78A = 3.6A$$

If inductor DCR is 50mΩ, the inductor power loss at this time is:

$$P_{DCR_LOSS} = 1.5 \times I_{MAX_AVG_VDD}^2 \times DCR = 1.5 \times 1.78^2 \times 0.05W = 240mW$$

Wherein the coefficient 1.5 is the square of the ratio of the sine wave current RMS value and average value (there is no consideration of the impact of the inductor ripple, the actual DCR loss will be even greater). If the loss which is resulting from DCR is less than 1% at maximum efficiency ($P_{OUT} = 2.5W$, $\eta = 80\%$), then:

$$I_{AVG_VDD} = \frac{P_{out}}{V_{in} \times \eta} = \frac{2.5}{4.2 \times 0.8} = 0.75A$$

$$DCR = \frac{P_{DCR_LOSS}}{1.5 \times I_{MAX_AVG_VDD}^2} \leq 1\% \times \frac{P_{out}}{1.5 \times I_{AVG_VDD}^2 \times \eta} = \frac{0.01 \times 2.5}{1.5 \times 0.75^2 \times 0.8} \Omega = 37m\Omega$$

According to the working principle of the Boost, we can calculate the size of the inductor current ripple ΔI_L :

$$\Delta I_L = \frac{V_{in} \times (V_{out} - V_{in})}{V_{out} \times f \times L} = \frac{4.2 \times (9.5 - 4.2)}{9.5 \times 1.6 \times 10^6 \times 1 \times 10^{-6}} = 1.46A$$

Thus, the maximum peak inductor current I_{L_PEAK} and maximum effective inductor current I_{L_RMS} is:

$$I_{L_PEAK} = I_{MAX_PEAK_VDD} + \frac{\Delta I_L}{2} = 3.6 + \frac{1.46}{2} A = 4.33A$$

$$I_{L_RMS} = \sqrt{I_{MAX_PEAK_VDD}^2 + \frac{\Delta I_L^2}{12}} = \sqrt{3.6^2 + \frac{1.46^2}{12}} A = 3.62A$$

From the above calculation results:

- 1) For typical DCR about 50m Ω inductance, the efficiency loss caused by around 1.5%;
- 2) In practice, the maximum output power of the amplifier is likely to reach 5.6W in an instant, so the selected inductor saturation current I_{SAT} requires more than the maximum inductor peak current I_{L_PEAK} ;
- 3) In some cases, if the I_{L_PEAK} calculated according to the above method is greater than the set of input inductor current limit value I_{PEAK} , shows the power amplifier is restricted by inductance input current limit, the actual maximum output power is less than the calculated value, the measured value shall prevail, and I_{SAT} need greater than the set current limiting value I_{PEAK} , and cannot be less than 3.5A;
- 4) Take PVDD = 9.5V for example, under different conditions, the typical method of selecting I_{SAT} in the following table:

V _{DD} (V)	PVDD (V)	R _L (Ω)	I _{PEAK} (A)	Efficiency(η) (%)	P _O (W)	I _{L_PEAK} (A)	Inductor saturation current I _{SAT} minimum value (A)
4.2	9.5	8	4.25	74	5.2	4.33	4.2
4.2	9.5	6	4.25	69	5.4	4.5	4.2

- 5) As the result of the action of AGC, amplifier will not work long hours at maximum power without distortion, the actual average inductor current is far less than the maximum inductor current effective I_{L_RMS} , so when selecting the inductor, the inductor temperature rise current is not usually a limiting factor;
- 6) Inductor Selection example: the inductor package size is 252012, inductance value is 1 μ H, DCR Typical value is 48m Ω , the typical saturation current I_{SAT} is 4.2A, the typical temperature rise current I_{RMS} is 3.4A, suitable for VDD=3.6V, PVDD=9.5V, speaker impedance R_L=8 Ω , inductor input current limit I_{PEAK}= 4.25A. If you choose I_{SAT} or I_{RMS} of the inductance is too small, it is possible to cause the chip don't work properly, or the temperature of the inductance is too high.

Inductance value	size	DCR (Ω)	I _{SAT} (A)	I _{RMS} (A)
1 μ H	2.5x2.0x1.2mm	0.054	4.2	3.4

BOOST CAPACITOR SELECTION

Boost output capacitor is usually within the range $0.1\mu\text{F}\sim 47\mu\text{F}$. It needs to use Class II type (EIA) multilayer ceramic capacitors (MLCC). Its internal dielectric is ferroelectric material (typically BaTiO_3), a high the dielectric constant in order to achieve smaller size, but at the same Class II type (EIA) multilayer ceramic capacitors has poor temperature stability and voltage stability as compared to the Class I type (EIA) capacitance. Capacitor is selected based on the requirements of temperature stability and voltage stability, considering the capacitance material, capacitor voltage, and capacitor size and capacitance values.

A) temperature stability

Class II capacitance have different temperature stability in different materials, usually choose X5R type in order to ensure enough temperature stability, and X7R type capacitance has better properties, the price is relatively more expensive; X5R capacitance change within $\pm 15\%$ in temperature range of 55°C to 85°C , X7R capacitance change within $\pm 15\%$ in temperature range of $-55^\circ\text{C}\sim 125^\circ\text{C}$. The Boost output capacitance of DEVICE recommends X5R ceramic capacitors.

B) Voltage Stability

Class II type capacitor has poor voltage stability Capacitance values falling fast along with the DC bias voltage applied across the capacitor increasing. The rate of decline is related to capacitance material, capacitors rated voltage, capacitance volume. Take TDK C series X5R for example, its pressure voltage value is 16V or 25V; the package size is 0805, 1206 or 0603, the capacitance value is $10\mu\text{F}$. The capacitor's voltage stability of different types of capacitor is as shown below:

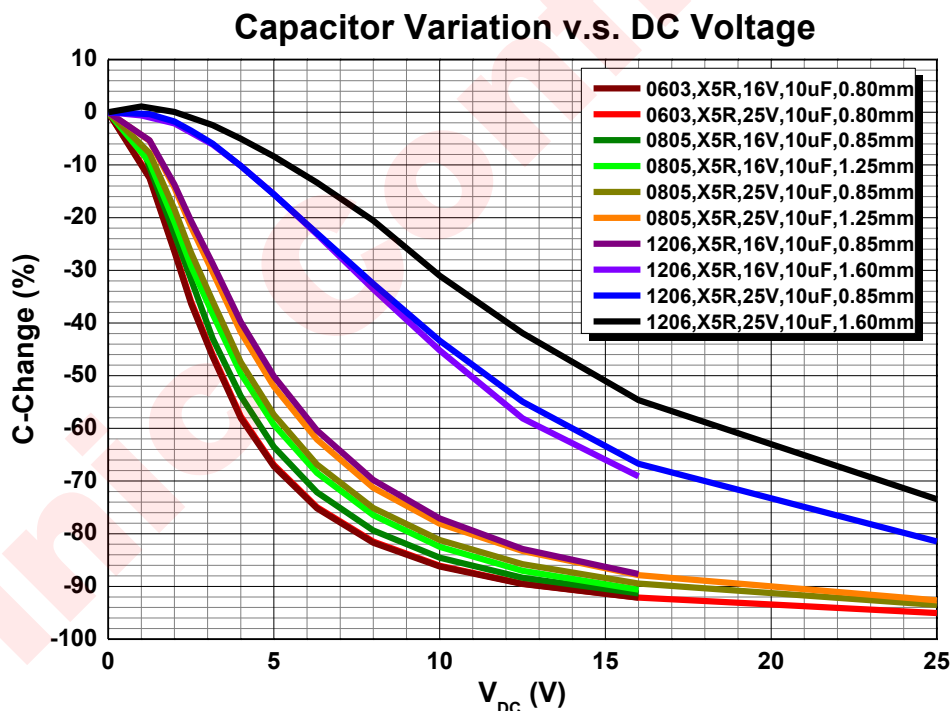

Figure 20 Different types of capacitive voltage stability

It can be found that the rate of capacitance capacity value descent becomes slow along with "large capacitor size, capacitance pressure voltage rise". The larger the package size, the better voltage stability. The higher the height, the better voltage stability with the same length and width of the capacitance. Voltage stability of smaller package size (0603) capacitor change affected by the pressure value is very small.

In typical applications, it is necessary to ensure the residual capacitance should $\geq 4\mu\text{F}$ when $\text{PVDD}=10.25\text{V}$.

Take the following capacitances as the Boost of the output capacitor for example:

value	material	size (mm ³)	rated voltage (V)	quantity	value @10.25V
10 μ F	X5R	1.60×0.80×0.80 (0603)	16	3	4.5 μ F
10 μ F	X5R	2.00×1.25×1.25 (0805)	25	2	4.2 μ F

As for the different manufacturers' capacitors, it's important to determine the type and quantity of the capacitors through the capacitor voltage stability data provided by the manufacturer.

SUPPLY DECOUPLING CAPACITOR

The device is a high-performance audio amplifier that requires adequate power supply decoupling. Place a low equivalent-series-resistance (ESR) ceramic capacitor, typically 0.1 μ F. This choice of capacitor and placement helps with higher frequency transients, spikes, or digital hash on the line. Additionally, placing this decoupling capacitor close to the DEVICE is important, as any parasitic resistance or inductance between the device and the capacitor causes efficiency loss. In addition to the 0.1 μ F ceramic capacitor, place a 10 μ F capacitor on the VBAT supply trace. This larger capacitor acts as a charge reservoir, providing energy faster than the board supply, thus helping to prevent any droop in the supply voltage.

PACKAGE DESCRIPTION

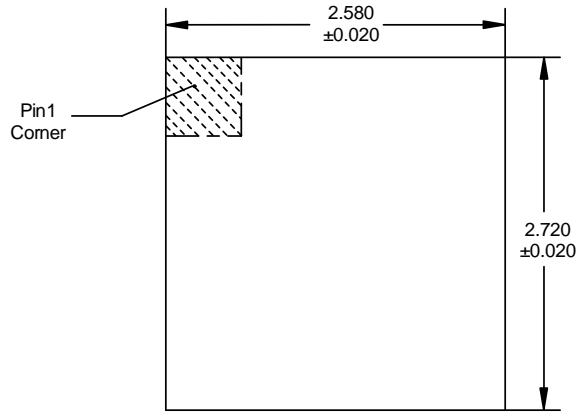

Top View

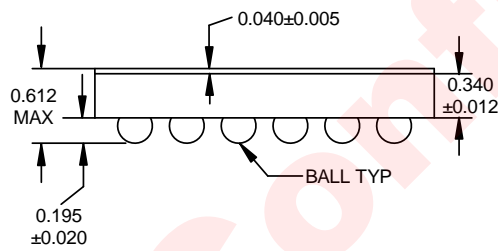

Side View

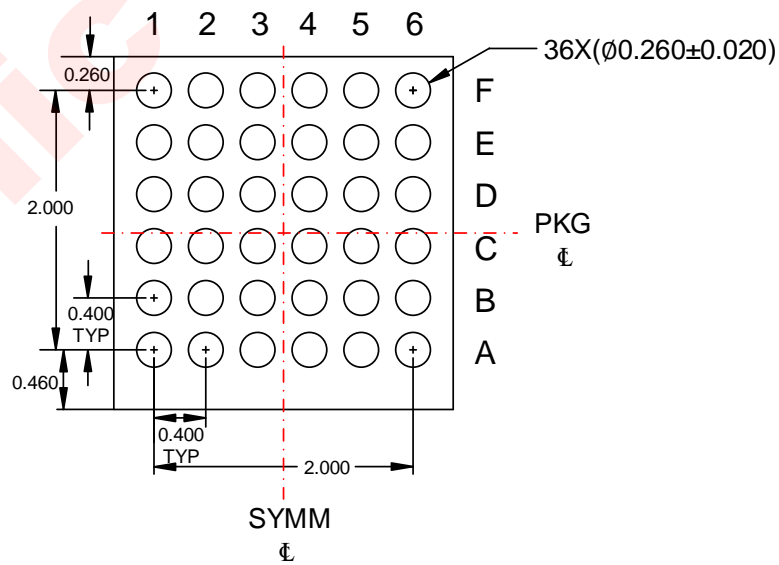

Bottom View

Unit : mm

LAND PATTERN DATA

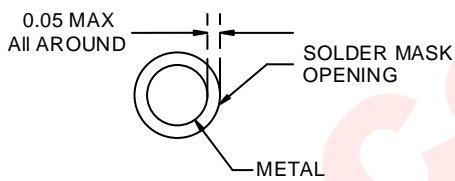
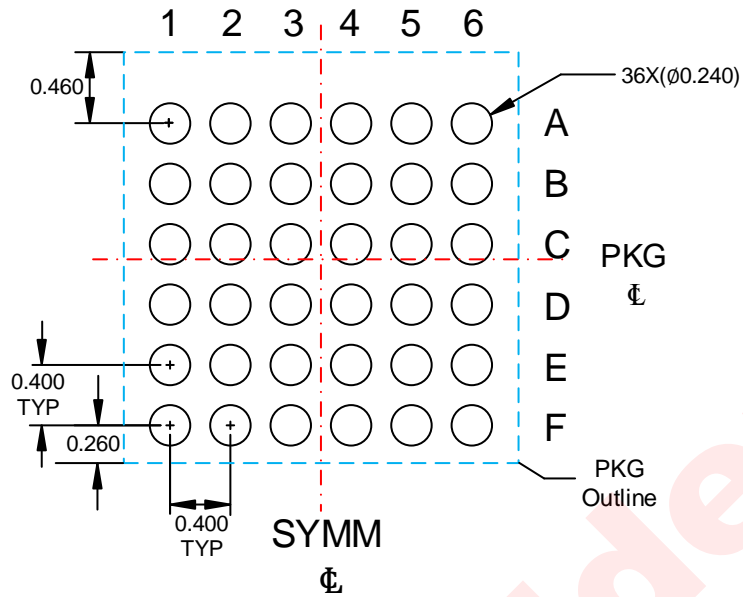

NON-SOLDER MASK DEFINED

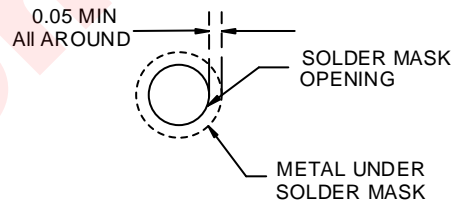

SOLDER MASK DEFINED

Unit: mm

TAPE AND REEL INFORMATION

REEL DIMENSIONS

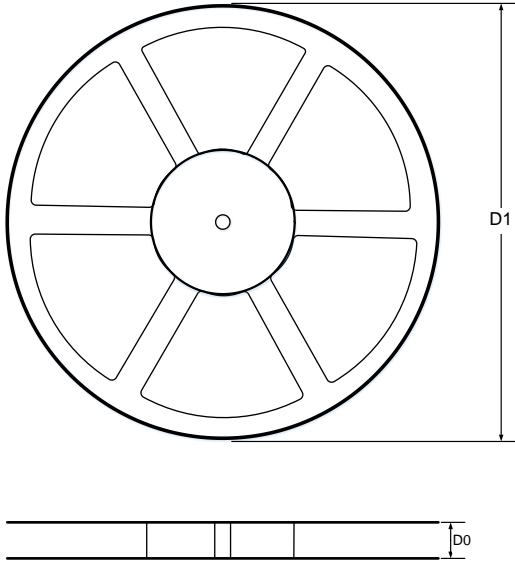

TAPE DIMENSIONS

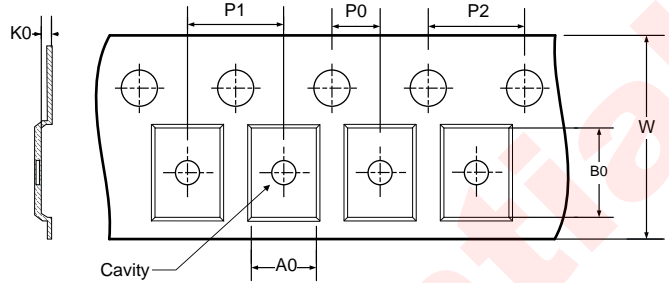

- A0: Dimension designed to accommodate the component width
- B0: Dimension designed to accommodate the component length
- K0: Dimension designed to accommodate the component thickness
- W: Overall width of the carrier tape
- P0: Pitch between successive cavity centers and sprocket hole
- P1: Pitch between successive cavity centers
- P2: Pitch between sprocket hole
- D1: Reel Diameter
- D0: Reel Width

QUADRANT ASSIGNMENTS FOR PIN 1 ORIENTATION IN TAPE

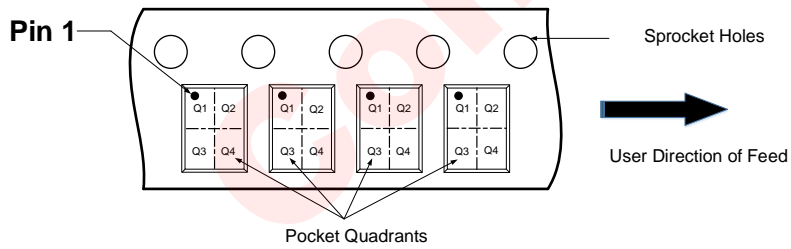

DIMENSIONS AND PIN1 ORIENTATION

D1 (mm)	D0 (mm)	A0 (mm)	B0 (mm)	K0 (mm)	P0 (mm)	P1 (mm)	P2 (mm)	W (mm)	Pin1 Quadrant
330.00	12.40	2.72	2.87	0.70	2	8	4	12	Q1

All dimensions are nominal

REVISION HISTORY

Version	Date	Change Record
V1.0	July. 2019	Officially Released

awinic Confidential

DISCLAIMER

Information in this document is believed to be accurate and reliable. However, Shanghai AWINIC Technology Co., Ltd (AWINIC Technology) does not give any representations or warranties, expressed or implied, as to the accuracy or completeness of such information and shall have no liability for the consequences of use of such information.

AWINIC Technology reserves the right to make changes to information published in this document, including without limitation specifications and product descriptions, at any time and without notice. Customers shall obtain the latest relevant information before placing orders and shall verify that such information is current and complete. This document supersedes and replaces all information supplied prior to the publication hereof.

AWINIC Technology products are not designed, authorized or warranted to be suitable for use in medical, military, aircraft, space or life support equipment, nor in applications where failure or malfunction of an AWINIC Technology product can reasonably be expected to result in personal injury, death or severe property or environmental damage. AWINIC Technology accepts no liability for inclusion and/or use of AWINIC Technology products in such equipment or applications and therefore such inclusion and/or use is at the customer's own risk.

Applications that are described herein for any of these products are for illustrative purposes only. AWINIC Technology makes no representation or warranty that such applications will be suitable for the specified use without further testing or modification.

All products are sold subject to the general terms and conditions of commercial sale supplied at the time of order acknowledgement.

Nothing in this document may be interpreted or construed as an offer to sell products that is open for acceptance or the grant, conveyance or implication of any license under any copyrights, patents or other industrial or intellectual property rights.

Reproduction of AWINIC information in AWINIC data books or data sheets is permissible only if reproduction is without alteration and is accompanied by all associated warranties, conditions, limitations, and notices. AWINIC is not responsible or liable for such altered documentation. Information of third parties may be subject to additional restrictions.

Resale of AWINIC components or services with statements different from or beyond the parameters stated by AWINIC for that component or service voids all express and any implied warranties for the associated AWINIC component or service and is an unfair and deceptive business practice. AWINIC is not responsible or liable for any such statements.

单击下面可查看定价，库存，交付和生命周期等信息

[>>AWINIC\(艾为\)](#)