

16V 500mA Low Consumption Linear Regulator

DESCRIPTION

BL8075 series is a group of positive voltage output, low power consumption, low dropout voltage regulator. It can provide 300mA output current when input / output voltage differential drops to 600mV ($V_{out}=3.3V$), and it also provides foldback short-circuit protection, thermal protection and output current limit function. The very low power consumption of BL8075 ($I_q=10\mu A$) can greatly improve natural life of batteries.

BL8075 can provide output value in the range of 1.2V~5.0V in 0.1V steps. It also can customize on command.

BL8075 includes high accuracy voltage reference, error amplifier, current limit circuit and output driver module.

BL8075 has well load transient response and good temperature characteristic, And it uses trimming technique to guarantee output voltage accuracy within $\pm 2\%$.

TYPICAL APPLICATION

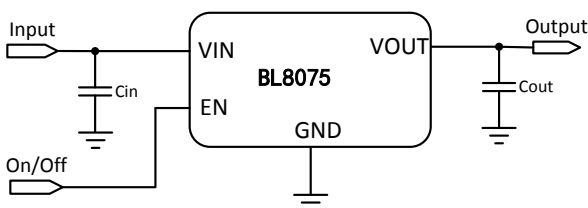

NOTE: Input capacitor ($C_{in}=1\mu F$) and Output capacitor ($C_{out}=1\mu F$) are recommended in all application circuit. Ceramic capacitor is recommended.

FEATURES

- Low Power Consumption: 10 μA (Typ.)
- Maximum Output Current: 500mA
- Small Dropout Voltage
600mV@300mA ($V_{out}=3.3V$)
1.2V@500mA ($V_{out}=3.3V$)
- Input Voltage Range: 3V~16V
- Output Voltage Range: 1.2V~5.0V (customized on command in 0.1V steps)
- Highly Accurate: $\pm 2\%$ ($\pm 1\%$ customized)
- Output Current Limit: 650mA

APPLICATIONS

- Battery Powered equipment
- Power Management of MP3、PDA、DSC、Mouse、PS2 Games
- Reference Voltage Source Regulation after Switching Power

ELECTRICAL CHARACTERISTICS

Load Regulation

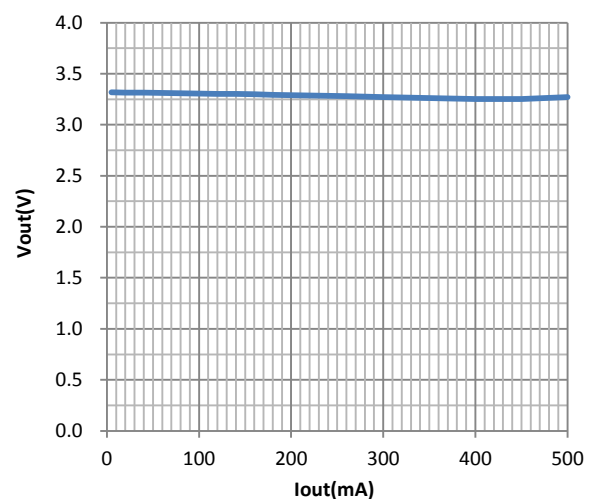

ORDERING INFORMATION

BL8075 ①②③④⑤

Code	Description
①	Temperature&Rohs: C:-40~85°C ,Pb Free Rohs Std.
②	Package type: B5:SOT-23-5 C3:SOT-89-3
③	Packing type: TR:Tape&Reel (Standard)
④	Output voltage: e.g. 12=1.2V 15=1.5V 50=5.0V
⑤	Voltage accuracy: 1= ± 1% Blank(default)= ± 2%

ABSOLUTE MAXIMUM RATING

Parameter	Value	
Max Input Voltage	20V	
Operating Junction Temperature(Tj)	125°C	
Ambient Temperature(Ta)	-40°C -85°C	
Power Dissipation (P _D @Ta=25°C)	SOT-23-5	400mW
	SOT-89-3	500mW
Storage Temperature(Ts)	-40°C -150°C	
Lead Temperature & Time	260°C,10S	

Note:

Exceed these limits to damage to the device.
Exposure to absolute maximum rating conditions may affect device reliability.

PIN CONFIGURATION

Product Classification		BL8075CB5TR□□□	
Marking		SOT-23-5	
PXYW	P:Product Code	VIN 1	5 VOUT
	X:Output Voltage	GND 2	PXYW
	YW:Date Code	EN 3	4 NC
Product Classification		BL8075CC3TR□□□	
Marking		SOT-89-3	
PXX LLXYW	P:Product Code	1 GND	
	XX:Output Voltage	2 VIN	
	LL:LOT NO.	3 VOUT	
	X:FAB Code	1 2 3	
	YW:Date Code		

Y: The Year of manufacturing, "1" stands for year 2011, "2" stands for year 2012, and "8" stands for year 2018.
W: The week of manufacturing. "A" stands for week 1, "Z" stands for week 26, "Ā" stands for week 27, "Z̄" stands for week 52.

RECOMMENDED WORK CONDITIONS

Item	Min	Recom- mended	Max.	Unit
Input Voltage Range	3		16	V
Ambient Temperature	-40		85	°C

ELECTRICAL CHARACTERISTICS

(Test Conditions: $C_{in}=1\mu F$, $C_{out}=1\mu F$, $T_a=25^\circ C$, Unless Otherwise Specified)

Symbol	Parameter	Conditions	Min	Type	Max	Units
V_{in}	Input Voltage		3		16	V
V_{out}	Output Voltage	$V_{out}>1.5V$	$V_{in}-V_{out}=1.2V$ $1mA \leq I_{out} \leq 30mA$	Vout	$V_{out} \times 0.98$	V
		$V_{out} \leq 1.5V$			-0.03	
$I_{out(Max.)}$	Maximum Output Current	$V_{in}-V_{out}=1.2V$	500			mA
Dropout Voltage	Input-Output Voltage Differential	$I_{out}=300mA$, $V_{out} = 3.3V$		600		mV
$\frac{\Delta V_{out}}{\Delta V_{in} \cdot V_{out}}$	Line Regulation	$I_{out}=10mA$, $4V \leq V_{in} \leq 16V$		0.2	0.3	%/V
ΔV_{out}	Load Regulation	$V_{in} = \text{Set } V_{out} + 1V$ $1mA \leq I_{out} \leq 100mA$		20	40	mV
I_q	Quiescent Current	$V_{in} = \text{Set } V_{out} + 1V$, $V_{EN} = "H"$		10	20	μA
		$V_{in} = 12V$, $V_{EN} = 0V$			1	μA
$\frac{\Delta V_{out}}{\Delta T \cdot V_{out}}$	Output Voltage Temperature Coefficient	$I_{out}=10mA$		± 100		ppm/ $^\circ C$
V_{enh}	EN Input Voltage "H"		1.5		V_{in}	V
V_{enl}	EN Input Voltage "L"		0		0.4	V
	Thermal Shutdown			150		$^\circ C$

BLOCK DIAGRAM

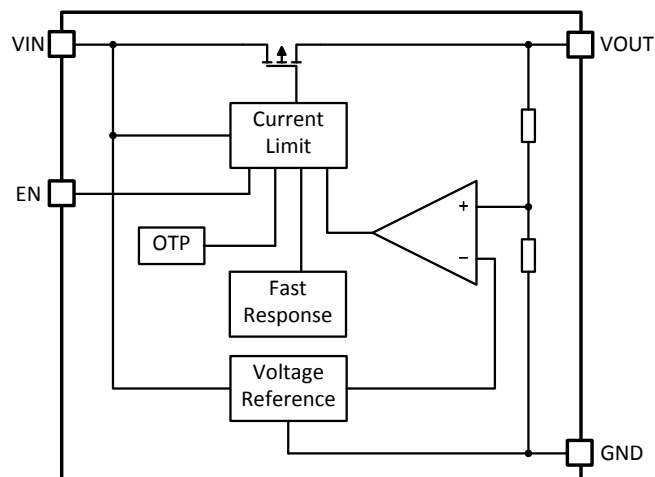

EXPLANATION

BL8075 is a series of low dropout voltage and low power consumption regulator. Its application circuit is very simple, which only needs two outside capacitors. It is composed of these modules: high accuracy voltage reference, current limit circuit, error amplifier, output driver and power transistor.

Current Limit module can keep chip and power system away from danger when load current is more than 500mA.

BL8075 uses trimming technique to assure the accuracy of output value within $\pm 2\%$, at the same time, temperature compensation is elaborately considered in this chip, which makes BL8075's temperature coefficient within $\pm 100\text{ppm}/^\circ C$.

TYPICAL PERFORMANCE CHARACTERISTICS

Load Regulation

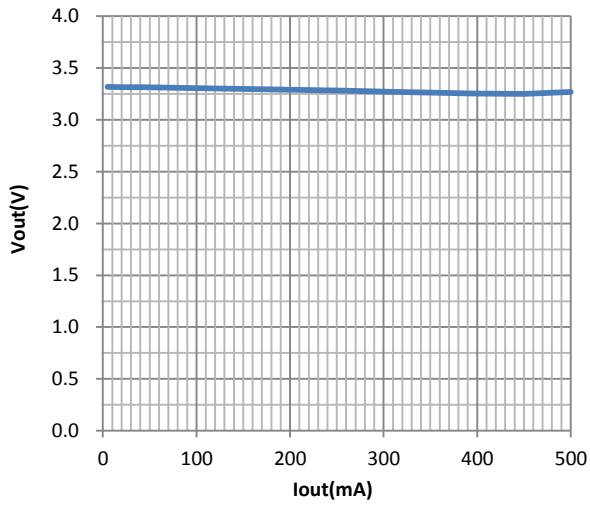

Line Regulation

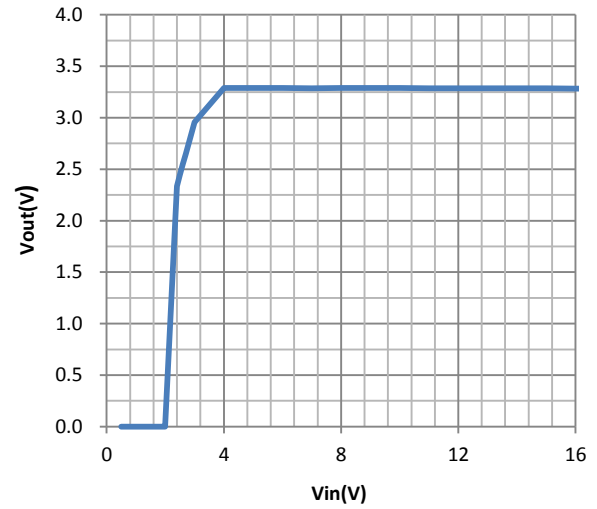

Dropout

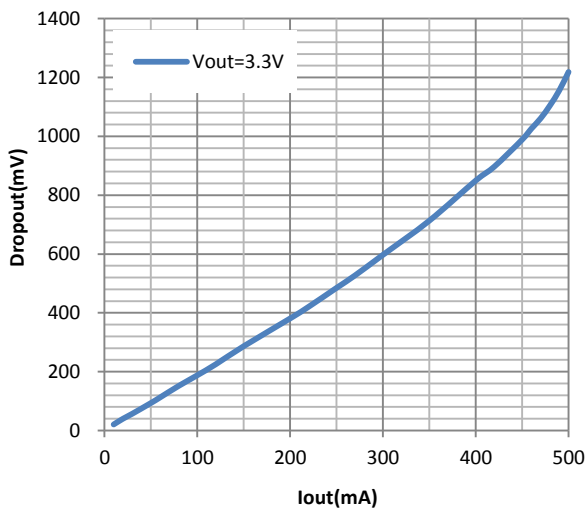

Iq

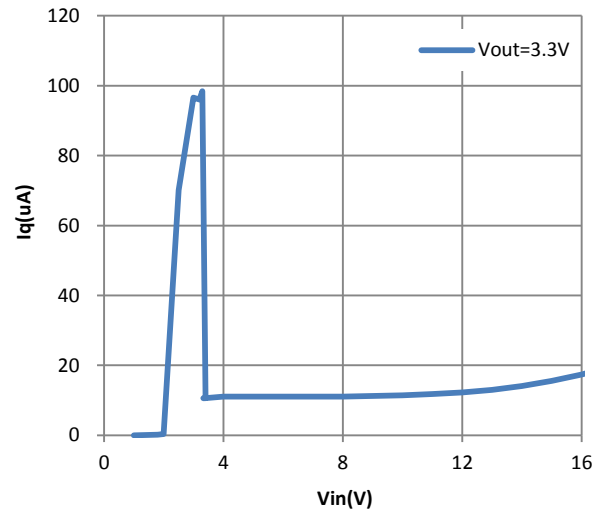

Current Limit

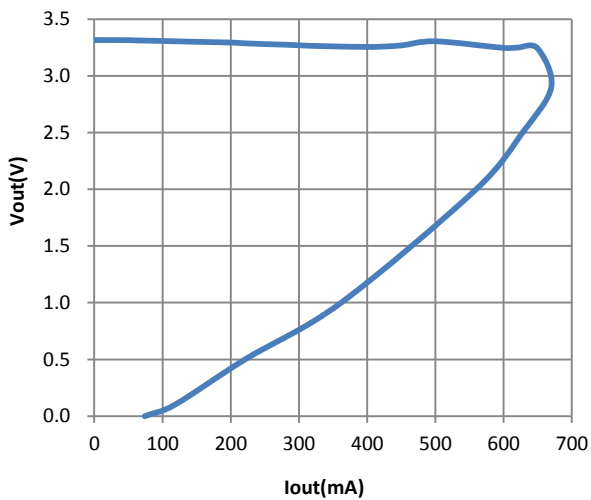

Line transient response

Vin=5V~6V, Iout=10mA
Ch1—Vin, Ch2—Vout

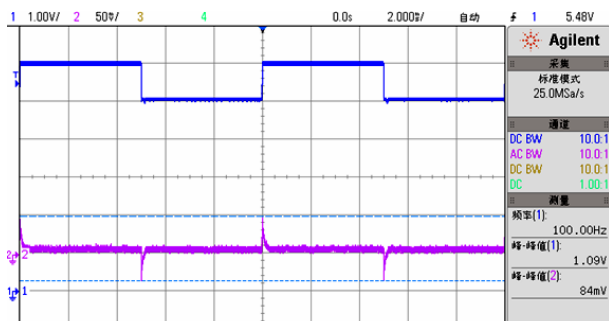

Load transient response

Vin=5V, Iout=5mA~150mA
Ch2—Vout, Ch4—Iout

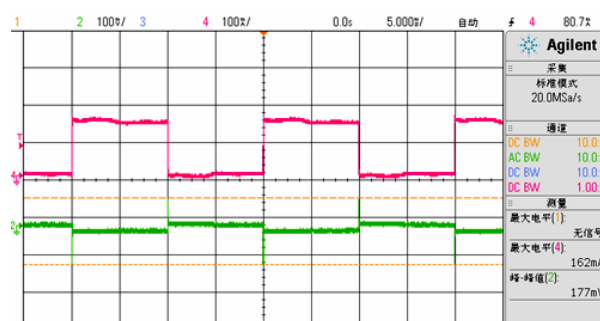

PACKAGE LINE

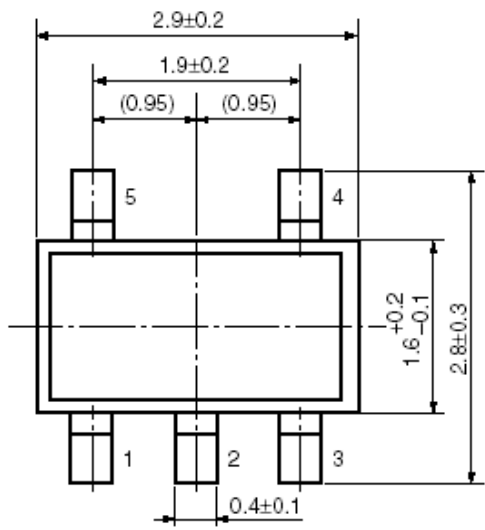
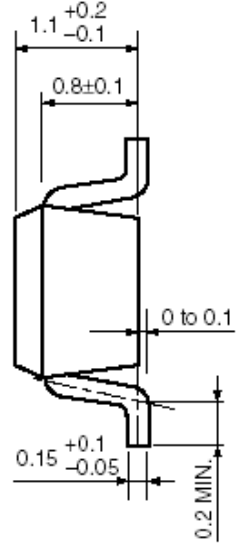
Package	SOT-23-5	Devices per reel	3000Pcs	Unit	mm
Package dimension: <div style="display: flex; justify-content: space-around; align-items: center;">   </div>					

BL8075

Package	SOT-89-3	Devices per reel	1000Pcs	Unit	mm
Package Dimension:					
<p>The technical drawing illustrates the BL8075 SOT-89-3 package in three views: top, side, and bottom. The top view shows a rectangular body with a width of 4.5 ± 0.1 mm and a central circular feature with a diameter of $\varnothing 1.0$ mm. A trapezoidal feature on top has a width of 1.6 ± 0.2 mm and a height of 0.4 mm. The body height is 2.5 ± 0.1 mm, with a maximum total height of 4.25 mm. Three leads are shown at the bottom, labeled 1, 2, and 3, with a minimum lead height of 0.8 mm. The side view shows a trapezoidal profile with a top width of 1.5 ± 0.1 mm and a bottom width of 0.4 ± 0.1 mm. The bottom view shows the lead spacing: the distance between lead 1 and 2 is 1.5 ± 0.1 mm, and between lead 2 and 3 is 1.5 ± 0.1 mm. The distance from the center of the body to lead 1 and lead 3 is 0.42 ± 0.2 mm. The lead height is 0.47 ± 0.1 mm.</p>					

单击下面可查看定价，库存，交付和生命周期等信息

[>>BELLING\(上海贝岭\)](#)