

0.8uA Low Power Consumption Regulator with Enable

DESCRIPTION

The BL8077 is a group of positive voltage output, low power consumption, low dropout voltage regulator. The very low power consumption of BL8077 (0.8uA, Typ) can greatly improve natural life of batteries. The BL8077 includes high accuracy voltage reference, error amplifier and output driver module with discharge capability. And it also provides foldback short-circuit protection, thermal protection and output current limit function.

The BL8077 can provide output value of fixed version as 1.2V, 1.8V, 2.5V, 2.8V, 3V, and 3.3V. It also can be customized on command.

BL8077 is available in SOT23-5 and DFN1x1-4 which are lead free.

FEATURES

- Maximum output current:300mA
- Low power consumption: 0.8uA (Typ.)
- Stand-by current: less than 0.1uA
- Operating input voltage:1.8V~5.5V
- Low dropout voltage:
150mV @100mA @Vout=3.3V (Typ.)
- Low temperature coefficient: $\pm 100\text{ppm}/^\circ\text{C}$
- Build-in chip enable and discharge circuit
- Built-in output current limit circuit

APPLICATIONS

- Mobile phones
- Battery powered equipment
- Cordless phones, wireless communication equipment
- Cameras, video recorders
- Portable AV equipment
- PDAs

TYPICAL APPLICATION

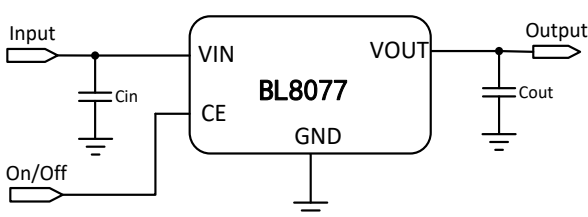

Note: Input capacitor ($C_{in}=1\mu\text{F}$) and output capacitor ($C_{out}=1\mu\text{F}$) are recommended in all application circuit.

ELECTRICAL CHARACTERISTICS

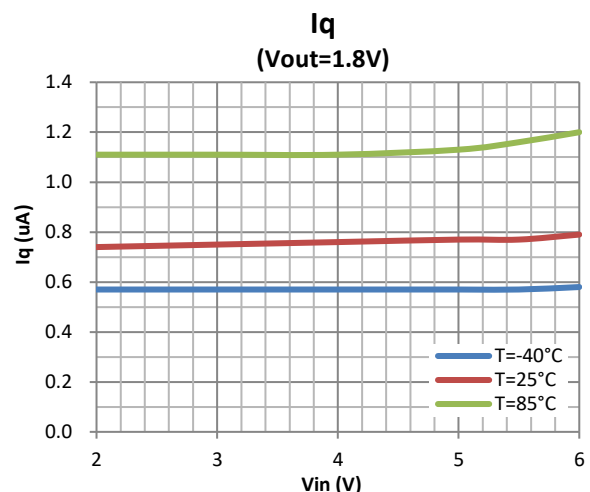

ORDERING INFORMATION

BL8077 ①②③④

Code	Description
①	Temperature&RoHS: C:-40~85°C ,Pb Free RoHS Std.
②	Package type: B5:SOT-23-5 KE:DFN1x1-4
③	Packing type: TR:Tape&Reel (Standard)
④	Output voltage: e.g. 12=1.2V 18=1.8V 33=3.3V

MARKING DESCRIPTON

AN: Product Code

X: Output Voltage(for SOT23-5)

Vout	Code	Vout	Code	Vout	Code
1.2V	2	2.5V	5	3.0V	0
1.8V	8	2.8V	8	3.3V	3

XX: Output Voltage (for DFN1X1-4)

Y: The Year of manufacturing, "1" stands for year 2011, "2" stands for year 2012, and "8" stands for year 2018.

W: The week of manufacturing. "A" stands for week 1, "Z" stands for week 26, "A" stands for week 27, "Z" stands for week 52.

ABSOLUTE MAXIMUM RATING

Parameter		Value
Max input voltage		8V
operating junction temperature(T _J)		125°C
Output current		400mA ¹
Ambient temperature(T _A)		-40°C -85°C
Package thermal resistance (θ _{JA})	SOT-23-5	220°C / W
	DFN1x1-4	170°C / W
Power dissipation	SOT-23-5	400mW
	DFN1x1-4	600mW
Storage temperature(T _S)		-40°C -150°C
Lead temperature & time		260°C,10S

Note:

1) $I_{out} = PD / (V_{in} - V_{out})$

2) Exceed these limits to damage to the device. Exposure to absolute maximum rating conditions may affect device reliability.

PIN CONFIGURATION

Product classification	BL8077CB5TR□□
AN: Product code	
X: Output voltage	
YW: Date code	
Product classification	BL8077CKETR□□
XX: Output Voltage	
VIN	Supply voltage input
GND	Ground pin
CE	Chip enable
NC	No connection
VOUT	Output voltage

ELECTRICAL CHARACTERISTICS

Test Conditions: $C_{IN}=1\mu F$, $C_{OUT}=1\mu F$, $T_A=25^\circ C$, unless otherwise specified.

Symbol	Parameter	Conditions	Min	Typ	Max	Units
V_{IN}	Input voltage		1.8		5.5	V
V_{OUT}	Output voltage	$V_{out}\leq 1.5V, V_{in}=2.5V, I_{out}=0mA$	$V_{out}\times 0.98$	Vout	$V_{out}\times 1.02$	V
		$V_{out}>1.5V, V_{in}=V_{out}+1V, I_{out}=0mA$				
$I_{OUT(MAX)}$	Max output current	$V_{out}\leq 1.5V, V_{in}=2.5V$	300			mA
		$V_{out}>1.5V, V_{in}=V_{out}+1V$				
V_{DROP}^1	Dropout voltage	$V_{out}=1.2V, I_{out}=300mA$		1200	1450	
		$V_{out}=1.8V, I_{out}=300mA$		780	950	mV
		$V_{out}=3.3V, I_{out}=300mA$		460	550	mV
$\frac{\Delta V_{out}}{\Delta V_{in} \cdot V_{out}}$	Line regulation	$I_{out}=10mA, V_{out}\leq 1.3V, 1.8V\leq V_{in}\leq 5V$		0.5		%V
		$I_{out}=10mA, V_{out}>1.3V, V_{out}+0.5V\leq V_{in}\leq 5V$				
ΔV_{out}	Load regulation	$V_{out}\leq 1.5V, V_{in}=2.5V, 0mA\leq I_{out}\leq 300mA$		55	85	mv
		$V_{out}>1.5V, V_{in}=V_{out}+1V, 0mA\leq I_{out}\leq 300mA$				
I_{SS}	Supply current	$V_{in}=\text{Set } V_{out}+1V$		0.8	1.5	μA
$I_{STANDBY}$	Supply current (standby)	$V_{in}=\text{Set } V_{out}+1V, V_{ce}=\text{GND}$		0.01	0.1	μA
I_{SHORT}	Short current limit	$V_{out}=0V$		60		mA
$\frac{\Delta V_{out}}{\Delta T \cdot V_{out}}$	Output voltage temperature coefficient	$I_{out}=10mA$		± 100		ppm/ $^\circ C$
$R_{DISCHARGE}$	Discharge resistor	$CE=0, V_{out}=3V$		250	300	ohm
T_{SD}	Thermal shutdown temp	$V_{in}=\text{Set } V_{out}+1V, I_{out}=10mA$		160		$^\circ C$
T_{SH}	Thermal shutdown hysteresis	$V_{in}=\text{Set } V_{out}+1V, I_{out}=10mA$		30		$^\circ C$
V_{CEL}	CE "L" level voltage	$V_{in}=\text{Set } V_{out}+1V$	0		0.4	V
V_{CEH}	CE "H" level voltage	$V_{in}=\text{Set } V_{out}+1V$	1.5		5.5	V

Note:

1) $V_{DROP}=V_{IN1}-(V_{OUT2}\times 0.98)$, V_{OUT2} is the output voltage when $V_{IN}=V_{OUT1}+1.0V$ and $I_{OUT}=300mA$. V_{IN1} is the input voltage at which the output voltage becomes 98% of V_{OUT1} after gradually decreasing the input voltage.

BLOCK DIAGRAM

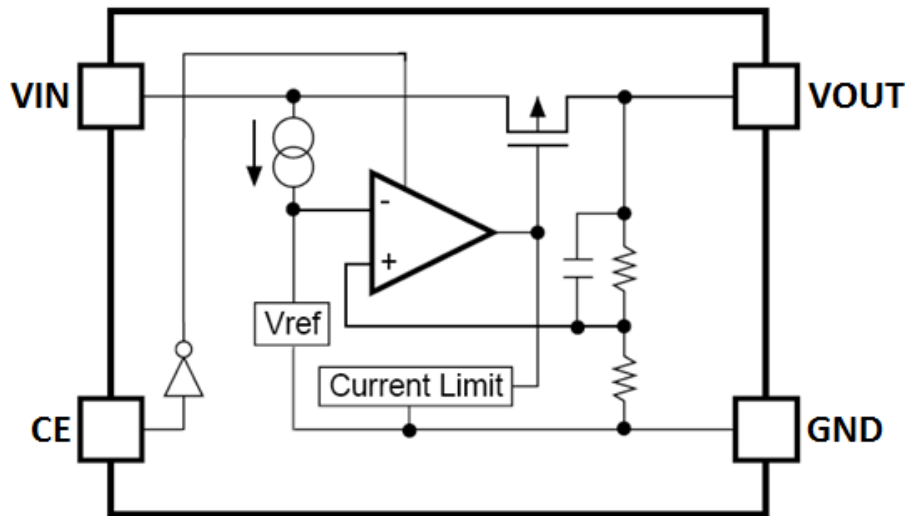

EXPLANATION

Output Voltage

The BL8077 can provide output value of fixed version as 1.2V, 1.8V, 2.5V, 2.8V, 3V, and 3.3V. It also can be customized on command.

Short Protection Circuit

The BL8077 regulator offers circuit protection by means of a built-in foldback circuit. When the load current reaches the current limit level, the fixed current limiter circuit operates and output voltage drops. As a result of this drop in output voltage, the foldback circuit operates, the output voltage drops further and output current decreases. When the output pin is shorted, a current of about 60mA flows.

CE Pin

The IC's internal circuitry can be operated or shutdown via the signal from the CE pin with the BL8077. Note that the BL8077 regulator is "High Active/No Pull-Down", operations will become unstable with the CE pin open. We suggest that you use this IC with either a VIN voltage or a GND voltage input at the CE pin. If this IC is used with the correct specifications for the CE pin, the operational logic is fixed and the IC will operate normally. Otherwise, supply current may increase as a result of through current in the IC's internal circuitry.

Thermal Shutdown

When the junction temperature of the built-in driver transistor reaches the temperature limit, the thermal shutdown circuit operates and the driver transistor will be set to OFF. The IC resumes its operation when the thermal shutdown function is released and the IC's operation is automatically restored because the junction temperature drops to the level of the thermal shutdown release voltage.

TYPICAL PERFORMANCE CHARACTERISTICS

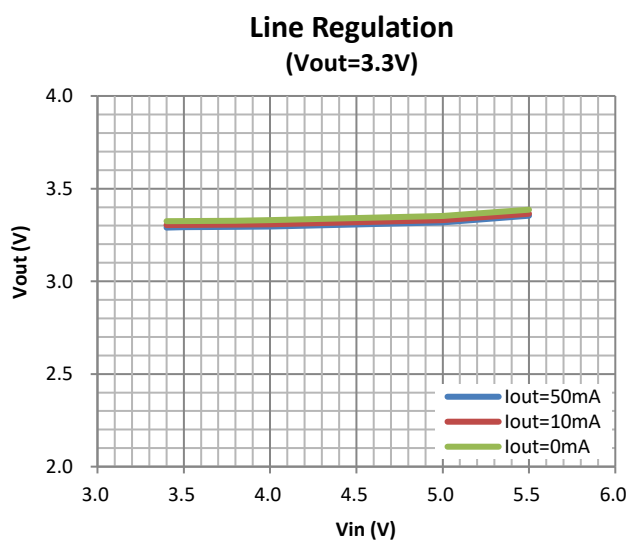
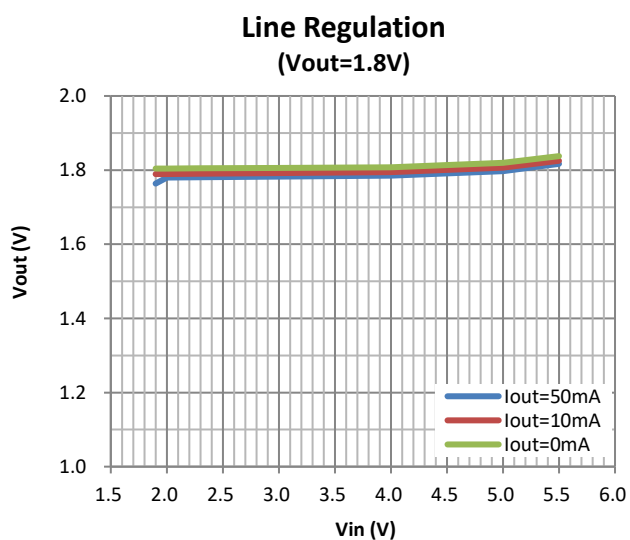
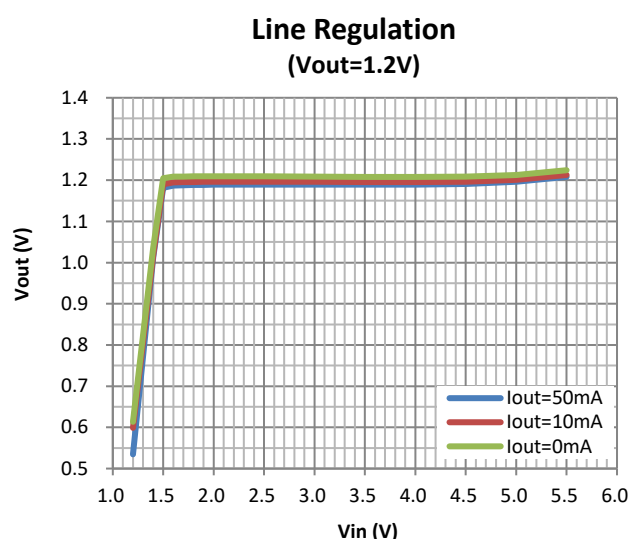
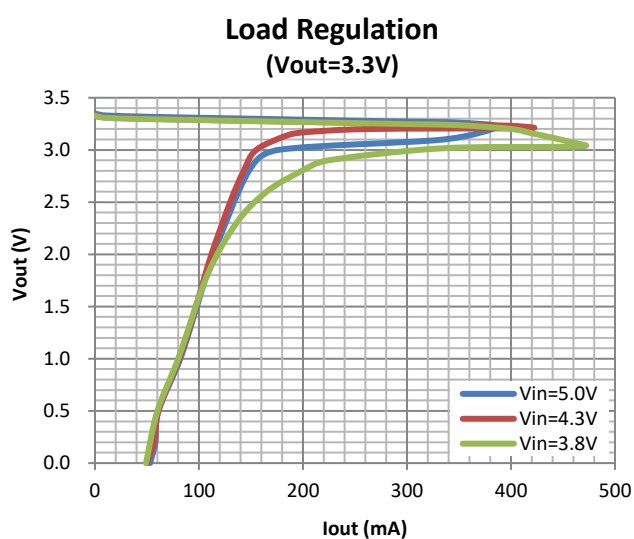
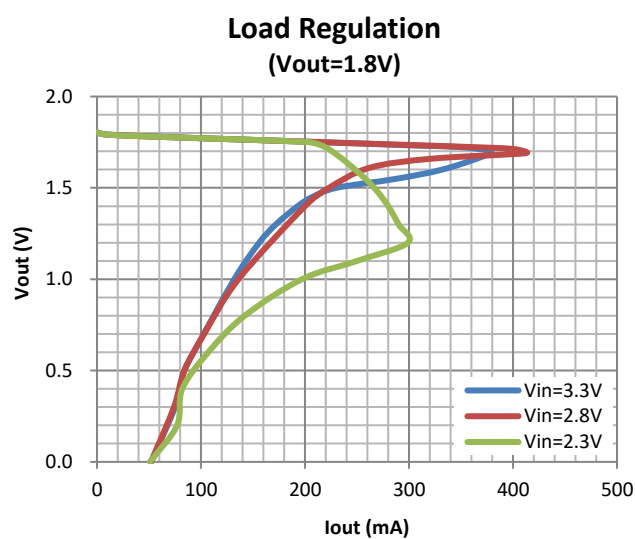
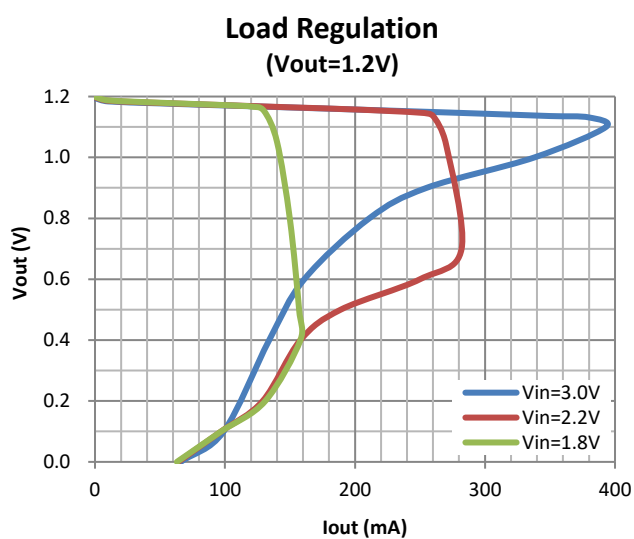

Dropout Voltage vs. Temp
(Vout=1.2V)

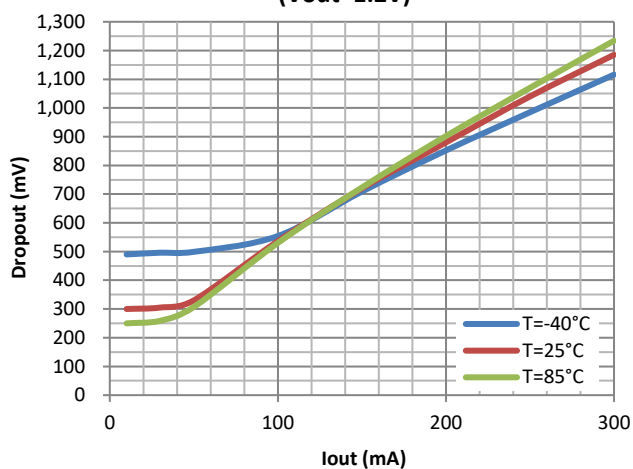

Dropout Voltage vs. Temp
(Vout=1.8V)

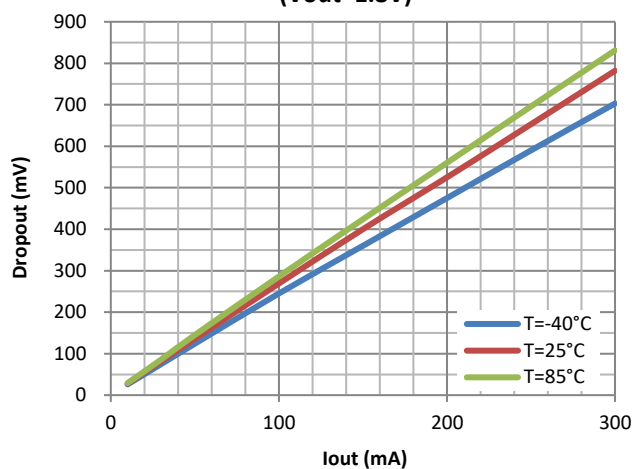

Dropout Voltage vs. Temp
(Vout=3.3V)

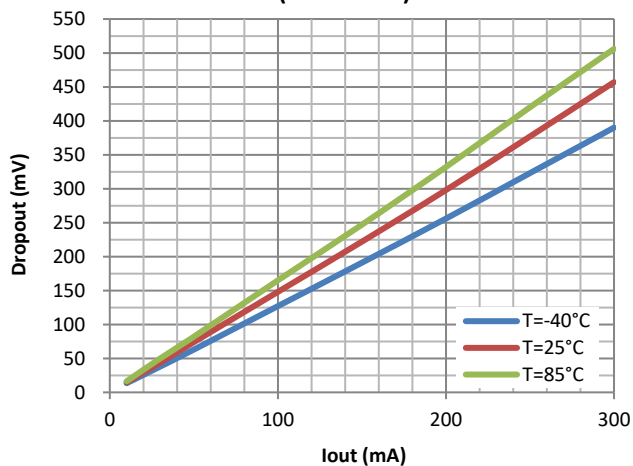

Iq
(Vout=1.2V)

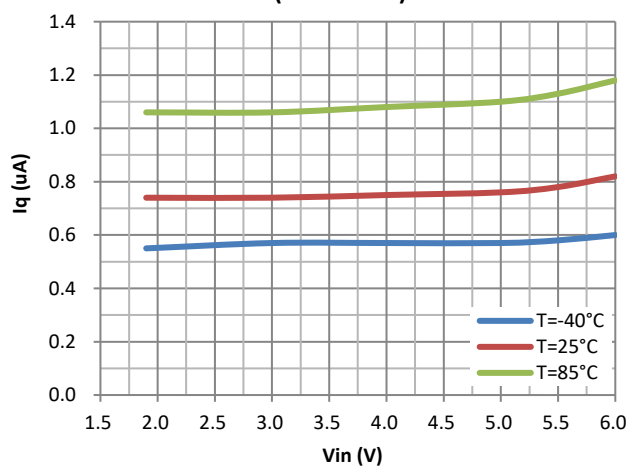

Iq
(Vout=1.8V)

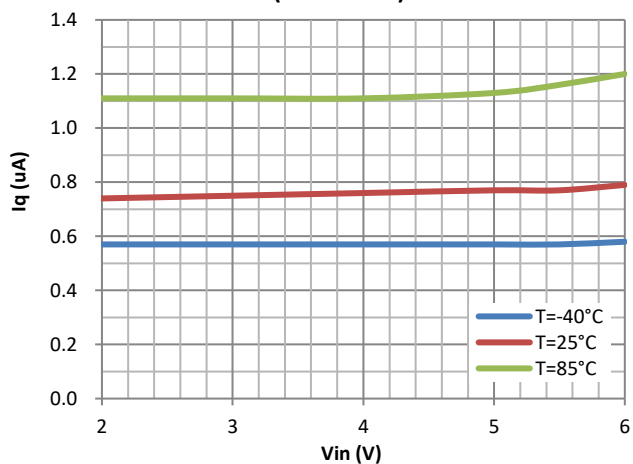

Iq
(Vout=3.3V)

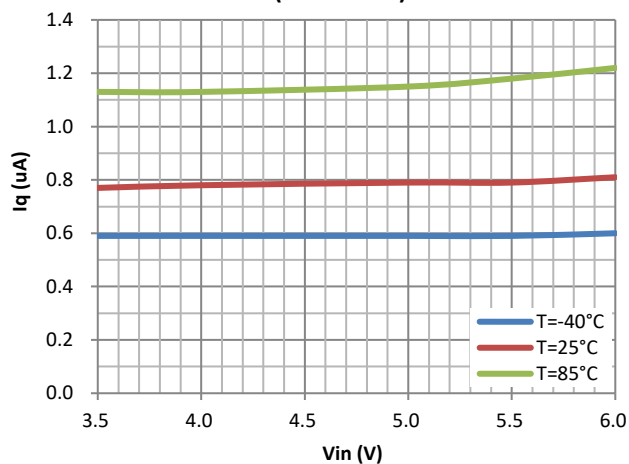

Line Transient Response

Vin=2.8-3.8V, Iout=10mA, Vout=1.8V

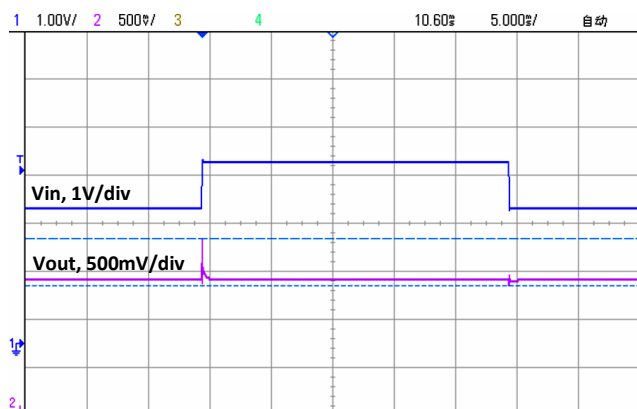

Load Transient Response

Iout=1-300mA, Vin=2.8V, Vout=1.8V

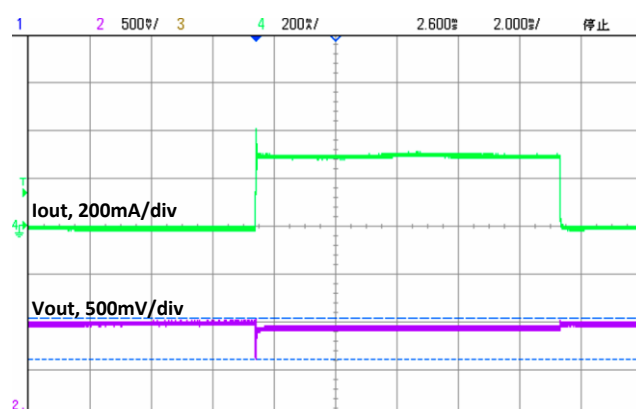

CE rising response time

Iout=30mA, Vin=2.8V, Vce=0V-->2V, Vout=1.8V

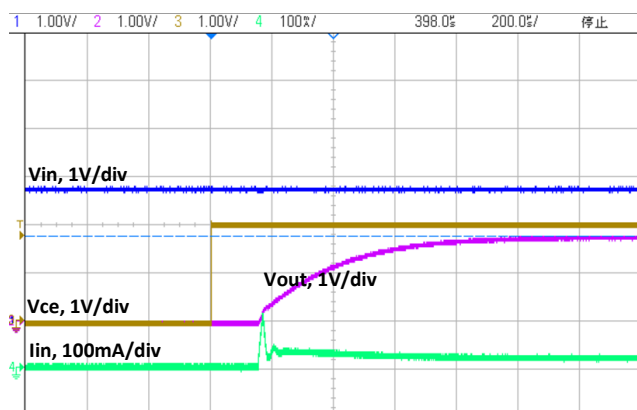

Rising response time

Vin=Vce=2.2V, Iout=30mA, Vout=1.2V

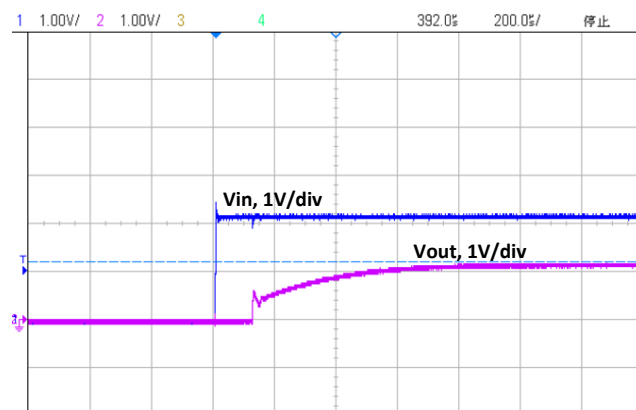

Rising response time

Vin=Vce=2.8V, Iout=30mA, Vout=1.8V

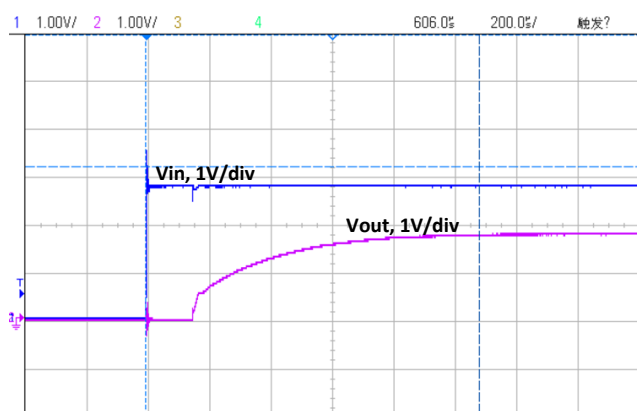

Rising response time

Vin=Vce=4.3V, Iout=30mA, Vout=3.3V

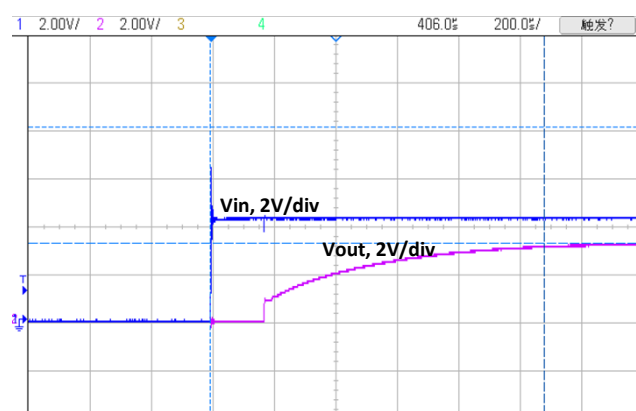

单击下面可查看定价，库存，交付和生命周期等信息

[>>BELLING\(上海贝岭\)](#)