

1. Description

BLG40T120FDH is obtained by advanced Trench Field Stop (T-FS) technology which reduces the conduction loss, improve switching performance, and enhance the avalanche energy. The IGBT is suitable device for UPS, Welding, and high-speed switching.

KEY CHARACTERISTICS

Parameter	Value	Unit
V_{CES}	1200	V
I_C	40	A
$V_{CE(sat).typ}$	1.9	V
$P_D (T_C=25^\circ C)$	367	W

FEATURES

- Fast Switching
- Low $V_{CE(sat)}$
- Positive temperature coefficient
- Very soft, fast recovery anti-parallel diode
- RoHS product

APPLICATIONS

- UPS
- Welding Converters
- Converters with high switching frequency

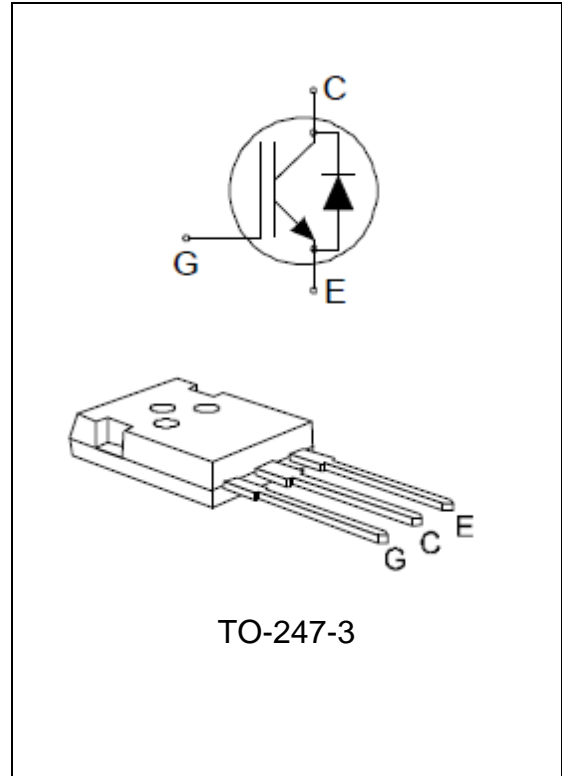

ORDERING INFORMATION

Ordering Codes	Package	Product Code	Packing
BLG40T120FDH-F	TO-247	G40T120FDH	Tube

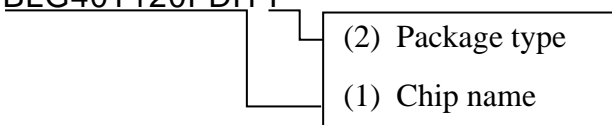
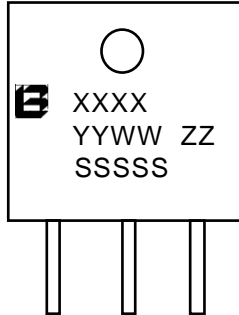
<p>BLG40T120FDH-F</p>  <p>(1) BLG40T120FDH:1200V 40A (2) F:TO-247</p>	 <p>XXXX: Product Code YYWW: Year & Week ZZ: Assembly Code SSSS: Lot Code</p>
--	---

2. ABSOLUTE RATINGS

at $T_C = 25^\circ\text{C}$, unless otherwise specified

Symbol	Parameter	Rating	Units
V_{CES}	Collector-Emitter Voltage	1200	V
I_C	Collector Current @ $T_C=25^\circ\text{C}$	80	A
	Collector Current @ $T_C=100^\circ\text{C}$	40	A
I_{CM}	Pulsed Collector Current (Note1) @ $T_C=25^\circ\text{C}$	160	A
I_F	Diode Continuous Forward Current @ $T_C=25^\circ\text{C}$	80	A
	Diode Continuous Forward Current @ $T_C=100^\circ\text{C}$	40	A
I_{FM}	Diode Maximum Forward Current @ $T_C=25^\circ\text{C}$	160	A
V_{GES}	Gate-Emitter Voltage	± 20	V
P_D	Power Dissipation @ $T_C=25^\circ\text{C}$	367	W
T_{Jmax}, T_{stg}	Operating Junction and Storage Temperature Range	150, -55 to 150	$^\circ\text{C}$
T_L	Maximum Temperature for Soldering	260	$^\circ\text{C}$

3. Thermal characteristics

Symbol	Parameter	RATINGS	Units
$R_{\theta JC}$	Junction-to-Case (IGBT)	0.34	$^\circ\text{C}/\text{W}$
$R_{\theta JC}$	Junction-to-Case (Diode)	0.55	$^\circ\text{C}/\text{W}$
$R_{\theta JA}$	Junction-to-Ambient	40	$^\circ\text{C}/\text{W}$

4. Electrical Characteristics

at $T_C = 25^\circ\text{C}$, unless otherwise specified

OFF Characteristics						
Symbol	Parameter	Test Conditions	Values			Units
			Min.	Typ.	Max.	
V_{CES}	Collector-Emitter Breakdown Voltage	$V_{GE} = 0\text{V}$, $I_C = 250\mu\text{A}$	1200	--	--	V
I_{CES}	Collector-Emitter Leakage Current	$V_{CE} = 1200\text{V}$, $V_{GE} = 0\text{V}$	--	--	250	μA
$I_{GES(F)}$	Gate-Emitter Leakage Current	$V_{GE} = +20\text{V}$	--	--	600	nA
$I_{GES(R)}$	Gate-Emitter Reverse Leakage	$V_{GE} = -20\text{V}$	--	--	-600	nA

ON Characteristics

Symbol	Parameter	Test Conditions	Values			Units
			Min.	Typ.	Max.	
$V_{CE(sat)}$	Collector-Emitter Saturation Voltage	$V_{GE} = 15V$, $I_C = 40A$	--	1.9	2.4	V
$V_{GE(TH)}$	Gate Threshold Voltage	$V_{CE} = V_{GE}$, $I_C = 1mA$	5.0	5.8	6.5	V

Pulse width $t_p \leq 300\mu s$, $\delta \leq 2\%$

Dynamic Characteristics

Symbol	Parameter	Test Conditions	Values			Units
			Min.	Typ.	Max.	
C_{iss}	Input Capacitance	$V_{GE}=0V$ $V_{CE}=25V$ $f = 1.0MHz$	--	3630	--	pF
C_{oss}	Output Capacitance		--	180	--	
C_{rss}	Reverse Transfer Capacitance		--	90	--	
Q_g	Total Gate Charge	$I_C=40A$, $V_{CE}=960V$ $V_{GE}=15V$		245		nC

Switching Characteristics

Symbol	Parameter	Test Conditions	Values			Units
			Min.	Typ.	Max.	
$t_{d(ON)}$	Turn-on Delay Time	$I_C = 40A$ $V_{CE} = 600V$ $V_{GE} = 15V$ $R_G = 10\Omega$ $T_J = 25^\circ C$ Inductive Load	--	48	--	ns
t_r	Rise Time		--	90	--	
$t_{d(OFF)}$	Turn-Off Delay Time		--	275	--	
t_f	Fall Time		--	55	--	
E_{on}	Turn-On Switching Loss		--	5.8	--	mJ
E_{off}	Turn-Off Switching Loss		--	1.5	--	
E_{ts}	Total Switching Loss		--	7.30	--	

Diode Characteristics

Symbol	Parameter	Test Conditions	Values			Units
			Min.	Typ.	Max.	
V_F	Diode Forward Voltage	$I_F=20A$	--	2	2.5	V
T_{rr}	Reverse Recovery Time	$I_F=20A$, $di/dt=200A/\mu s$, $T_J=25^\circ C$	--	73	--	ns
Q_{rr}	Reverse Recovery Charge		--	654	--	nC
I_{rrm}	Reverse Recovery Current		--	14.9	--	A

Note1: Pulse width limited by maximum junction temperature

5. Characteristics Curves

Figure 1. Forward Bias Safe Operating Area

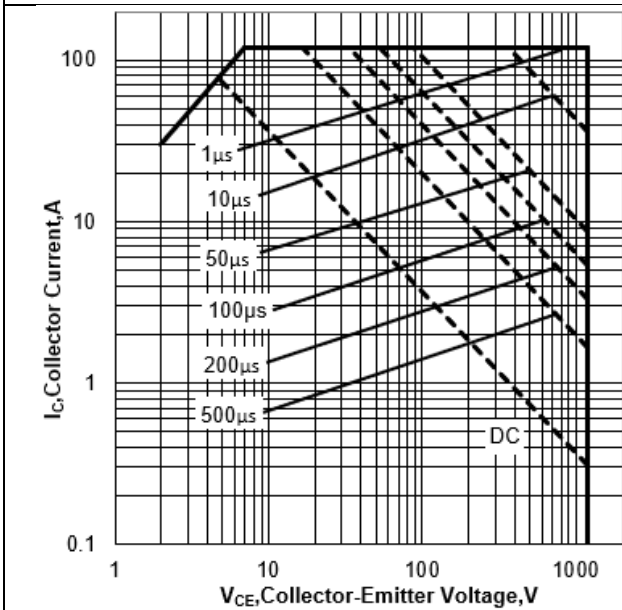

Figure 2. Power Dissipation vs Case Temperature

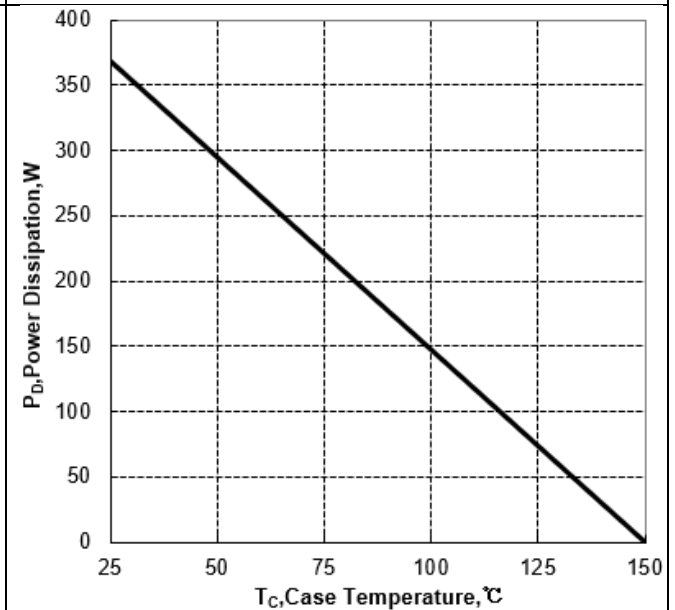

Figure 3. Collector Current vs Case Temperature

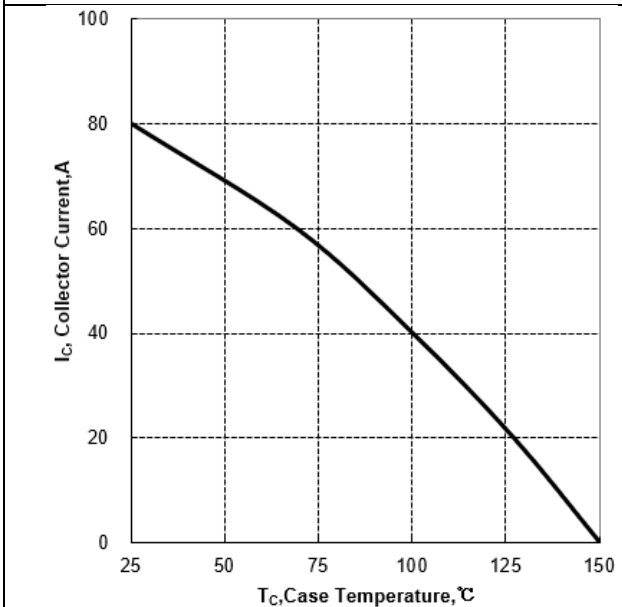

Figure 4. Typical Transfer Characteristics

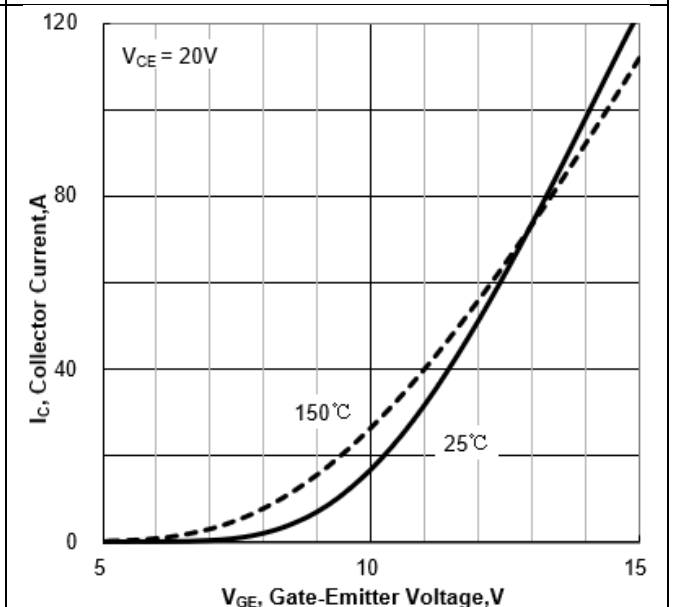

Figure 5. Typical Output Characteristics(T=25°C)

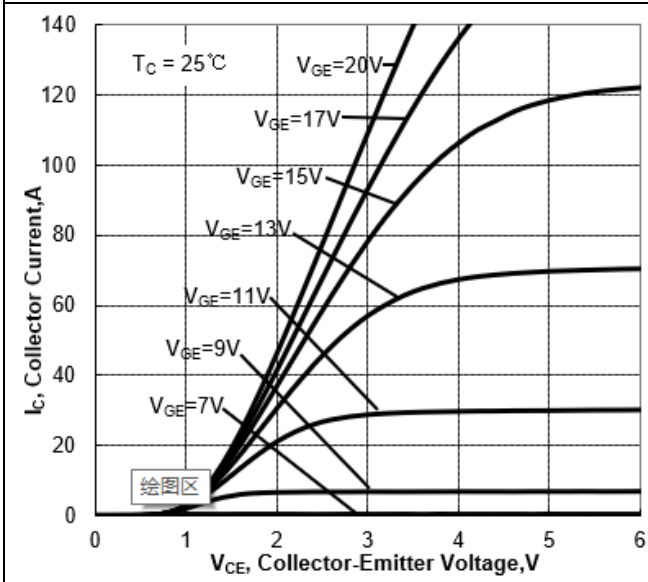

Figure 6. Typical Output Characteristics(T=150°C)

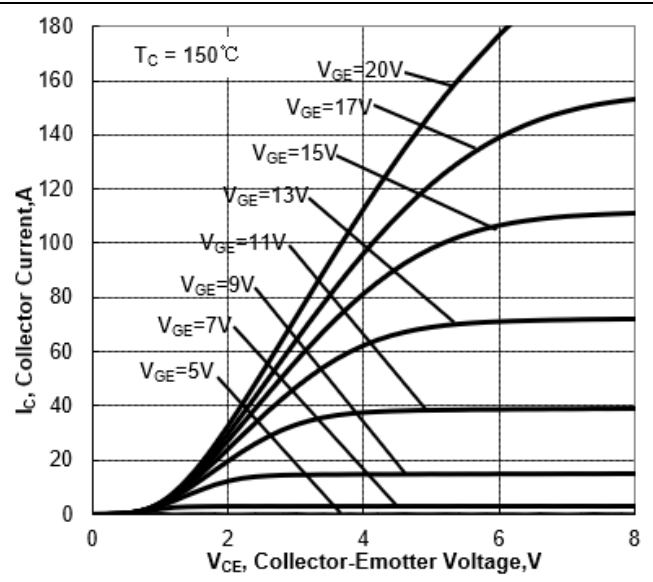

Figure 7. Typical Collector-Emitter Saturation Voltage vs Junction Temperature

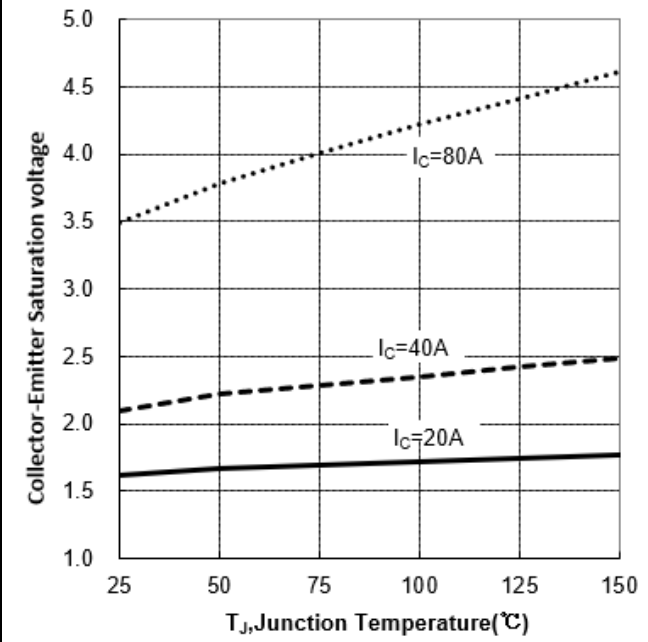

Figure 8. Typical Transfer Characteristics

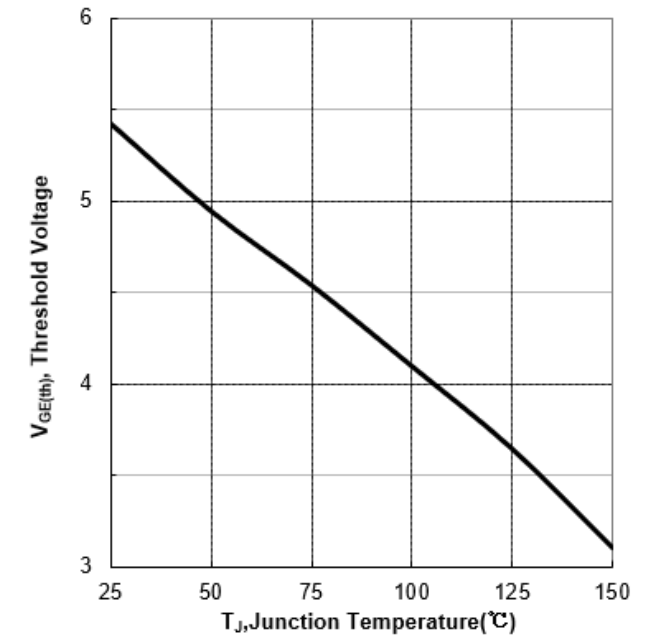

Figure 9. Typical Gate Charge

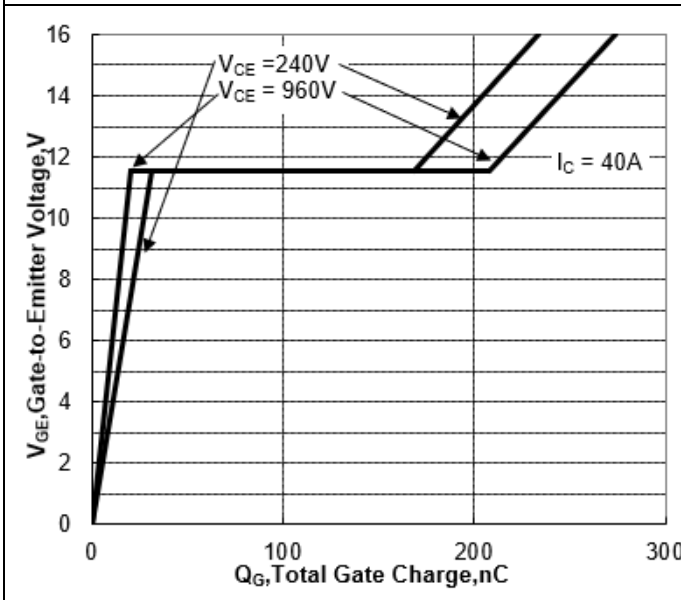

Figure 10. Typical Capacitance vs Collector-Emitter Voltage

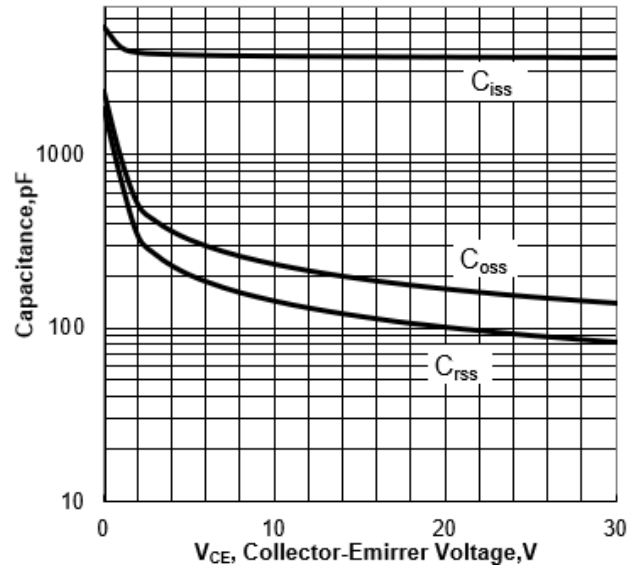

Figure 11. IGBT Transient Thermal Impedance vs Pulse Width

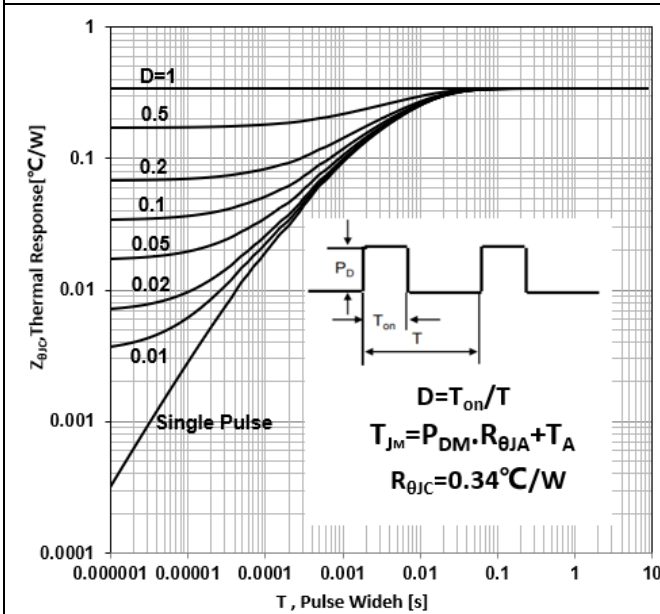

Figure 12. Diode Transient Thermal Impedance vs Pulse Width

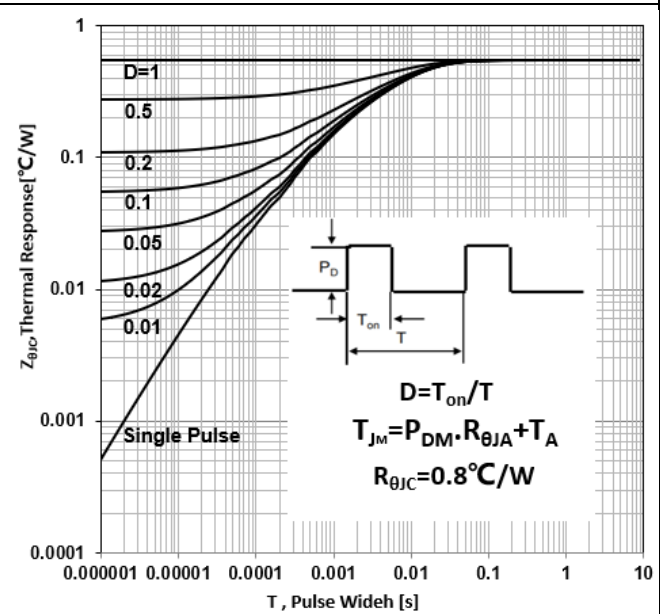
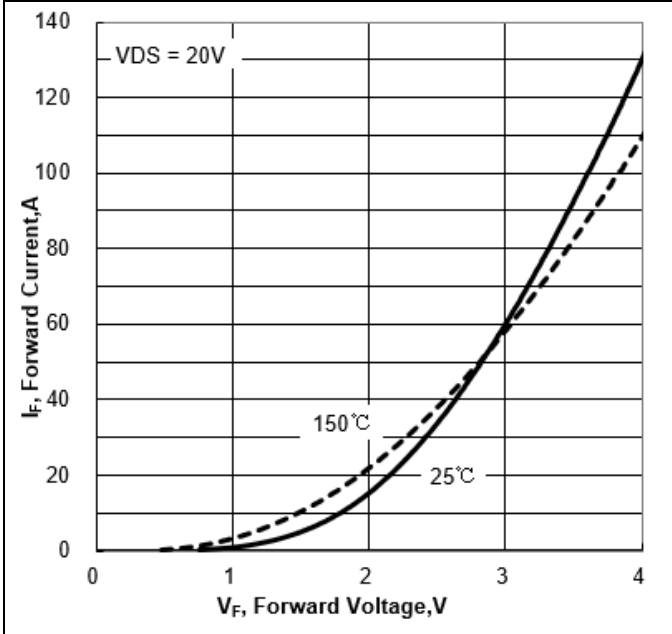
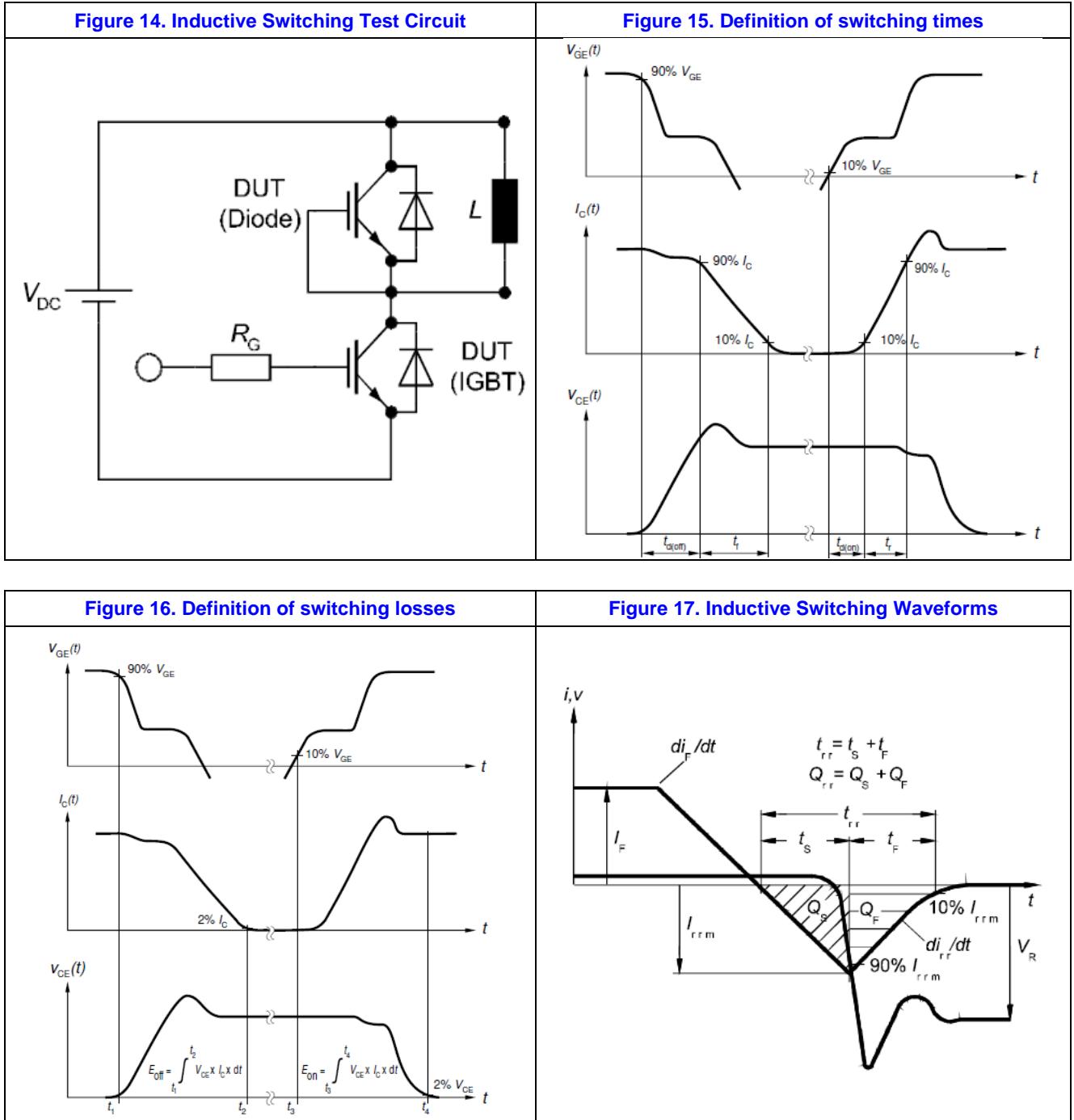

Figure 13. Typical Diode Forward Current vs Forward Voltage



6. Test Circuit and Waveform



7. Package Description

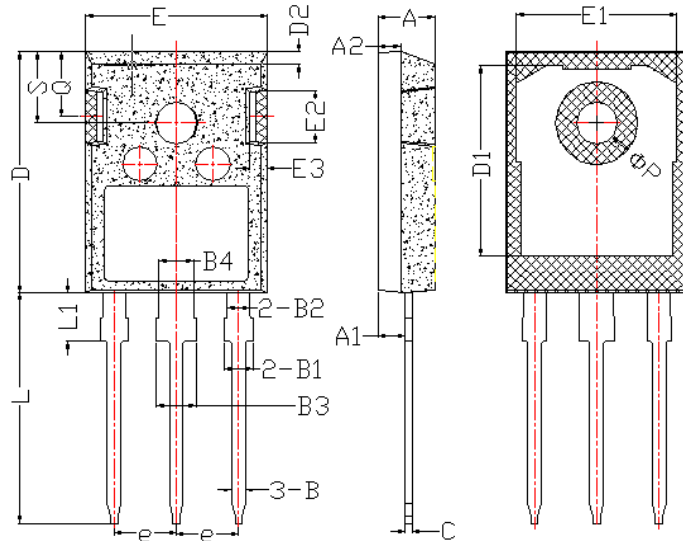

Items	Values(mm)	
	MIN	MAX
A	4.90	5.16
A1	2.27	2.53
A2	1.85	2.11
B	1.07	1.33
B1	1.90	2.41
B2	1.75	2.15
B3	2.87	3.38
B4	2.87	3.13
C	0.55	0.68
D	20.82	21.10
D1	16.25	17.65
D2	1.05	1.35
E	15.70	16.03
E1	13.10	14.15
E2	3.68	5.10
E3	1.68	2.60
e	5.44	
L	19.80	20.31
L1	4.17	4.47
ΦP	3.50	3.70
Q	5.49	6.00
S	6.04	6.30

TO-247 Package

NOTE:

1. Exceeding the maximum ratings of the device in performance may cause damage to the device, even the permanent failure, which may affect the dependability of the machine. Please do not exceed the absolute maximum ratings of the device when circuit designing.
2. When installing the heat sink, please pay attention to the torsional moment and the smoothness of the heat sink.
3. MOSFETs is the device which is sensitive to the static electricity, it is necessary to protect the device from being damaged by the static electricity when using it.
4. Shanghai Belling reserves the right to make changes in this specification sheet and is subject to change without prior notice.

CONTACT:

上海贝岭股份有限公司（总部）

地址：上海市宜山路 810 号

邮编：200233

电话：021-24261000

产品业务咨询及技术支持

电话：021-24261326

传真 2：021-64852222

邮箱 2：marketing@belling.com.cn

上海贝岭深圳分公司（华南区）

地址：深圳市福田区中心区民田路新华保险大厦 1510 室

邮编：518031

电话：0755-33336776 0755-33336770

传真：0755-33336788

上海贝岭北京办事处（华北区）

地址：北京市西城区新华里 16 号院锦官苑小区 10 号楼 1 单元 1505 室

邮编：100044

电话：010-64179374

传真：010-8835 9236

单击下面可查看定价，库存，交付和生命周期等信息

[>>BELLING\(上海贝岭\)](#)