

GENERAL DESCRIPTION

BL8071 series are a group of positive voltage output, high precise, and low power consumption voltage regulator. Voltages are selectable in 100mV steps within a range of 1.2V to 5.0V. It also can be customized on command.

BL8071 series have excellent load and line transient response and good temperature characteristics, which can assure the stability of chip and power system. And it uses trimming technique to guarantee output voltage accuracy within $\pm 2\%$.

BL8071 series are available in SOT-223 package, which are lead (Pb)- free.

FEATURES

- Low Quiescent Current: 100uA at 5V
- High PSRR: 70dB range to 1KHz
- Low Output Noise: 44uVRMS
- Low Dropout: 300mV at 1A load
- Maximum output current: 1.5A
- Highly Accurate: $\pm 2\%$
- Low ESR Ceramic Capacitor Compatible

APPLICATIONS

- Reference Voltage Source
- Battery Powered Equipment
- PC Peripherals
- Wireless Devices
- Instrumentation

TYPICAL APPLICATION

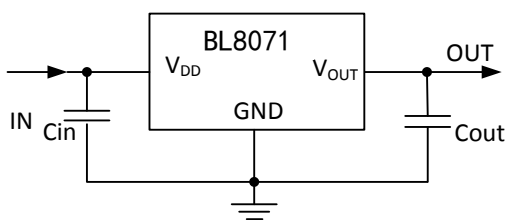

BLOCK DIAGRAM

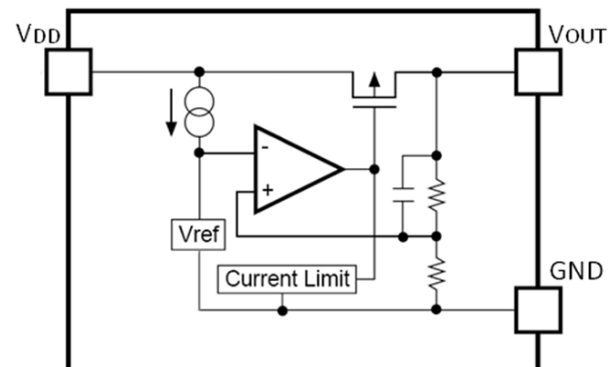

ORDERING INFORMATION

BL8071 ①②③④⑤

Code	Description
①	Temperature&Rohs: C:-40~85°C ,Pb Free Rohs Std.
②	Package type: LA: SOT-223 (A) LB: SOT-223 (B)
③	Packing type: TR:Tape&Reel (Standard)
④	Output voltage: e.g. 12=1.2V 18=1.8V 25=2.5V 33=3.3V 50=5.0V
⑤	Voltage accuracy: 1=±1%(Customized) Blank(default)=±2%

PIN CONFIGURATION

Product Classification		BL8071CLATR□□
JBXX LLBYW	JB:Product Code	
	XX:Output Voltage	
	A: A type	
	LL:LOT NO.	
	B:FAB Code	
YW:Date Code		
Product Classification		BL8071CLBTR□□
JBXX LLBYW	JB:Product Code	
	XX:Output Voltage	
	B: B type	
	LL:LOT NO.	
	B:FAB Code	
YW:Date Code		
VDD	Supply Voltage Input	
GND	Ground Pin	
VOUT	Output Voltage	

ABSOLUTE MAXIMUM RATING

Parameter		Value
Max Input Voltage		8V
Max Operating Junction Temperature (T _J)		145°C
Ambient Temperature (T _A)		-40°C~85°C
Package Thermal Resistance	SOT-223	20°C / W
Storage Temperature (T _S)		-40°C~150°C
Lead Temperature & Time		260°C, 10 Sec

Y: The Year of manufacturing, "1" stands for year 2011, "2" stands for year 2012, and "8" stands for year 2018.
W: The week of manufacturing. "A" stands for week 1, "Z" stands for week 26, "A" stands for week 27, "Z" stands for week 52.

RECOMMENDED WORK CONDITIONS

Parameter	Value
Input Voltage Range	Max. 6V
Ambient Temperature	-40°C~85°C
Operating Junction Temperature (T _J)	125°C

ELECTRICAL CHARACTERISTICS

Test Conditions: $C_{IN}=4.7\mu F, C_{OUT}=4.7\mu F, T_A=25^\circ C$, unless otherwise specified.

Symbol	Parameter	Conditions	Min	Typ	Max	Units
V_{DD}	Input Voltage		1.5*		6	V
V_{OUT}	Output Voltage	$V_{OUT}>1.5$	$V_{DD}=\text{Set } V_{OUT}+1V$ $1mA \leq I_{OUT} \leq 10mA$	V_{OUT}	$V_{OUT} \times 0.98$	V
		$V_{OUT} \leq 1.5$			$V_{OUT} - 0.03$	
$I_{OUT} (\text{Max.})^{**}$	Maximum Output Current	$V_{DD}-V_{OUT}=1V$	1.5			A
V_{DROP}	Dropout Voltage	$V_{OUT}=3.3V, I_{OUT}=1A$		300	500	mV
$\frac{\Delta V_{out}}{\Delta V_{in} \cdot V_{out}}$	Line Regulation	$I_{OUT}=10mA, 4V \leq V_{DD} \leq 6V$		0.05	0.2	%/V
ΔV_{out}	Load Regulation	$V_{DD}=\text{Set } V_{OUT}+1V$ $1mA \leq I_{OUT} \leq 2.5A$		30	60	mV
I_s	Supply Current	$V_{DD}=\text{Set } V_{OUT}+1V, V_{OUT}$ Floating		100	150	μA
$\frac{\Delta V_{out}}{\Delta T \cdot V_{out}}$	Output Voltage Temperature Coefficient	$I_{OUT}=10mA$		± 100		ppm/ $^\circ C$
PSRR	Ripple Rejection	$f=100Hz, \text{Ripple}=0.5Vp-p,$ $V_{DD}=\text{Set } V_{OUT}+1V$		70		dB
en	Output Noise	$BW=10Hz \sim 100KHz$		44		μV_{rms}

Note: * $I_{out}=500mA @ V_{out}=1.2V$

**The maximum power rating of each package is a constant, so along with the change of I_{LOAD} , the $V_{DD}-V_{OUT}$ should be controlled to a certain range to ensure the normal operation.

THERMAL CONSIDERATIONS

We have to take heat dissipation into great consideration when output current or differential voltage of input and output voltage is large. Because in such cases, the power dissipation consumed by BL8071 is very large. BL8071 series uses SOT-223 package type and its thermal resistance is about $20^\circ C/W$. And the copper area of application board can affect the total thermal resistance. If copper area is $5cm \times 5cm$ (two sides), the resistance is about $30^\circ C/W$. So the total thermal resistance is about $20^\circ C/W + 30^\circ C/W$. In this case, the power dissipation should be limited less than 1.2W. We can decrease total thermal resistance by increasing copper area in application board. When there is no good heat dissipation copper are in PCB, the total thermal resistance will be as high as $120^\circ C/W$, then the power dissipation of BL8071 could allow on itself is less than 1W. And furthermore, BL8071 will work at junction temperature higher than $125^\circ C$ under such condition and no lifetime is guaranteed.

CURRENT LIMIT MODE

Current Limit module can keep chip and power system away from danger when load current is too large. When V_{out} decrease the Short Circuit Current will fold back to a small value.

TYPICAL PERFORMANCE CHARACTERISTICS

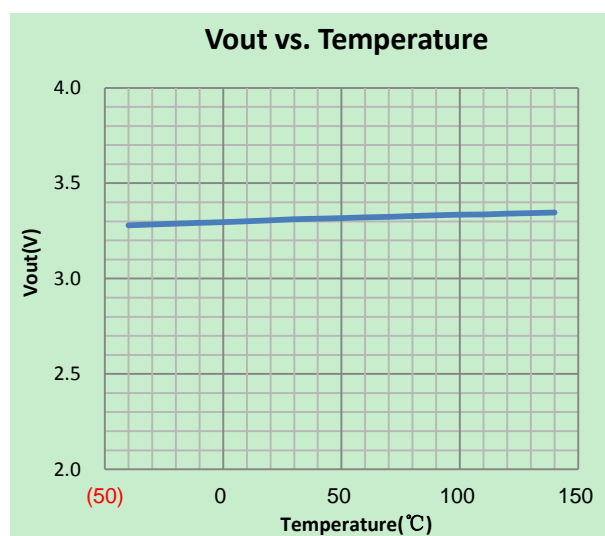
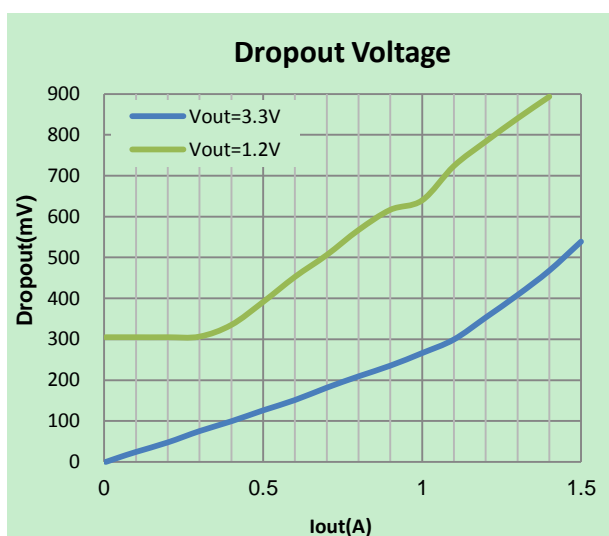
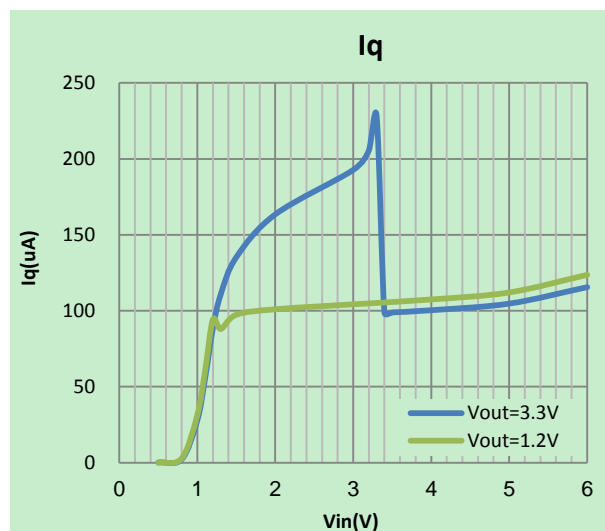
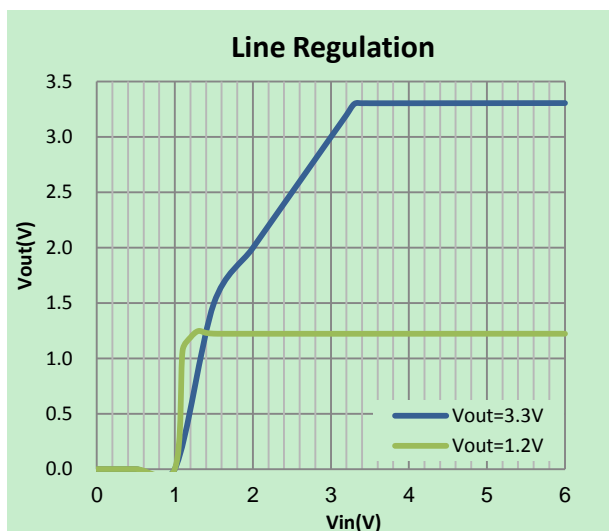
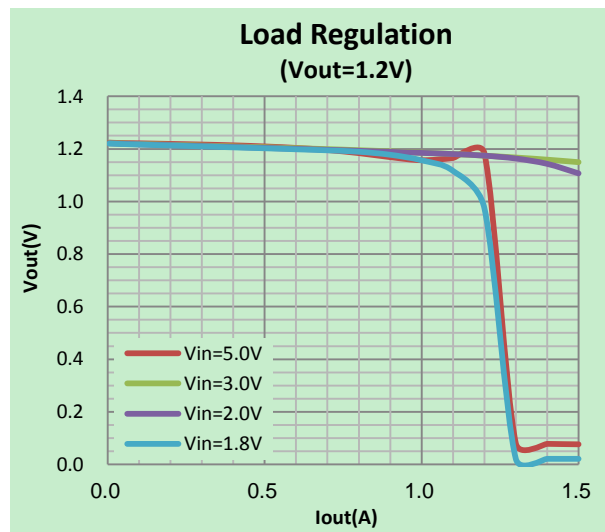
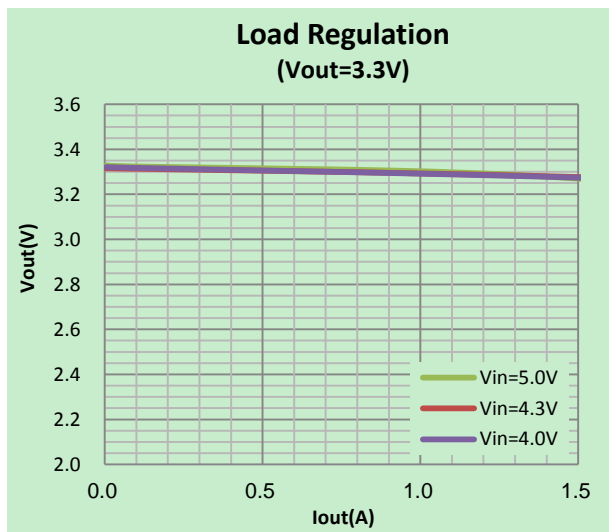

Load Transient Response (Vin=5V, Vout=3.3V) Cin=1uF, Cout=1uF, Iout=1mA-100mA

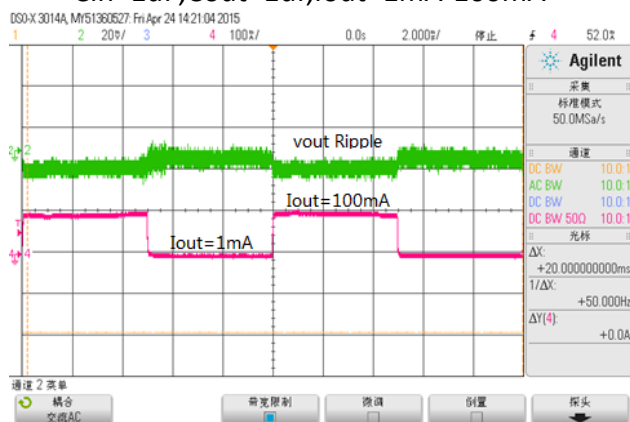

Line Transient Response (Vin=5V, Vout=3.3V) Cin=1uF, Cout=1uF, Iout=10mA, Vin=4.3V-5.3V

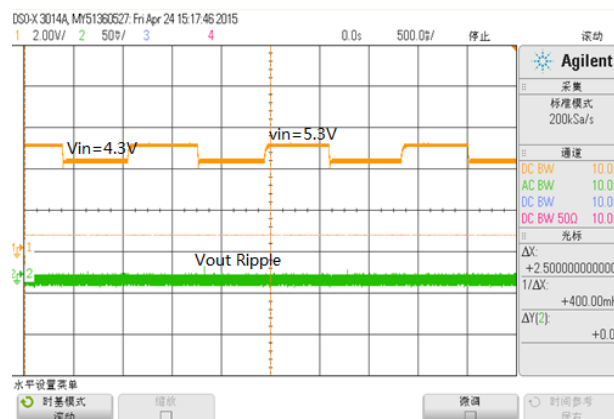

PACKAGE LINE

Package	SOT-223	Devices per reel	2500Pcs	Unit	mm																																																																																																								
Package specification:																																																																																																													
			<p>COMMON DIMENSIONS (UNITS OF MEASURE=MILLIMETER)</p> <table border="1"> <thead> <tr> <th>SYMBOL</th> <th>MIN</th> <th>NOM</th> <th>MAX</th> </tr> </thead> <tbody> <tr><td>A</td><td>-</td><td>-</td><td>1.80</td></tr> <tr><td>A1</td><td>0.02</td><td>-</td><td>0.10</td></tr> <tr><td>A2</td><td>1.50</td><td>1.60</td><td>1.70</td></tr> <tr><td>A3</td><td>0.80</td><td>0.90</td><td>1.00</td></tr> <tr><td>b</td><td>0.67</td><td>-</td><td>0.80</td></tr> <tr><td>b1</td><td>0.66</td><td>0.71</td><td>0.76</td></tr> <tr><td>b2</td><td>2.96</td><td>-</td><td>3.09</td></tr> <tr><td>b3</td><td>2.95</td><td>3.00</td><td>3.05</td></tr> <tr><td>c</td><td>0.30</td><td>-</td><td>0.35</td></tr> <tr><td>c1</td><td>0.29</td><td>0.30</td><td>0.31</td></tr> <tr><td>D</td><td>6.48</td><td>6.53</td><td>6.58</td></tr> <tr><td>D1</td><td>6.55</td><td>6.60</td><td>6.65</td></tr> <tr><td>D2</td><td>-</td><td>-</td><td>7.05</td></tr> <tr><td>E</td><td>6.80</td><td>-</td><td>7.20</td></tr> <tr><td>E1</td><td>3.40</td><td>3.50</td><td>3.60</td></tr> <tr><td>E2</td><td>3.33</td><td>3.43</td><td>3.53</td></tr> <tr><td>e</td><td colspan="3">2.30BSC</td></tr> <tr><td>e1</td><td colspan="3">4.60BSC</td></tr> <tr><td>L</td><td>0.80</td><td>1.00</td><td>1.20</td></tr> <tr><td>L1</td><td colspan="3">1.75REF</td></tr> <tr><td>L2</td><td colspan="3">0.25BSC</td></tr> <tr><td>R</td><td>0.10</td><td>-</td><td>-</td></tr> <tr><td>R1</td><td>0.10</td><td>-</td><td>-</td></tr> <tr><td>theta</td><td>0°</td><td>-</td><td>8°</td></tr> <tr><td>theta 1</td><td>10°</td><td>12°</td><td>14°</td></tr> </tbody> </table> <p>NOTES: ALL DIMENSIONS REFER TO JEDEC STANDARD TO261-AA</p>			SYMBOL	MIN	NOM	MAX	A	-	-	1.80	A1	0.02	-	0.10	A2	1.50	1.60	1.70	A3	0.80	0.90	1.00	b	0.67	-	0.80	b1	0.66	0.71	0.76	b2	2.96	-	3.09	b3	2.95	3.00	3.05	c	0.30	-	0.35	c1	0.29	0.30	0.31	D	6.48	6.53	6.58	D1	6.55	6.60	6.65	D2	-	-	7.05	E	6.80	-	7.20	E1	3.40	3.50	3.60	E2	3.33	3.43	3.53	e	2.30BSC			e1	4.60BSC			L	0.80	1.00	1.20	L1	1.75REF			L2	0.25BSC			R	0.10	-	-	R1	0.10	-	-	theta	0°	-	8°	theta 1	10°	12°	14°
SYMBOL	MIN	NOM	MAX																																																																																																										
A	-	-	1.80																																																																																																										
A1	0.02	-	0.10																																																																																																										
A2	1.50	1.60	1.70																																																																																																										
A3	0.80	0.90	1.00																																																																																																										
b	0.67	-	0.80																																																																																																										
b1	0.66	0.71	0.76																																																																																																										
b2	2.96	-	3.09																																																																																																										
b3	2.95	3.00	3.05																																																																																																										
c	0.30	-	0.35																																																																																																										
c1	0.29	0.30	0.31																																																																																																										
D	6.48	6.53	6.58																																																																																																										
D1	6.55	6.60	6.65																																																																																																										
D2	-	-	7.05																																																																																																										
E	6.80	-	7.20																																																																																																										
E1	3.40	3.50	3.60																																																																																																										
E2	3.33	3.43	3.53																																																																																																										
e	2.30BSC																																																																																																												
e1	4.60BSC																																																																																																												
L	0.80	1.00	1.20																																																																																																										
L1	1.75REF																																																																																																												
L2	0.25BSC																																																																																																												
R	0.10	-	-																																																																																																										
R1	0.10	-	-																																																																																																										
theta	0°	-	8°																																																																																																										
theta 1	10°	12°	14°																																																																																																										

单击下面可查看定价，库存，交付和生命周期等信息

[>>BELLING\(上海贝岭\)](#)