

**Gas Discharge Tube
Features**

- Small Size Design 5.5×4.0×4.0mm
- Current Handling Capability 5,000A @ 8/20μs
- Low Capacitance and Insertion Loss
- Fast Response and Long Service Life
- Moisture sensitivity level: Level 1

Application information

- RS485/232/422

Agency Approvals

Icon	Description
RoHS	Compliance with 2011/65/EU
HF	Compliance with IEC61249-2-21:2003
	Mean lead free

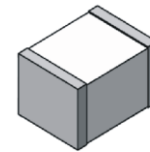
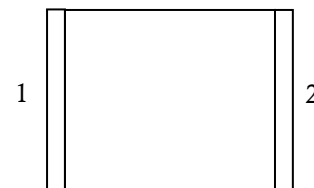
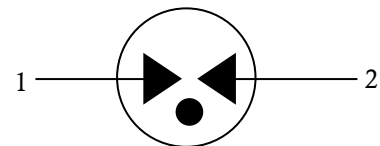
Exterior

SMD
Package (Top View)

Schematic Symbol

Electrical Parameter

DC Breakdown Voltage 1)2)	100V/s	72~108	V
Impulse Spark-over Voltage	At 1kV/μs	for 99 % of measured values	≤ 600
	At 1kV/μs	Typical values of distribution	≤550
Impulse Discharge Current 3)	8/20μs 10 operations [5x (+) & 5x (-)]	5,000	A
Arc Voltage	At 1A	~15	V
Insulation Resistance	DC=50V	≥1	GΩ
Capacitance at 1MHz	VDC=0.5V	≤0.6	pF
Weight		~0.43	g
Operating And Storage Temperature		-40-125	°C
Marking		Without	

1) At delivery AQL 0.65 level II ISO 2859

2) In ionized mode

3) Terms and waveforms in accordance with ITU-T Rec. K. 12; IEC 61643-21

Gas Discharge Tube

Version: A0 2020-06-22

Part Numbering System

BN 091 M

(1) (2) (3)

(1)Bencent Gas Discharge Tube

(2) Series: DC Breakdown Voltage,

 e.g.: 091=9×10¹=90V

 (3) Tolerance of DC Breakdown Voltage, M=+-20%,
 N=+-30%,the Specific tolerance is decided by the table
 of “Electrical Parameter”

Product Characteristics

Lead Material	Copper or iron nickel alloy
Body Material	Ceramics
Terminal Finish	100% Matte-Tin Plated

Environmental Reliability Characteristics

Testing items	Technical standards
High Temperature Storage Test	Temperature: 125°C Time:2H
Low Temperature Storage Test	Temperature: -40°C Time:2H
Vibration	Frequency: 10-500Hz Amplitude: 0.15mm Time: 45min
Resistance of soldering heat	Temperature: 260±5°C Time of dip soldering: 10s, 1time

Note: Up-screen program can be specified by customer's request via contacting Bencent service

Solderability test

Solderability	Solder Pot Temperature:	245°C ± 5°C
	Solder Dwell Time:	4-6 seconds

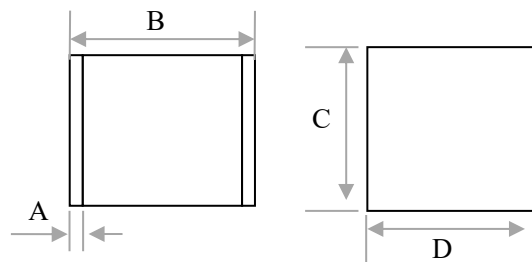
Product Dimensions

REF	mm	inch
A	0.45±0.1	0.018±0.004
B	5.5±0.2	0.216±0.008
C	4.0±0.2	0.157±0.008
D	4.0±0.2	0.157±0.008

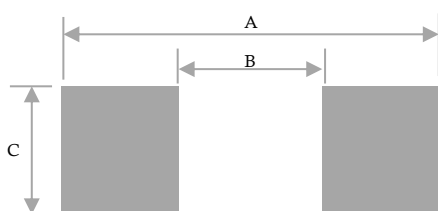
Recommended Soldering Pad

REF	mm	inch
A	6.1	0.240
B	4.4	0.161
C	4.2	0.165

Reflow Profile

Reflow Condition		Pb-Free assembly
Pre Heat	Temperature Min	150°C
	Temperature Max	200°C
	Time (min to max)	60 – 180 secs
Average ramp up rate (Liquids) T _{amp} (T _L) to peak		3°C/second max
T _{S(max)} to T _L - Ramp-up Rate		3°C/second max
Reflow	- Temperature (T _L) (Liquids)	217°C
	- Temperature (T _L)	60 – 150 seconds
Peak Temperature (T _P)		260±0/-5 °C
Time within 5°C of actual peak Temperature (t _p)		~10 seconds
Ramp-down Rate		6°C/second max
Time 25°C to peak Temperature (T _P)		8 minutes Max.
Do not exceed		260°C

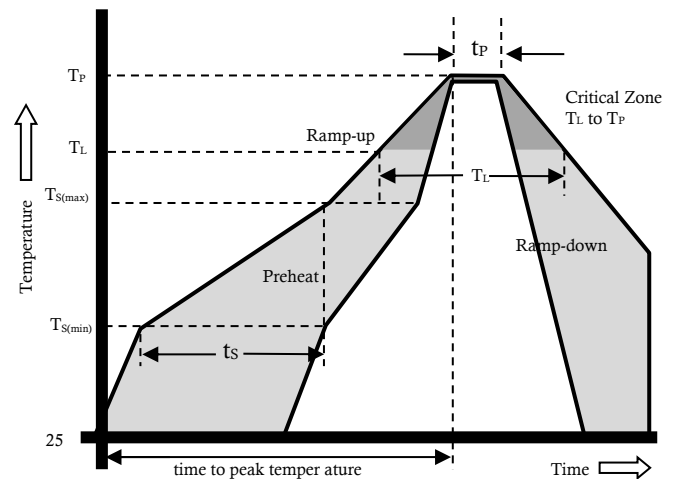
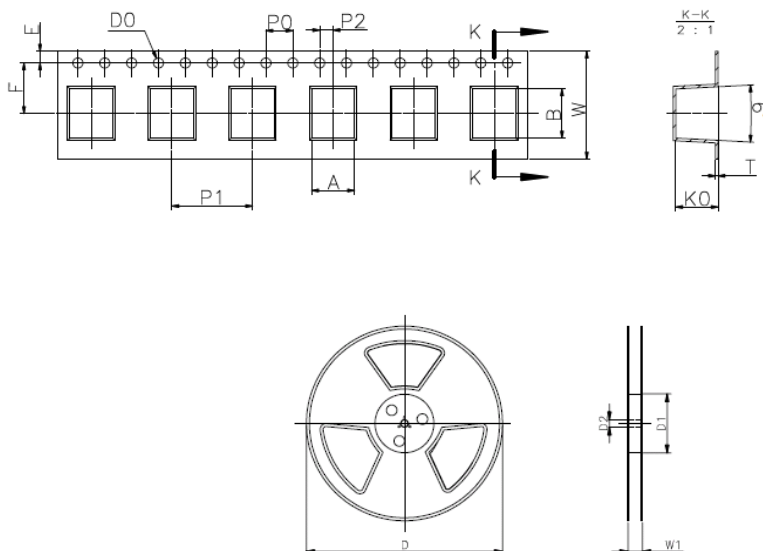
Package Reel Information

REF	mm	inch
A	4.3±0.1	0.169±0.004
B	5.8±0.1	0.228±0.004
D ₀	1.5±0.2	0.059±0.008
E	1.75±0.2	0.069±0.008
F	7.5±0.2	0.295±0.008
P ₀	4±0.2	0.157±0.008
P ₁	8±0.5	0.472±0.020
P ₂	2±0.2	0.079±0.008
W	16±0.5	0.630±0.020
K ₀	4.3±0.1	0.169±0.004
T	0.4±0.05	0.016±0.002
D	Φ330±2	Φ12.99±0.079
D ₁	Φ100 ⁺¹ ₋₂	Φ3.94 ^{+0.039} _{-0.078}
D ₂	Φ13±0.15	0.512±0.006
W ₁	20±1	0.787±0.039

Package Box Information

Outline	Reel (PCS)	Per Carton (PCS)	Carton Size(mm)		
			L	W	H
Box	1600	25600	360	360	380

单击下面可查看定价，库存，交付和生命周期等信息

[>>Bencent \(槟城\)](#)