

Revision History

Version	Revision Description	Department	Owner	Date
A0	First edition	R&D	Ran xian fa	2021-11-15
A1	Add Recommended mcov voltage ,Add capacitance reference value and Modify package quantity.	R&D	Ran xian fa	2022-2-9
A2	Adjust the dynamic error coefficient and increase the error \pm sign.	R&D	Ran xian fa	2022-2-21

Issued by		Checked by	<i>RD</i>	Approval	
			<i>QA</i>		
			<i>MD</i>		





Features

- Wide Maximum Allowable Voltage from(Recommended MCOV) 55V to 560V
- Fast responding to transient over-voltage
- Large absorbing transient energy capability
- Low clamping ratio and no follow-on current
- Moisture sensitivity level: Level 1
- Operating Temperature:-40°C~+105°C
- Storage Temperature:-40°C~+105°C

Application information

- AC Power
- Surge protection in consumer electronics
- Surge protection in industrial electronics
- Surge protection in electronic home appliances, gas and petroleum appliances
- Relay and electromagnetic valve surge absorption

Agency Approvals

Icon	Description
	Compliance with 2011/65/EU
	Compliance with IEC61249-2-21:2003
	Mean lead free
	Compliance with UL1449, Certificated E337906

Electrical Characteristics

Part No	UL	Recommended	UL	Split Components Parameters		Platform voltage	Peak voltage	Withstanding Surge Current		Maximum Energy (J)	Typical Capacitance (Reference) @1KHz (pf)
	VOLTS	MCOV	MCOV	MOV Voltage	GDT Voltage			8/20µs 5kA (Time)	1.2/50-8/20µs 10kV-5kA (Time)		
	V _{AC} (V)	V _{AC} (V)	V _{AC} (V)	V _{1mA} (V)	V _{100V/s} (V)	V _{1000V/us} (V)	V _{1000V/us} (V)				
BMG20D820K091Y	52	55	70	82(74~90)	90(72~108)	≤150	≤710	20	40	56.0	5
BMG20D820K351Y	52	60	70	82(74~90)	350(280~420)	≤150	≤1020	20	40	56.0	5
BMG20D101K091Y	65	70	85	100(90~110)	90(72~108)	≤180	≤710	20	40	70.0	5
BMG20D101K351Y	65	75	85	100(90~110)	350(280~420)	≤180	≤1020	20	40	70.0	5
BMG20D121K091Y	75	80	100	120(108~132)	90(72~108)	≤210	≤710	20	40	85.0	5
BMG20D121K351Y	75	90	100	120(108~132)	350(280~420)	≤210	≤1020	20	40	85.0	5
BMG20D151K091Y	95	100	120	150(135~165)	90(72~108)	≤270	≤708	20	40	106.0	5
BMG20D151K351Y	95	115	120	150(135~165)	350(280~420)	≤270	≤1020	20	40	106.0	5
BMG20D181K091Y	115	120	150	180(162~198)	90(72~108)	≤320	≤710	20	40	130.0	5
BMG20D181K351Y	115	135	150	180(162~198)	350(280~420)	≤320	≤1020	20	40	130.0	5

Exterior

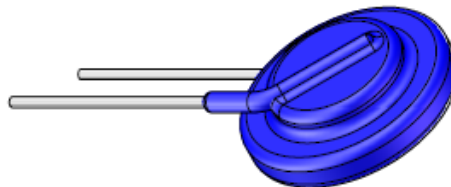

Package (Top View)

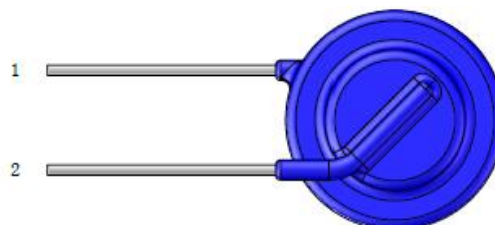

Schematic Symbol

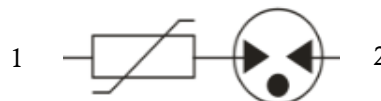

Part No	UL	Recommended	UL	Split Components Parameters		Platform voltage	Peak voltage	Withstanding Surge Current		Maximum Energy	Typical Capacitance (Reference)
	VOLTS	MCOV	MCOV	MOV Voltage	GDT Voltage			8/20µs 5kA (Time)	1.2/50-8/20µs 10kV-5kA (Time)		
	V _{AC} (V)	V _{AC} (V)	V _{AC} (V)	V _{1mA} (V)	V _{100V/s} (V)	V _{1000V/us} (V)	V _{1000V/us} (V)				
BMG20D201K091Y	130	140	170	200(180-220)	90(72-108)	≤350	≤710	20	40	140	5
BMG20D201K351Y	130	145	170	200(180-220)	350(280-420)	≤350	≤1020	20	40	140	5
BMG20D221K351Y	140	150	185	220(198-242)	350(280-420)	≤390	≤1020	20	40	155.0	5
BMG20D221K601Y	140	170	185	220(198-242)	600(480-720)	≤390	≤1320	20	40	155.0	5
BMG20D241K351Y	150	160	200	240(216-264)	350(280-420)	≤430	≤1020	20	40	168.0	5
BMG20D241K601Y	150	180	200	240(216-264)	600(480-720)	≤430	≤1320	20	40	168.0	5
BMG20D271K351Y	175	190	230	270(243-297)	350(280-420)	≤480	≤1020	20	40	190.0	5
BMG20D271K601Y	175	210	230	270(243-297)	600(480-720)	≤480	≤1320	20	40	190.0	5
BMG20D301K351Y	190	200	250	300(270-330)	350(280-420)	≤530	≤1020	20	40	210.0	5
BMG20D301K601Y	190	230	250	300(270-330)	600(480-720)	≤530	≤1320	20	40	210.0	5
BMG20D331K351Y	210	220	280	330(297-363)	350(280-420)	≤580	≤1020	20	40	228.0	5
BMG20D331K601Y	210	250	280	330(297-363)	600(480-720)	≤580	≤1320	20	40	228.0	5
BMG20D361K351Y	230	240	300	360(324-396)	350(280-420)	≤640	≤1020	20	40	255.0	5
BMG20D361K601Y	230	270	300	360(324-396)	600(480-720)	≤640	≤1320	20	40	255.0	5
BMG20D391K351Y	250	260	330	390(351-429)	350(280-420)	≤690	≤1020	20	40	275.0	5
BMG20D391K102Y	250	310	330	390(351-429)	1000(800-1200)	≤690	≤1800	20	40	275.0	5
BMG20D431K601Y	275	300	360	430(387-473)	600(480-720)	≤760	≤1320	20	40	305.0	5
BMG20D431K102Y	275	330	360	430(387-473)	1000(800-1200)	≤760	≤1800	20	40	305.0	5
BMG20D471K601Y	300	320	390	470(423-517)	600(480-720)	≤830	≤1320	20	40	350.0	5
BMG20D471K102Y	300	360	390	470(423-517)	1000(800-1200)	≤830	≤1800	20	40	350.0	5
BMG20D511K601Y	320	340	420	510(459-561)	600(480-720)	≤986	≤1320	20	40	360.0	5
BMG20D511K102Y	320	390	420	510(459-561)	1000(800-1200)	≤900	≤1800	20	40	360.0	5
BMG20D561K601Y	350	370	460	560(504-616)	600(480-720)	≤986	≤1320	20	40	380.0	5
BMG20D561K102Y	350	420	460	560(504-616)	1000(800-1200)	≤990	≤1800	20	40	380.0	5
BMG20D621K601Y	385	400	510	620(558-682)	600(480-720)	≤1100	≤1320	20	40	390.0	5
BMG20D621K102Y	385	460	510	620(558-682)	1000(800-1200)	≤1100	≤1800	20	40	390.0	5
BMG20D681K601Y	420	440	550	680(612-748)	600(480-720)	≤1200	≤1320	20	40	400.0	5
BMG20D681K102Y	420	520	550	680(612-748)	1000(800-1200)	≤1200	≤1800	20	40	400.0	5
BMG20D751K601Y	460	480	600	750(675-825)	600(480-720)	≤1320	≤1320	20	40	420.0	5
BMG20D751K102Y	460	560	600	750(675-825)	1000(800-1200)	≤1320	≤1800	20	40	420.0	5

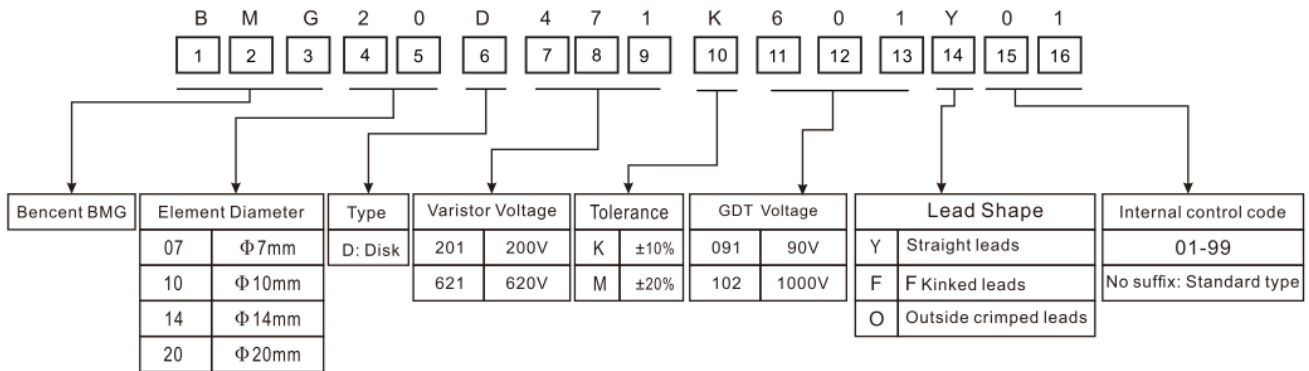
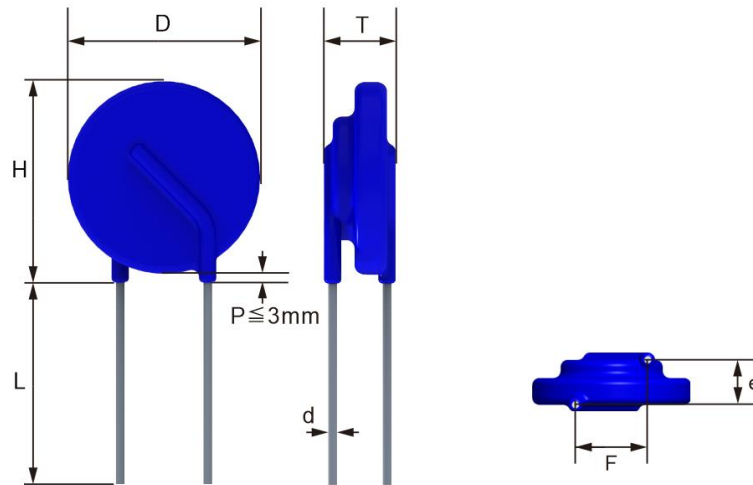
Part Numbering System

Dimensions

Notes: The foot shape can be customized according to customer needs.

Unit: mm

Symbol	Dimension
H(max)	25
L(min)	20
D(max)	23
F	10±1
T	Table 2
e(±1.0)	Table 2
d(±0.05)	1

Unit: mm

Model	T(Max)	e	Model	T(Max)	e
820K	7.50	3.93	331K	8.50	4.83
101K	7.50	4.14	361K	8.50	5.00
121K	7.50	4.36	391K	9.00	5.17
151K	8.00	4.70	431K	9.00	5.39
181K	8.00	4.00	471K	9.00	5.61
201K	8.00	4.11	511K	9.00	5.83
221K	8.00	4.22	561K	9.00	6.11
241K	8.00	4.33	621K	10.00	6.44
271K	8.00	4.50	681K	10.00	6.78
301K	8.50	4.67	751K	10.00	7.17

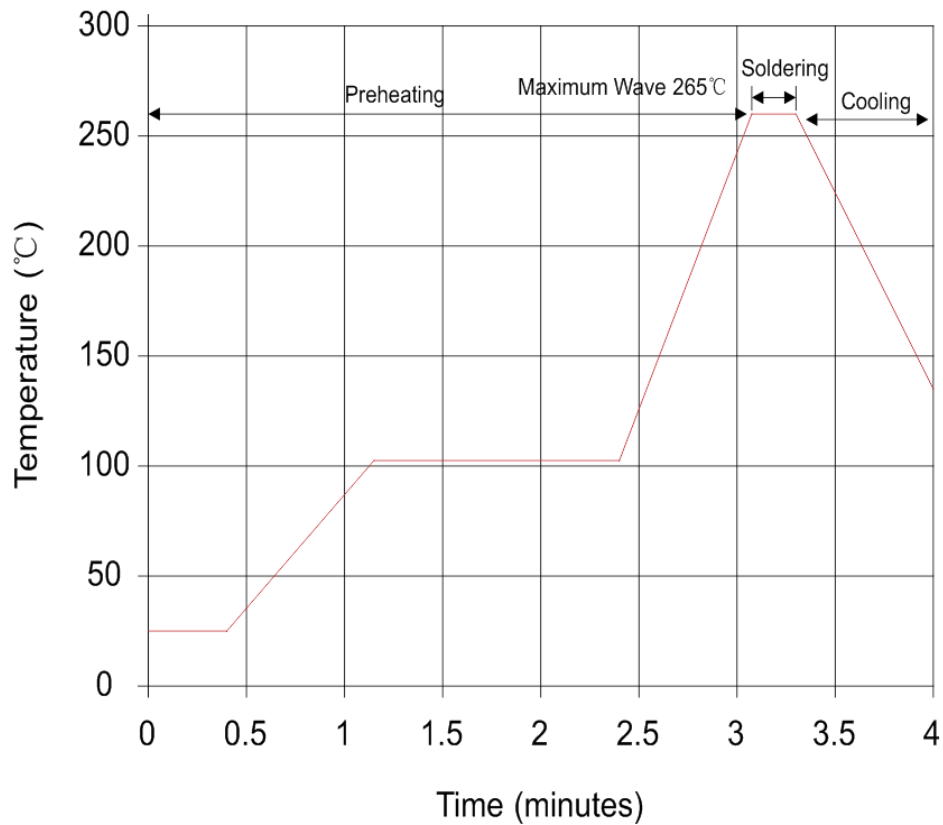
Soldering Recommendation
Lead-free Wave Soldering Recommendation

Item	Conditions
Peak Temperature	265°C
Dipping Time	10 seconds (max)
Soldering	1 time

Recommendation Reworking Conditions with Soldering Iron

Item	Conditions
Temperature of Soldering Iron-tip	360°C
Soldering Time	3 seconds (max)
Distance from Varistor	2mm (min)

Mechanical Characteristics

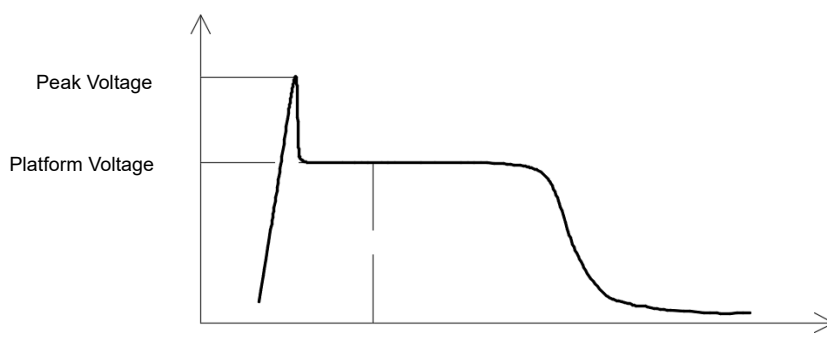
Items	Test conditions / Methods	Specifications								
1000V/us Wave chart		Impulse Voltage Wave								
Tensile Strength of Terminals	Gradually applying the force specified and keeping the unit fixed for 10±1 sec <table border="1" data-bbox="319 828 1117 1030"> <thead> <tr> <th>Terminal diameter (mm)</th> <th>Force (kg)</th> </tr> </thead> <tbody> <tr> <td>0.5 < d ≤ 0.8</td> <td>1.0</td> </tr> <tr> <td>0.8 < d ≤ 1.25</td> <td>2.0</td> </tr> <tr> <td>1.25 < d</td> <td>4.0</td> </tr> </tbody> </table>	Terminal diameter (mm)	Force (kg)	0.5 < d ≤ 0.8	1.0	0.8 < d ≤ 1.25	2.0	1.25 < d	4.0	No visible damage Peak voltage ΔV1000V/us/V1000V/us ≤±20% Platform voltage ΔV1000V/us/V1000V/us ≤±10%
Terminal diameter (mm)	Force (kg)									
0.5 < d ≤ 0.8	1.0									
0.8 < d ≤ 1.25	2.0									
1.25 < d	4.0									
Bending Strength of Terminals	Hold specimen and apply the force specified below to each lead. Bend the specimen to 90°, then return to the original position. Repeat the procedure in the opposite direction. <table border="1" data-bbox="319 1164 1117 1366"> <thead> <tr> <th>Terminal diameter (mm)</th> <th>Force (kg)</th> </tr> </thead> <tbody> <tr> <td>0.5 < d ≤ 0.8</td> <td>0.5</td> </tr> <tr> <td>0.8 < d ≤ 1.25</td> <td>1.0</td> </tr> <tr> <td>1.25 < d</td> <td>2.0</td> </tr> </tbody> </table>	Terminal diameter (mm)	Force (kg)	0.5 < d ≤ 0.8	0.5	0.8 < d ≤ 1.25	1.0	1.25 < d	2.0	No visible damage Peak voltage ΔV1000V/us/V1000V/us ≤±20% Platform voltage ΔV1000V/us/V1000V/us ≤±10%
Terminal diameter (mm)	Force (kg)									
0.5 < d ≤ 0.8	0.5									
0.8 < d ≤ 1.25	1.0									
1.25 < d	2.0									
Vibration	Frequency range: 10~55 Hz Amplitude: 0.75mm or 98m/s ² Direction: 3 mutually perpendicular directions, 2hrs each.	No visible damage Peak voltage ΔV1000V/us/V1000V/us ≤±20% Platform voltage ΔV1000V/us/V1000V/us ≤±10%								
Solder ability	Solder Temp: 245±5°C Dipping Time: 2±0.5 sec	Atleast 95% of terminal electrode is covered by new solder								
Resistance to Soldering Heat	Solder Temp: 260±5°C Dipping Time: 10±1 sec	No visible damage Peak voltage ΔV1000V/us/V1000V/us ≤±20% Platform voltage ΔV1000V/us/V1000V/us ≤±10%								

Reliability

Items	Test conditions / Methods	Specifications															
High Temperature Storage	Ambient Temp: 105±2°C Duration: 1000hrs	No visible damage Peak voltage ΔV1000V/us/V1000V/us ≤±20% Platform voltage ΔV1000V/us/V1000V/us ≤±10%															
Low Temperature Storage	Ambient Temp: -40±2°C Duration: 1000hrs	No visible damage Peak voltage ΔV1000V/us/V1000V/us ≤±20% Platform voltage ΔV1000V/us/V1000V/us ≤±10%															
Humidity	Ambient Temp: 40±2°C, 90~95% R.H. Duration: 1000hrs	No visible damage Peak voltage ΔV1000V/us/V1000V/us ≤±20% Platform voltage ΔV1000V/us/V1000V/us ≤±10%															
Temperature Cycle	The conditions shown below shall be repeated 5 cycles <table border="1" style="margin-left: 20px;"> <thead> <tr> <th>Step</th> <th>Temperature (°C)</th> <th>Period (minutes)</th> </tr> </thead> <tbody> <tr> <td>1</td> <td>-40±3</td> <td>30±3</td> </tr> <tr> <td>2</td> <td>Room temperature</td> <td>15±3</td> </tr> <tr> <td>3</td> <td>105±3</td> <td>30±3</td> </tr> <tr> <td>4</td> <td>Room temperature</td> <td>15±3</td> </tr> </tbody> </table>	Step	Temperature (°C)	Period (minutes)	1	-40±3	30±3	2	Room temperature	15±3	3	105±3	30±3	4	Room temperature	15±3	No visible damage Peak voltage ΔV1000V/us/V1000V/us ≤±20% Platform voltage ΔV1000V/us/V1000V/us ≤±10%
Step	Temperature (°C)	Period (minutes)															
1	-40±3	30±3															
2	Room temperature	15±3															
3	105±3	30±3															
4	Room temperature	15±3															
High Temperature Load	Ambient Temp: 105±2°C Duration: 1000hrs Load: Max. Allowable Voltage In AC eara.	No visible damage Peak voltage ΔV1000V/us/V1000V/us ≤±20% Platform voltage ΔV1000V/us/V1000V/us ≤±10%															
Damp Heat Load	Ambient Temp: 40±2°C, 90~95% R.H. Duration: 1000hrs Load: Max. Allowable Voltage	No visible damage Peak voltage ΔV1000V/us/V1000V/us ≤±20% Platform voltage ΔV1000V/us/V1000V/us ≤±10%															
Voltage Proof	Metal balls method, 1000Vac 1 min.(820K~331K), 1500Vac 1 min.(361K~751K)	No visible damage															

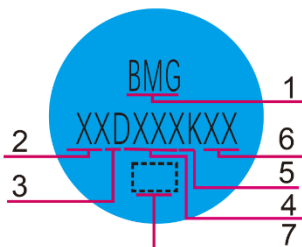
Marking Code

1. BMG:Bencent MOV+GDT
2. XX:Disk size 07、 10、 14、 20
3. D: Disk
4. XXX: Varistor Voltage
5. K: Tolerance, $k=\pm 10$
6. XX:Special Code
7. UL Mark

Quantity

Packaging Dimensions (Unit: mm)

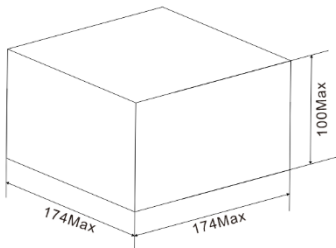
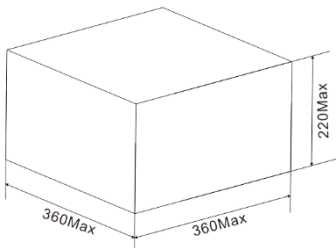
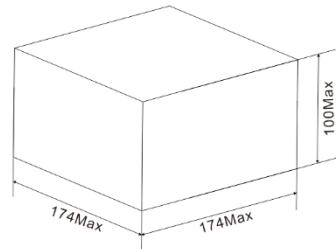
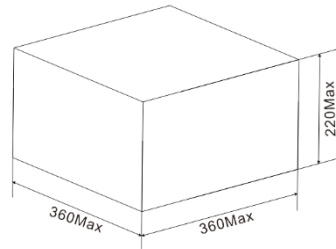
	Inner box size	Outer box size	Quantity
Bulk			150pcs/bag 2bags/box 8Inner Box/Per Carton (820K~391K)
Bulk			100pcs/bag 2bags/box 8Inner Box/Per Carton (431K~751K)

单击下面可查看定价，库存，交付和生命周期等信息

[>>Bencent \(槟城\)](#)