

**Features**

- Small Size Design 4.2×5.0×5.0mm
- Current Handling Capability 5,000A @ 8/20 μ s
- Low Capacitance and Insertion Loss
- Fast Response and Long Service Life
- Moisture sensitivity level: Level 1



**Exterior**

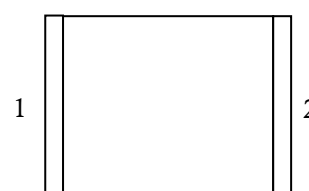

SMD

**Application information**

- RS485/232/422

**Package (Top View)**

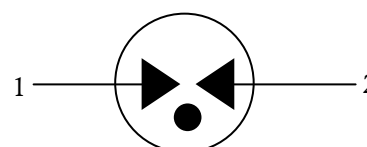
**Agency Approvals**

Icon	Description
<b>RoHS</b>	Compliance with 2011/65/EU
<b>HF</b>	Compliance with IEC61249-2-21:2003
	Mean lead free
	UL Certificated E232249

**Schematic Symbol**

**Electrical Parameter**

DC Breakdown Voltage 1)2)	100V/s	72-108	V
Impulse Spark-over Voltage	At 1kV/μs	for 99 % of measured values	≤ 650
	At 1kV/μs	Typical values of distribution	≤ 600
Impulse Discharge Current 3)	8/20μs, ± 5times	5,000	A
AC Discharge Current	50Hz, 1S, 10times	10	A
Arc Voltage	At 1A	~8	V
Insulation Resistance	DC=50V	≥1	GΩ
Capacitance at 1MHz	VDC=0.5V	≤0.8	pF
Weight		~0.5	g
Operating And Storage Temperature		-40-90	°C
Marking		Without	

1) At delivery AQL 0.65 level II ISO 2859

2) In ionized mode

3) Terms and waveforms in accordance with ITU-T Rec. K. 12; IEC 61643-21

**Part Numbering System**

BF 091 M

(1) (2) (3)

(1) Bencent Gas Discharge Tube

(2) Series: DC Breakdown Voltage,

 e.g.: 091=9×10<sup>1</sup>=90V

 (3) Tolerance of DC Breakdown Voltage, M=+20%,  
 N=+30%, the Specific tolerance is decided by the table  
 of "Electrical Parameter"

**Product Characteristics**

Lead Material	Copper
Body Material	Ceramics
Terminal Finish	100% Matte-Tin Plated

**Environmental Reliability Characteristics**

Testing items	Technical standards
High Temperature Storage Test	Temperature: 90°C Time: 2H
Low Temperature Storage Test	Temperature: -40°C Time: 2H
Vibration	Frequency: 10-500Hz Amplitude: 0.15mm Time: 45min
Resistance of soldering heat	Temperature: 260±5°C Time of dip soldering: 10s, 1time

Note: Up-screen program can be specified by customer's request via contacting Bencent service

**Solderability test**

Solderability	Solder Pot Temperature:	245°C ± 5°C
	Solder Dwell Time:	4-6 seconds

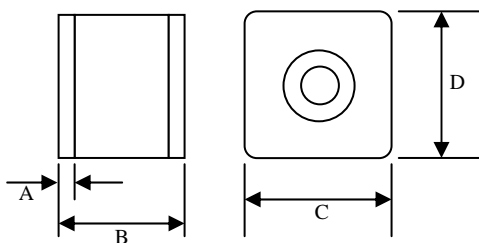
**Product Dimensions**

REF	mm	inch
A	0.5±0.1	0.020±0.004
B	4.2±0.3	0.165±0.012
C	5.0±0.2	0.197±0.008
D	5.0±0.2	0.197±0.008

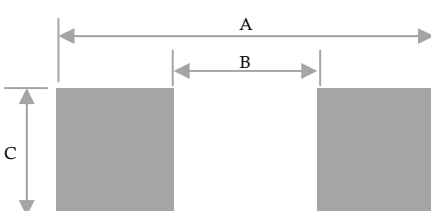
**Recommended Soldering Pad**

REF	mm	inch
A	4.95	0.195
B	3.0	0.118
C	5.5	0.217

**Reflow Profile**

Reflow Condition		Pb-Free assembly
Pre Heat	Temperature Min	150°C
	Temperature Max	200°C
	Time (min to max)	60 – 180 secs
Average ramp up rate (Liquids) T <sub>amp</sub> (T <sub>L</sub> ) to peak		3°C/second max
T <sub>S</sub> (max) to T <sub>L</sub> - Ramp-up Rate		3°C/second max
Reflow	- Temperature (T <sub>L</sub> ) (Liquids)	217°C
	- Temperature (T <sub>L</sub> )	60 – 150 seconds
Peak Temperature (T <sub>P</sub> )		260±0/-5 °C
Time within 5°C of actual peak Temperature (t <sub>p</sub> )		~10 seconds
Ramp-down Rate		6°C/second max
Time 25°C to peak Temperature (T <sub>P</sub> )		8 minutes Max.
Do not exceed		260°C

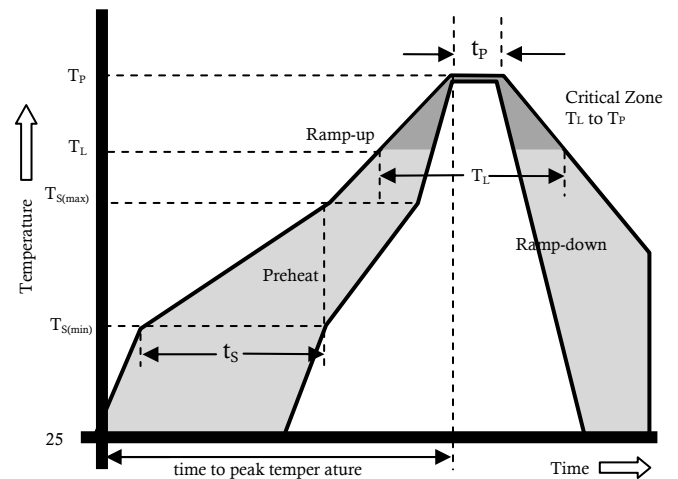
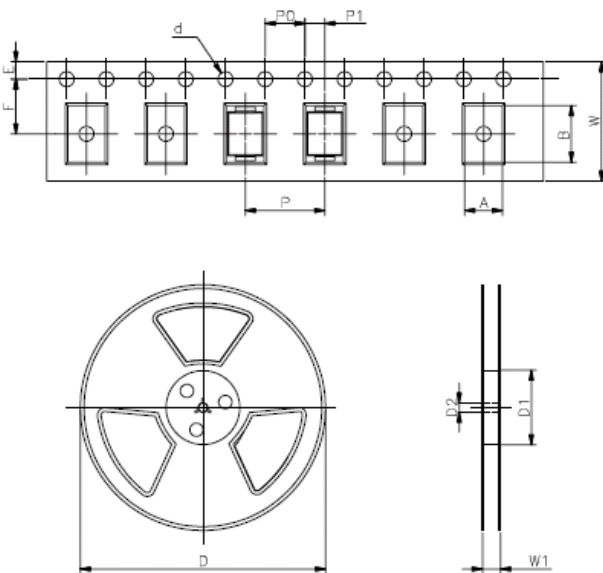
**Package Reel Information**

REF	mm	inch
A	5.3±0.1	0.209±0.004
B	4.5±0.2	0.177±0.008
d	Φ 1.5±0.1	Φ 0.059±0.004
P0	4.0±0.1	0.157±0.004
P1	2.0±0.1	0.079±0.004
P	12.0±0.1	0.472±0.004
E	1.75±0.1	0.069±0.004
F	7.5±0.1	0.295±0.004
W	16.0±0.3	0.630±0.012
D	Φ 330.0	Φ 13.0
D1	Φ 50Min	Φ 1.97Min
D2	Φ 13±0.15	0.512±0.006
W1	16.8±2.0	0.661±0.079

Outline	Reel (PCS)	Per Carton (PCS)	Reel Diameter (mm)	Carton Size(mm)		
				L	W	H
TAPING	1,000	16,000	330	360	360	385

单击下面可查看定价，库存，交付和生命周期等信息

[>>Bencent \(槟城\)](#)