

### Features

- Size Design 5.7×5×5mm
- High Current Handling Capability 3,000 A @ 8/20μs
- Low Capacitance and Insertion Loss
- Fast Response and Long Service Life
- Reliable to Protect Electrostatic Surge
- Moisture sensitivity level: Level 1

### Exterior

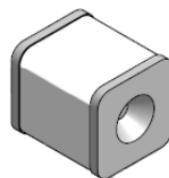

### Application Information

- AC Power

### Package (Top View)

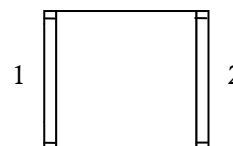

### Agency Approvals

Icon	Description
<b>RoHS</b>	Compliance with 2011/65/EU
<b>HF</b>	Compliance with IEC61249-2-21:2003
	Mean lead free

### Schematic Symbol

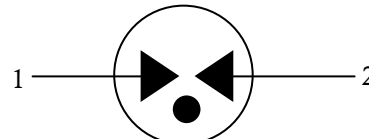

### Electrical Parameter

DC Breakdown Voltage <sup>1) 2)</sup>	100V/s	3000±20%	V
Impulse Spark-over Voltage	1kV/ μ s	≤4000	V
Impulse Discharge Current <sup>3)</sup>	8/20μs ±5 times	3,000	A
Arc Voltage	At 1A	~15	V
Insulation Resistance	DC=100V	≥1	GΩ
Co (1MHz)	V <sub>DC</sub> =0.5V	≤1.5	pF
Weight		~0.65	g
Operating and storage Temperature		-40-90	°C
Marking		Without	

1) At delivery AQL 0.65 level II ISO 2859

2) In ionized mode

3) Terms and current waveforms in accordance with ITU-T Rec. K. 12; IEC 61643-21

## Gas Discharge Tube

Version: A0 2017-03-09

**Part Numbering System**

BW    XXX    M  
 (1)    (2)    (3)

(1) Bencent SMD Gas Discharge Tube in 5.7×5×5 (L×W×H) (mm)

 (2) DC Breakdown Voltage, e.g., 302=30×10<sup>2</sup>=3000V

(3) Tolerance is DC Breakdown Voltage, M=±20%, N=±30%

**Product Characteristics**

Lead Material	Copper
Body Material	Ceramics
Terminal Finish	100% Matte-Tin Plated

**Environmental Reliability Characteristics**

Testing items	Technical standards
High Temperature Storage Test	Temperature: 90°C Time: 2H
Low Temperature Storage Test	Temperature: -40°C Time: 2H
Vibration	Frequency: 10-500Hz Amplitude: 0.15mm Time: 45min
Resistance of soldering heat	Temperature: 260±5°C Time of dip soldering: 10s, 1times

Note: Up-screen program can be specified by customer's request via contacting Bencent service

**Solderability Test**

Solderability	Solder Pot Temperature:	245°C±5°C	Lead-Free Recommendation
	Solder Dwell Time:	4-6 seconds	

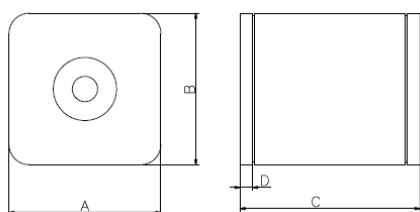
**Product Dimensions**

REF	Mm	inch
A	5±0.2	0.197±0.008
B	5±0.2	0.197±0.008
C	5.7±0.2	0.224±0.008
D	0.5±0.05	0.020±0.002

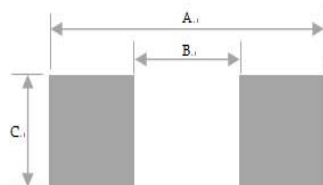
**Recommended Soldering Pad**

REF	Mm	inch
A	6.45	0.254
B	4.5	0.177
C	5.5	0.217

**Reflow Profile**

Reflow Condition		Pb-Free assembly
Pre Heat	Temperature Min	150°C
	Temperature Max	200°C
	Time (min to max)	60 – 180 secs
Average ramp up rate (Liquids)		3°C/second max
Tamp (T <sub>L</sub> ) to peak		3°C/second max
T <sub>S</sub> (max) to T <sub>L</sub> - Ramp-up Rate		3°C/second max
Reflow	- Temperature (T <sub>L</sub> ) (Liquids)	217°C
	- Temperature (T <sub>L</sub> )	60 – 150 seconds
Peak Temperature (T <sub>p</sub> )		260+0/-5 °C
Time within 5°C of actual peak Temperature (t <sub>p</sub> )		20 – 40 seconds
Ramp-down Rate		6°C/second max
Time 25°C to peak Temperature (T <sub>p</sub> )		8 minutes Max.
Do not exceed		260°C

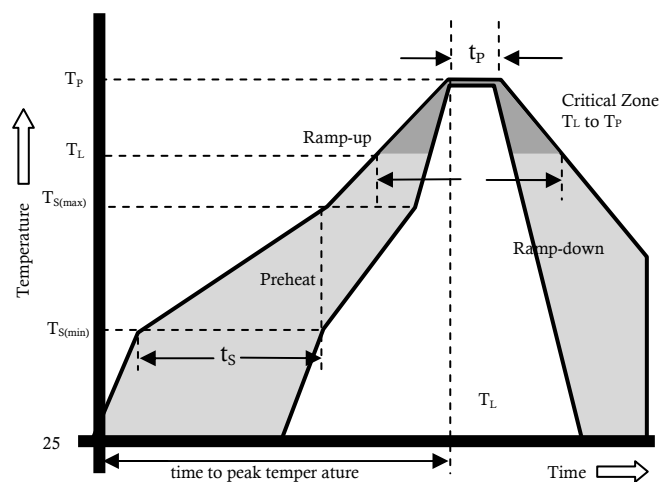
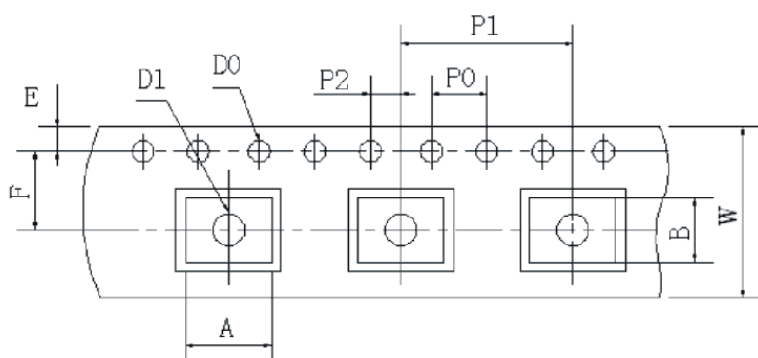
**Package Reel Information**

REF	mm	inch
A	5.5±0.1	0.217±0.004
B	6.2±0.1	0.244±0.004
D0	Φ1.5±0.1	Φ0.059±0.004
E	1.75±0.1	0.069±0.004
F	7.5±0.1	0.295±0.004
P0	4.0±0.1	0.157±0.004
P1	8.0±0.1	0.315±0.004
P2	2.0±0.1	0.079±0.004
W	16±0.3	0.63±0.012

**Package Box Information**

Outline	Reel (PCS)	Per Carton (PCS)	Carton Size(mm)		
			L	W	H
Box	1000	16,000	360	360	360

单击下面可查看定价，库存，交付和生命周期等信息

[>>Bencent \(槟城\)](#)