

Feature

- Resettable over current and over temperature protection
- Small size of 1206
- Fast time-to-trip
- Small footprint
- RoHS complaint
- Low resistance

Application

- Computer
- Battery
- Mobile phones
- Industrial controls
- Automotive
- Portable electronics
- Multimedia
- Game machines
- Telephony and broadband

Part Numbering

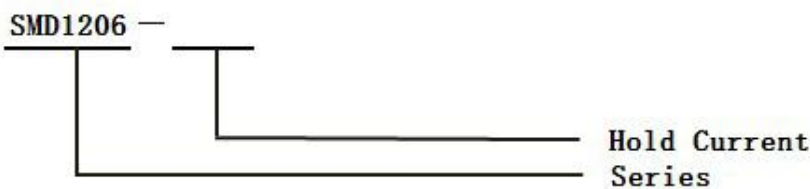

Product Dimensions in Millimeter

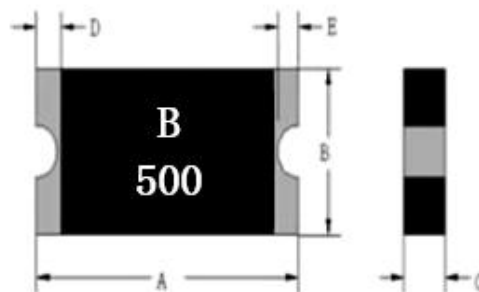

Part Number	A		B		C		D		E	
	Min	Max	Min	Max	Min	Max	Min	Max	Min	Max
SMD1206-500-6V	--	3.50	--	1.85	--	1.2	0.25	--	0.10	--

Electrical Characteristics

Part Number	I(A)		V _{max}	I _{max}	Pd _{typ}	T _{trip}		R _{min}	R _{1max}
	25°C		--	--	--	25°C		25°C	
	Hold	Trip	(V)	(A)	(W)	Current(A)	Time(S)	(Ω)	(Ω)
SMD1206-500-6V	5.00	10.0	6.0	50	1.5	16.0	5.0	0.001	0.012

Surface-Mount Device

SMD1206-500-6V



I_H =Hold current: maximum current at which the device will not trip at 25°C still air reflow soldering of 260°C for 20 sec.
 I_T =Trip current: minimum current at which the device will always trip at 25°C still air reflow soldering of 260°C for 20 sec.

V_{max} =Maximum continuous voltage device can withstand without damage at rated current

I_{max} =Maximum fault current device can withstand without damage at rated voltage.

T_{trip} =Maximum time to trip(s) at assigned current reflow soldering of 260°C for 20 sec.

$P_{d_{typ}}$ =Typical power dissipation: typical amount of power dissipated by the device when in state air environment.

R_{min} = Minimum resistance of device in initial (un-soldered) state.

R_{1max} =Maximum resistance of device at 25°C measured one hour after reflow soldering of 260°C for 20 sec.

Value specified is determined by using the PWB with 0.030" * 1.5oz copper traces.

Caution: Operation beyond the specified rating may result in damage and possible arcing and flame.

Environmental Specifications

Test	Test Conditions	Accept /Reject Criteria
Recommended storage conditions	40°C max, 70% R.H. max	No change
Passive aging:	85°C, 1000 hours	$\leq R_{1max}$
Moisture Resistance	85% RH, 85°C, 1000hrs	$\leq R_{1max}$
Thermal Shock	MIL-STD-202 Method 107G +85°C /-40°C 20 times	$\leq R_{1max}$
Vibration	MIL-STD-883C, Method 2007.1, Condition A	No change
Solvent Resistance	MIL-STD-202, Method 215	No change
Moisture Level Sensitivity	Level 1, J-STD-020C	No change

Thermal Derating [Hold Current (A) at Ambient Temperature (°C)]

Part Number		Maximum Ambient Operating Temperature (°C)							
		-40	-20	0	25	40	50	60	70
SMD1206-500-6V	I_{hold}	7.5	6.5	5.5	5.0	4.5	3.5	3.3	3.0
	I_{trip}	15.0	13.0	11.0	10.0	9.0	7.0	6.6	6.0

Solder Reflow Recommendation

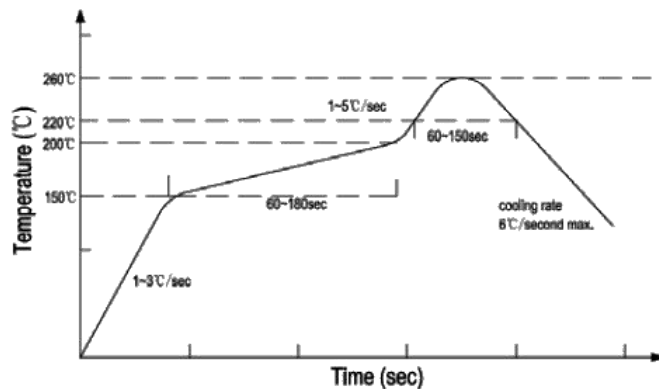

Reflow -curve

Recommended reflow methods: IR, hot air oven, nitrogen oven
 Devices can be cleaned using standard industry methods and solvents.

NOTE:

If reflow temperatures exceed the recommended profile, devices may not meet the performance requirements.

Caution: Operation beyond the rated voltage or current may result in rupture electrical arcing or flame

Average Time-Current Curve

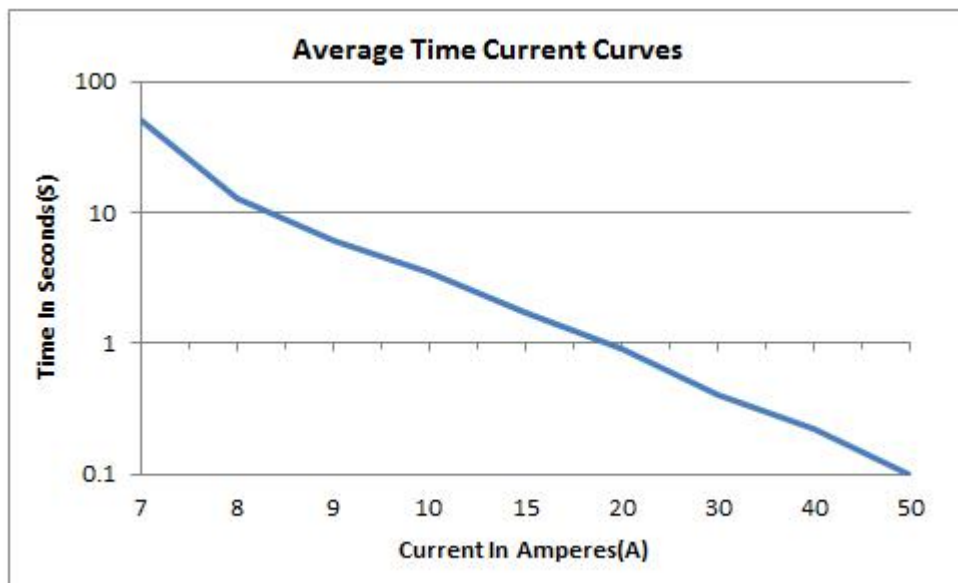

Packaging Quantity and Marking

Recommended Pad Layout (mm.)

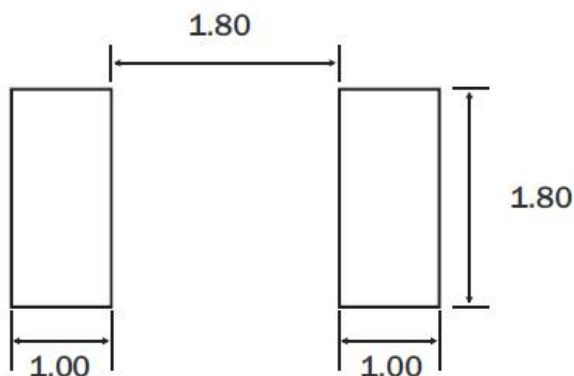

Device	Marking	Standard Quantity (pcs)
SMD1206-500-6V	B 500	3000

Tape Specifications:EIA-481-1(mm)

Governing Specifications	EIA481-1
W	8.0±0.3
F	3.5±0.05
E1	1.75±0.1
D0	1.55±0.05
D1	1.0±0.1
P0	4.0±0.1
P1	4.0±0.1
P2	2.0±0.05
A0	1.95±0.1
B0	3.65±0.1
T	0.2±0.1
K0	1.3±0.1
Leader min	390
Trailer min	160

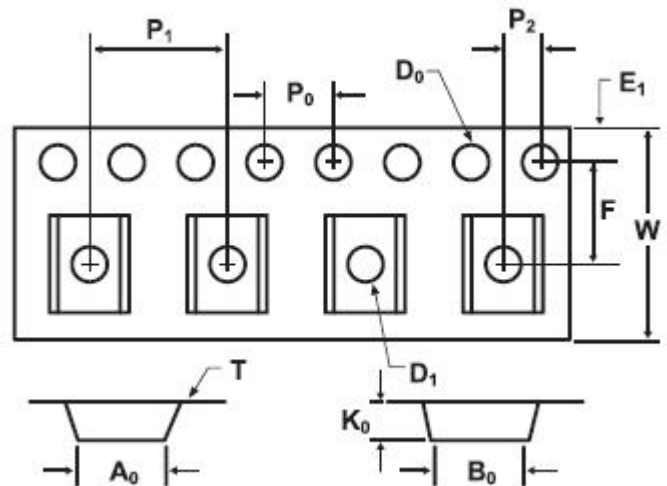

Reel Dimensions:EIA-481-1(mm)

Governing Specifications	EIA481-1
C	Φ 178±1.0
D	Φ 60.2±0.5
H	11.0±0.5
W	9.0±1.5

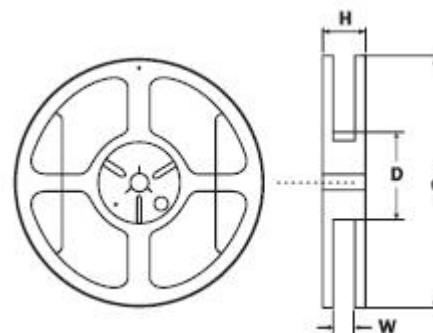

NOTE:

BNstar Co.,Ltd. makes no representations or warranties with respect to the accuracy or completeness of the contents of this publication and reserves the right to make changes to specifications and product descriptions at any time without notice. The products described in this document are not designed, intended, authorized or warranted for use as



Surface-Mount Device

SMD1206-500-6V



components in systems intended for surgical implant into the body, or in other applications intended to support or sustain life, or where malfunction of BNstar's product may result in direct physical harm, injury, or death to a person or severe property or environmental damage. BNstar Co.,Ltd., reserves the right to discontinue or make changes to its products at any time without notice.

Website: <http://www.bnstar.net>

For additional information, please contact your local Sales Representative.

©Copyright 2006, BNstar Co.,Ltd.



Operation beyond the maximum ratings or improper use may result in device damage and possible electrical arcing and flame. The devices are intended for protection against occasional over-current or over temperature fault conditions and should not be used when repeated fault conditions or prolonged trip events are anticipated. Device performance can be impacted negatively if devices are handled in a manner inconsistent with recommended electronic, thermal, and mechanical procedures for electronic components.

Contact information

BNSTAR NEW MATERIALS CO., LTD.
 130Meilong Road Shanghai, P.R.China
 Tel:86-021-64251576 Fax: 86-021-64250020
 EMAIL: info@bnstar.net

Rev. letter		Date	
Design	Check	Audit	Approve

单击下面可查看定价，库存，交付和生命周期等信息

[>>BNstar\(比诺星\)](#)