

TS21C HF
SMD 10/100 BASE-T Single Port Discrete
LAN Magnetics

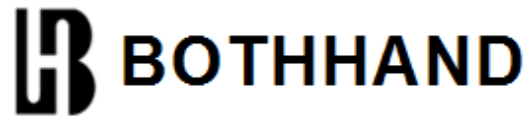

Feature

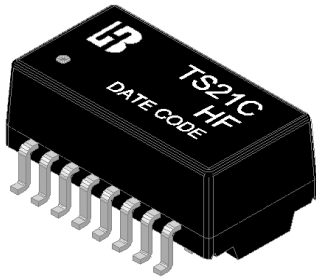

- Designed to meet IEEE 802.3u requirement, including 350uH OCL with 8mA bias.
- Complying with ROHS & Halogen Free requirements.
- Operating temperature range: 0°C to +70°C.
- Storage temperature range: -25°C to +85°C.

Electrical Specifications @ 25°C								
Part Number	Turns Ratio (±5%)		OCL (uH Min) @ 100KHz/0.1V with 8mA DC Bias	C _{ww} (pF Max)	L.L (uH Max)	DCR (Ω Max)		HI-POT
	1-3:16-14	6-8:11-9				1-3/6-8	16-14/11-9	
TS21C HF	1CT:1CT	1CT:1CT	350	28	0.5	0.9	1.1	AC1500V/1mA

Continue									
Part Number	Insertion Loss (dB Max)	Return Loss (dB Min)			Cross talk (dB Min)		DCMR (dB Min)		
		0.3-100MHz	30MHz	60MHz	80MHz	0.3-60MHz	60-100MHz	30MHz	60MHz
TS21C HF	-1.15	-18	-14	-12	-45	-35	-40	-35	-30

Schematic

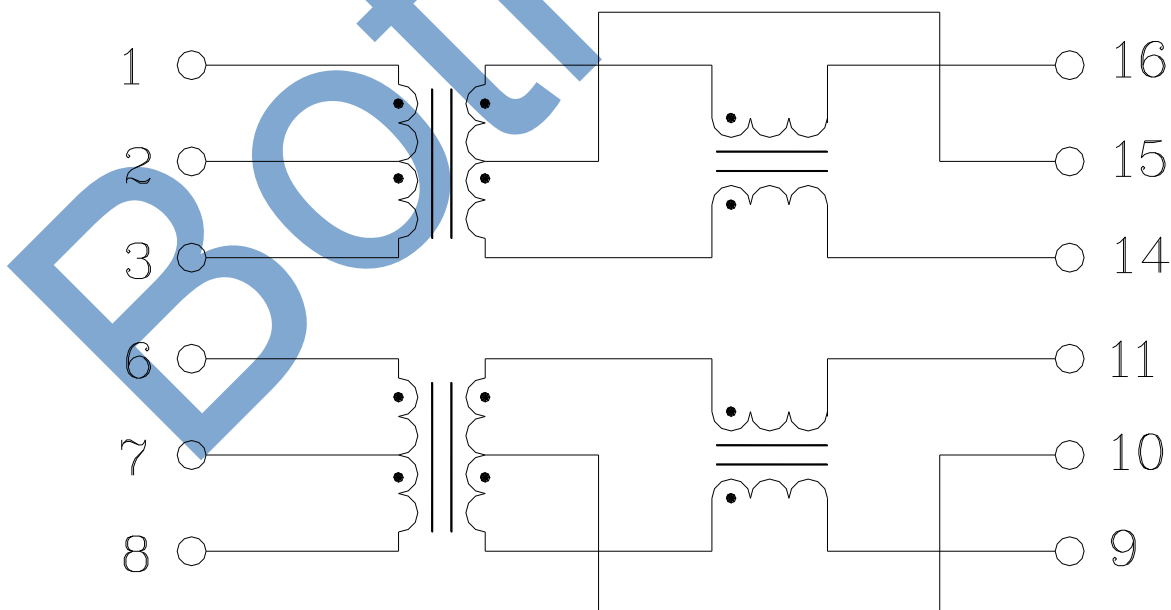

TS21C HF
SMD 10/100 BASE-T Single Port Discrete
LAN Magnetics



Mechanical

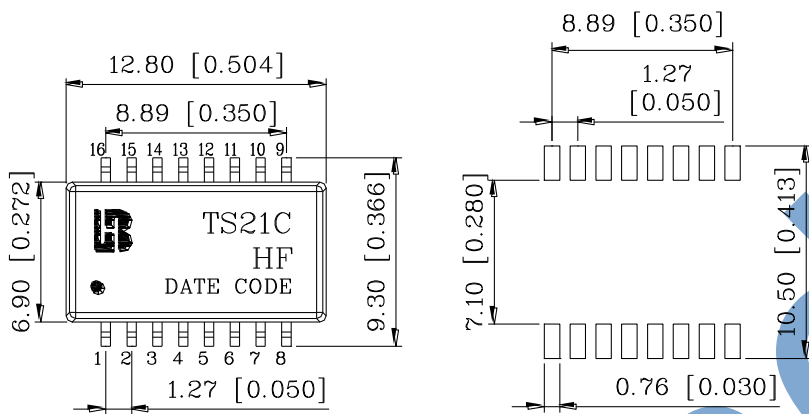

SUGGESTED PAD LAYOUT

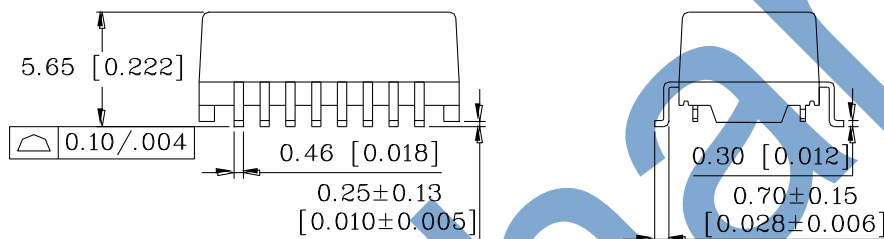

Units: mm [Inches] Tolerances: xx.xx ± 0.25 [0.010]
 0.xx ± 0.05 [0.002]

TS21C HF
SMD 10/100 BASE-T Single Port Discrete
LAN Magnetics

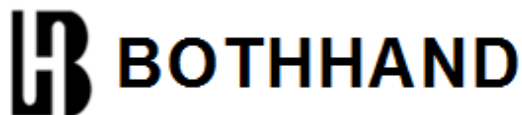

REEL PACKAGE

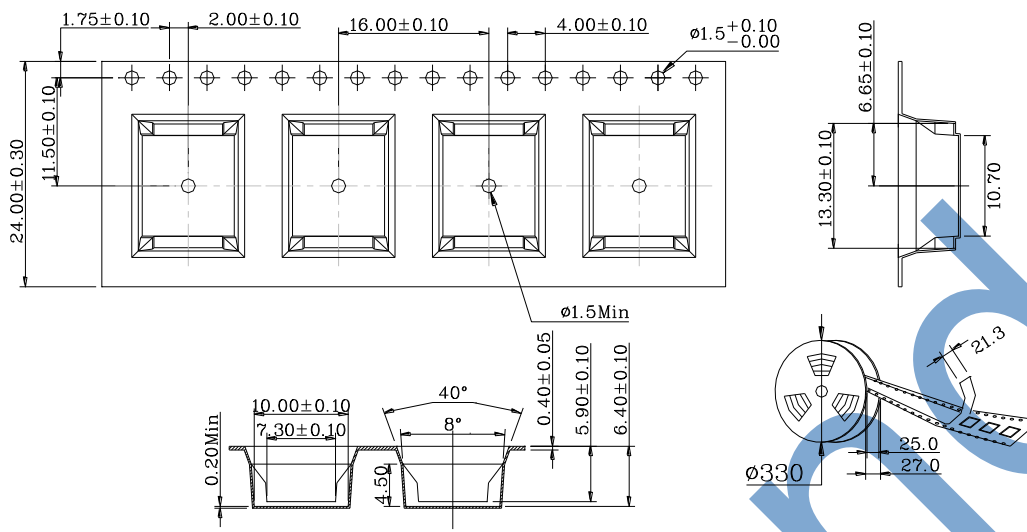

1. 10 sprocket hole pitch cumulative tolerance ±0.20
2. Material :Black conductive Polystyrene Alloy (UP-5000)
3. All dimensions meet EIA-481-2 requirements
4. Thickness :0.4±0.05mm
5. Component load per 13" reel :600 pcs
6. Packing length per 22" reel :32.5 Meters.
7. Carrier camber is within 1 mm in 250 mm.

CARTON PACKAGE



REEL

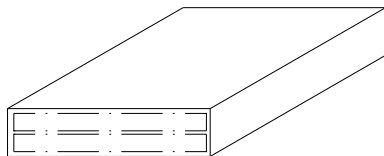

INNER BOX: 347x347x82

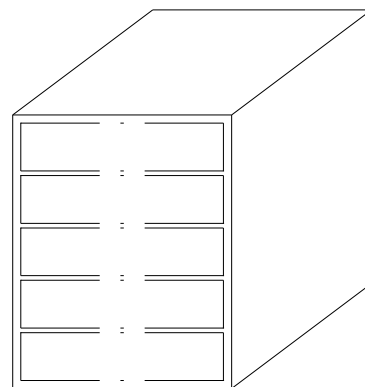

OUTER CARTON: 375x375x470

1. 1 Reel=600PCS
2. 1 INNER BOX=2Reel=1200PCS
3. 1 OUTER CARTON=5 INNER BOX=5x1200=6000PCS

单击下面可查看定价，库存，交付和生命周期等信息

[>>Bothhand\(帛汉\(帛漢\)\)](#)