

Feature



- Design for 2.5G/5G ethernet application.
- POE applications with 1A current capability.
- Complying with ROHS requirements.
- Operating temperature range: 0°C to +70°C.
- Storage temperature range: -25°C to +85°C.

Electrical Specifications @ 25°C

Part Number	Turns Ratio (±5%)		OCL (uH Min) @100KHz/0.1V	L.L (uH Max)	C _{ww} (pF Max)	DCR (Ω Max)	HI-POT
	TX	RX					
QVP9014R	1CT:1CT	1CT:1CT	180	0.5	28	1.0	AC1500V/1mA

Continue

Part Number	Insertion Loss (dB Max)		Return Loss (dB Min) @ Load 100Ω	
	1 ≦ f ≦ 100 MHz	100 < f ≦ 250 MHz	1 ≦ f ≦ 40 MHz	40 < f ≦ 250 MHz
QVP9014R	-1.0	-2.0	-16	-(16-10 log ₁₀ (f/40))

Continue

Part Number	Cross talk (dB Min)		DCMR (dB Min)	
	1 ≦ f ≦ 100 MHz	100 < f ≦ 250MHz	1 < f ≦ 30 MHz	30 < f ≦ 250 MHz
QVP9014R	$20 \log_{10} \left[10^{\frac{35.3-15 \log_{10}(f/100)}{-20}} + 2 \times 10^{\frac{43-20 \log_{10}(f/100)}{-20}} \right]$	-30	-48	-(44-19.2 log ₁₀ (f/50))

Schematic

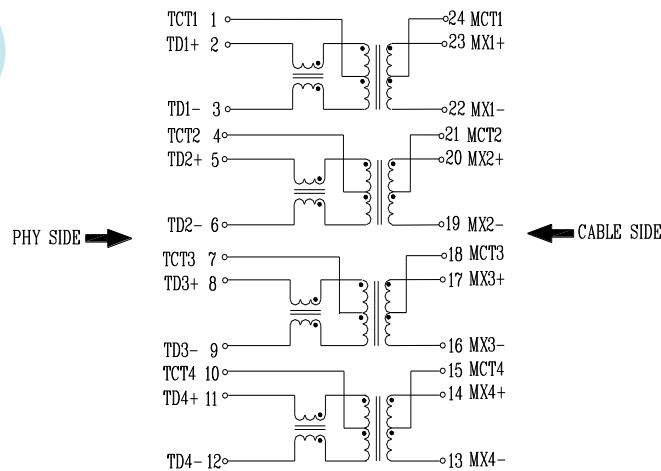

Mechanical

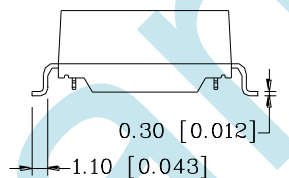
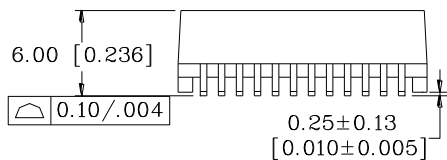
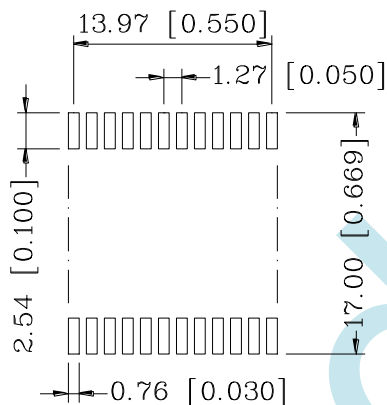
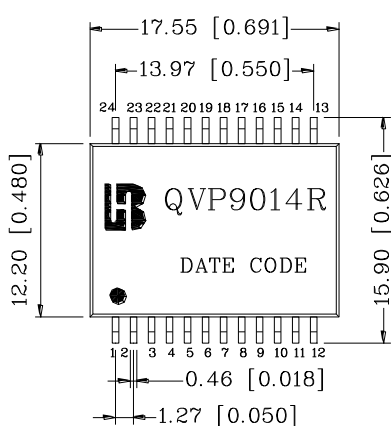

Units: mm [Inches] Tolerances: xx.xx ± 0.25 [0.010]
 0.xx ± 0.05 [0.002]

Bothhand

REEL PACKAGE

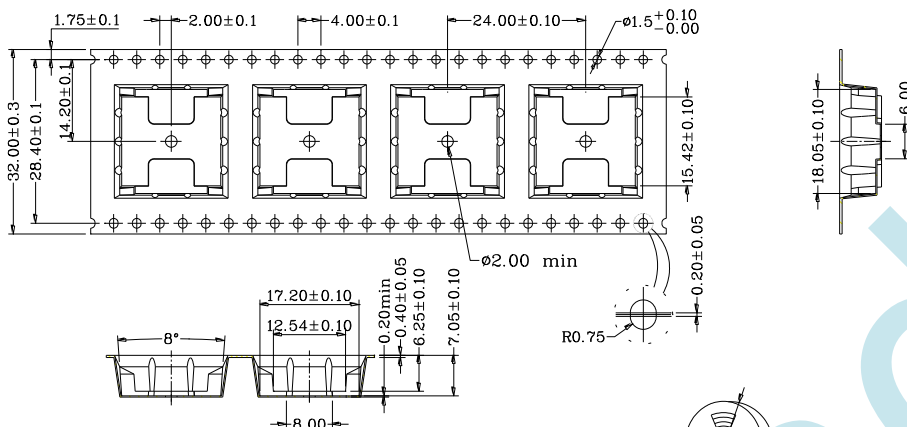

1. 10 sprocket hole pitch cumulative tolerance ±0.20
2. Material : Black Anti-Static polystyrene.
3. All dimensions meet EIA-481-3 requirements
4. Thickness : 0.40±0.05 mm
5. Component load per 13" reel : 350 pcs
6. Carrier camber is within 1 mm in 250 mm
7. Packing length per 22 reel : 29 Meters
8. Comply with Bothhand's <BHKP-W1-44-005> requirements

CARTON PACKAGE

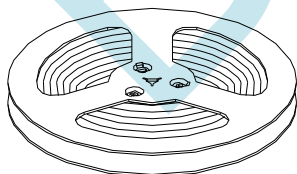

REEL

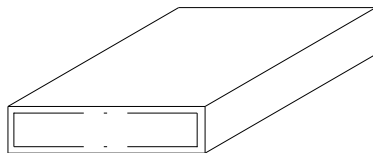

INNER BOX: 347x347x82

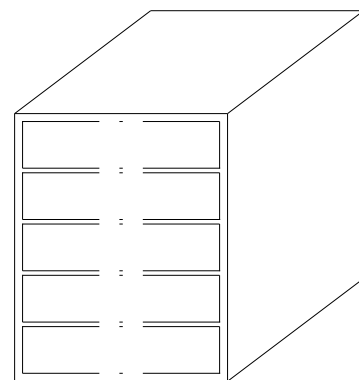

OUTER CARTON: 375x375x470

1. 1 Reel=350PCS
2. 1 INNER BOX=1 Reel=350 PCS
3. 1 OUTER CARTON=5 INNER BOX=5*350=1750 PCS

单击下面可查看定价，库存，交付和生命周期等信息

[>>Bothhand\(帛汉\(帛漢\)\)](#)