

**HG2PM109RN LF**  
**DIP 1000 BASE-T Dual Port Discrete**  
**LAN Magnetics**

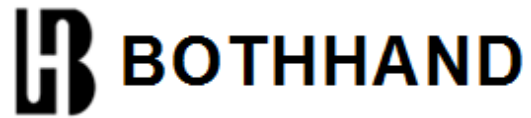

**Feature**

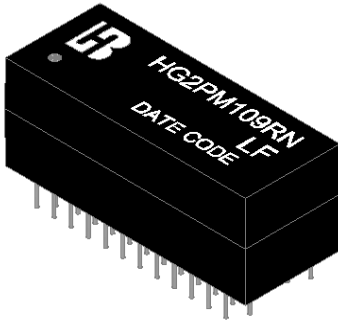

- Complying with IEEE 802.3ab standard for 1000BASE-T , full duplex applications.
- Supports 8 pairs of category 5 UTP cable.
- Cable interface for isolation and low common mode emissions.
- POE applications with 720mA current capability.
- Complying with ROHS requirements.
- Operating temperature range: 0°C to +70°C.
- Storage temperature range: -25°C to +85°C.

**Electrical Specifications @ 25°C**

Part Number	Turns Ratio (±5%)		OCL (uH Min) @100KHz/0.1V with 8mA DC Bias	L.L (uH Max)	Cw/w (pF Max)	DCR (Ω Max)	HI-POT
	TX	RX					
HG2PM109RN LF	1CT:1CT	1CT:1CT	350	0.5	28	1.2	AC1500V/1mA

**Continue**

Part Number	Insertion Loss (dB Max)	Return Loss (dB Min) @ Load 100Ω				
		1-100MHz	1-30MHz	40MHz	50MHz	60-80MHz
HG2PM109RN LF	-1.0	-18	-16	-14.08	-12.5	-10

**Continue**

Part Number	Cross talk (dB Min)			DCMR (dB Min)		
	30MHz	60MHz	100MHz	30MHz	60MHz	100MHz
HG2PM109RN LF	-40	-35	-30	-43	-37	-33

**Schematic**

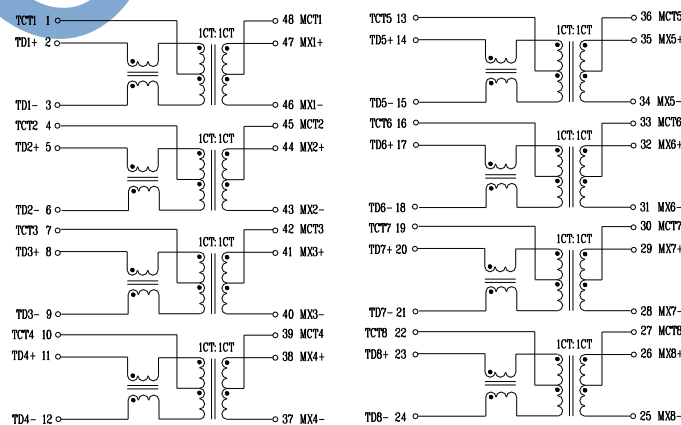

**HG2PM109RN LF**  
**DIP 1000 BASE-T Dual Port Discrete**  
**LAN Magnetics**

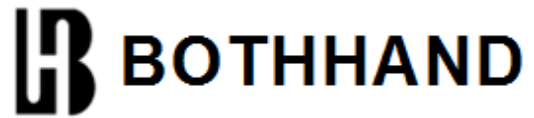

**Mechanical**

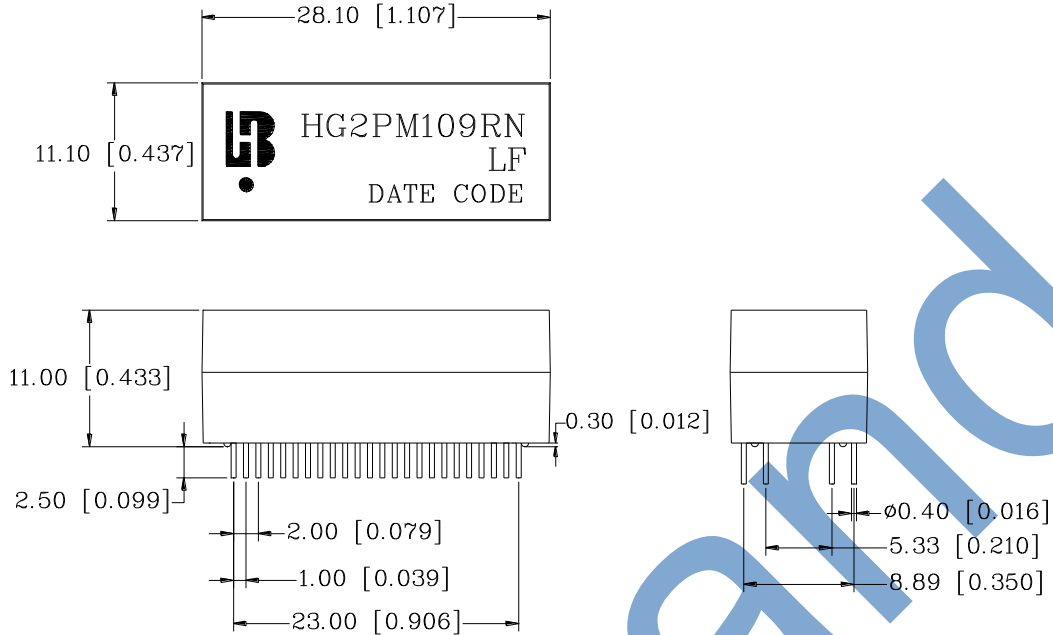

Units: mm[Inches] Tolerances : xx.xx±0.25[0.010]  
 0.xx±0.05[0.002]

**PCB Layout mounting Hole ( Top View)**

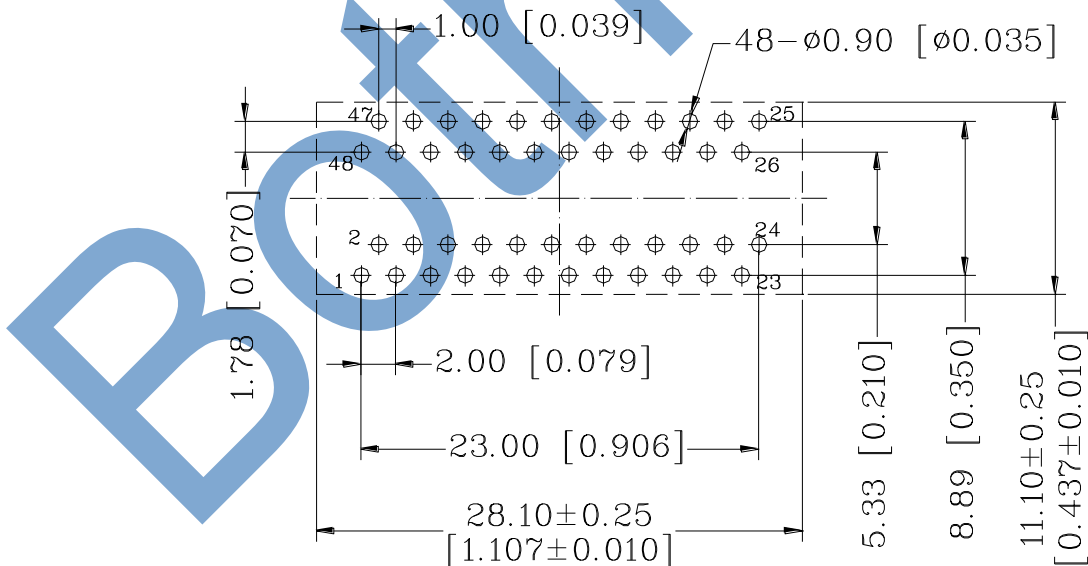

Unless otherwise specified,  
 all dimension tolerance are:  $\pm 0.08$  [ $\pm 0.003$ ]

**HG2PM109RN LF**  
**DIP 1000 BASE-T Dual Port Discrete**  
**LAN Magnetics**

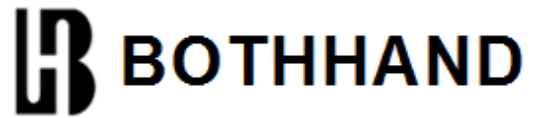

**PACKAGING**

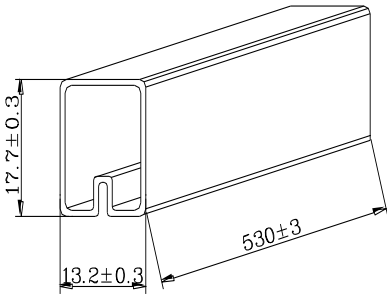

TUBE

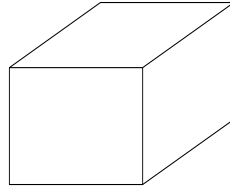

INNER BOX: 567x135x125

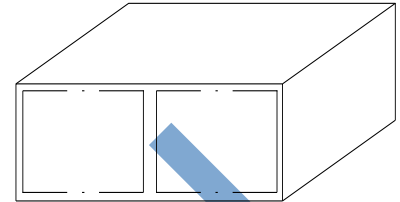

OUTER CARTON: 598x287x150

1. TUBE=18 PCS
2. INNER BOX=48TUBE= 48 x 18 = 864 PCS
3. OUTER CARTON=2 INNER  
CARTON= 864 x 2 = 1728 PCS

单击下面可查看定价，库存，交付和生命周期等信息

[>>Bothhand\(帛汉\(帛漢\)\)](#)